



Signify

# Lighting that's Ready-to-go when you are

The most complete stock offerings in the industry.

[signify.com/readytogo](https://www.signify.com/readytogo)

2022 Q1 Edition

**PHILIPS**

**LIGHTOLIER**  
by @ignify

**Day-Brite**  
**CFI**  
by @ignify

**HADCO**  
by @ignify

**ADVANCE**  
by @ignify

**LUMEC**  
by @ignify

**CHLORIDE**  
by @ignify

**GARDCO**  
by @ignify

**Stonco**  
by @ignify

# Ready-to-go

Our stocking solutions are now  
ready-to-go with your stock,  
design and specification needs



## Stock ready

Stock and Flow  
Ships in 2 days



## Design ready

Design Build  
Ships in 5-10 days



## Spec ready

Spec, Bid, Buy

# Table of contents



**Indoor luminaires**



**Exit and Emergency**



**Connected systems**



**Outdoor luminaires**



**Connected lighting systems**



**Retrofit kits**



**LED and Conventional lamps**



**Drivers**

## Indoor luminaires

Lightolier: Downlighting . . . . .	2
Lightolier: Recessed Multiples. . . . .	32
Lightolier: Track lighting . . . . .	34
DayBrite: Industrial . . . . .	42
DayBrite: Surface . . . . .	52
DayBrite: Battens . . . . .	56
DayBrite: Suspended . . . . .	70
DayBrite: Recessed . . . . .	71
Chloride: Exit signs . . . . .	84
Chloride: Emergency . . . . .	95
Philips: Connected lighting. . . . .	97
Interact Pro: Scalable Systems . . . . .	100

## Outdoor luminaires

Stonco: Garage & Canopy . . . . .	103
Stonco: Area Light . . . . .	104
Stonco: Floodlighting . . . . .	105
Stonco: Wall mount . . . . .	108
Stonco: Special purpose . . . . .	113
Hadco: Landscape lighting . . . . .	116
Hadco: Bollard lighting . . . . .	121
Lumec: Road lighting . . . . .	129
Gardco: Poles . . . . .	132
Gardco: Wall mount . . . . .	134
Gardco: Area & Site lighting . . . . .	135

## Retrofit & LED lamps

Philips: EvoKit retrofit kits . . . . .	137
Philips: LED tubes . . . . .	139
Philips: LED lamps . . . . .	146
Philips: LED HID replacement lamps. . . . .	165











































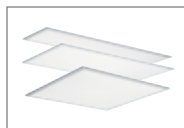













## Conventional lamps

Philips: CFL lamps . . . . .	173
Philips: CFL tubes . . . . .	176
Philips: HID lamps . . . . .	179
Philips: Halogen lamps . . . . .	182
Philips: Incandescent lamps . . . . .	183



















## Drivers & Ballasts

Advance: LED drivers . . . . .	185
Advance: Ballasts . . . . .	186

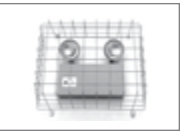
# Indoor luminaires

						
	Calculite LED 2	LyteProfile LED 8	UniFrame 11	Surface Mount Downlight 12	SlimSurface 13	Comm. Retrofit Dwnlt 16
						
Retrofit Downlight 17	LyteCaster LED 18	LyteCaster LED Accent 21	LyteCaster 23	CorePro LED Downlight 26	Mini Downlight/Gimbal 27	EasyLyte LED 28
						
Flat Downlight Select 30	OmniSpot LED 31	Alycon LED 33	BoldFlood LED 35	CorePro LED Track 36	Gimbal Rings 37	SpotLED 38
						
Track Head LED 39	Track Systems 40					
						
	HCY Sealed High Bay 42	FCY Value High Bay 43	FBX High Bay 44	FBY High Bay 46	FBD High Bay 48	HBO High Bay 49
						
RBX High Bay 50	LBD/LBN Low Bay 51	FlatPanel Gen2 52	Select Backlit Panel 53	APX High Bay 54	LED Dock Light 55	Fluxstream Family 56
						
NWL Wraparound 59	OW Wraparound 60	OWL Wraparound 61	VTC Sealed Strip 62	SLS Linkable Strip 63	N Narrow Strip 64	T Standard Strip 65
						
V3W Vaporlume 66	DW/V2 Vaporlume 67	1F/2F Industrial 68	IA/IS All-Purpose 69	SlimLux 70	DuaLED 71	ClearAppeal 72
						
EvoGrid 73	FluxGrid 76	TG LED 80	TG8 81	SoftTrace Gen2 82	Coffaire 83	

## Indoor luminaires (continued)

						
	44R Line Edge-lit LED 84	45V Line Edge-lit LED 85	55 Line Die-Cast LED 86	60 Line Die-Cast LED 87	Compac Units LED 88	DEB Series 89
						
Edge-Glo Edge-Lit LED 90	MSL Mini Step Light LED 91	Patron LED Wall Lite 92	Transfer Circuit Device 93	Value+ Family 94	Value+ Family 95	Accessory Wire Guards 96
						
	Philips Dynalite 97	Occuswitch 98	Wall box dimmers 99			
						
	Interact Pro Scalable System 100					

## Outdoor luminaires

						
	Garage & Canopy DualSelect 103	Area Light Gen2 Selectable 104	Slim Flood 105	Gnrl. Purpose Floods 106	Dusk to Dawn Gen3 107	Roughlyte 108
						
Low Profile Wall Light 109	Wall Light 110	Wall Pack Gen2 DualSelect 111	Tall Wall Pack 112	Security Light Selectable 113	LytePro Gen3 Wall Sconce 114	LED Bollard 115
						
	Path Lighting, Low Voltage 116	Path Lighting, Line Voltage 117	Accent Lighting, Line Voltage 118	Accent Lighting, LED Line Voltage 119	Accent Lighting, LED Low Voltage 120	Beacon & Bollard 121
						
Deck Lighting Low Voltage 122	Inground Lighting 123	Inground Lighting, LED Low Voltage 124	Step Lighting 125	Underwater Lighting 126	Wall Wash Lighting, LED Line Voltage 127	Landscape Lighting Accessories 128



## Outdoor luminaires (continued)



Roadway Security 129



RoadFocus 130



EcoForm Gen2 132



























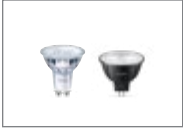









101L LED Wall Sconce 134



SolarForm 135

## Retrofit & LED lamps

		EvoKit Click LED Retrofit kits 137		CorePro InstantFit T5 & T8 (Type A/C) 138		MasterClass InstantFit T5 & T8 (Type A/C) 139		CorePro MainsFit T5 & T8 (Type B) 140		MasterClass MainsFit T8 (Type B) 142		CorePro FlexFit T8 (Type A+B) 143		
		MasterClass InstantFit T5 (Type A/C) 144		UniversalFit T8 145		CorePro PLED 146		MasterClass ExpertColor PAR 147		MasterClass TrueForce PAR 148		CorePro PAR 149		CorePro PAR 150
		MasterClass MR16 151		Title 20 MR16 152		CorePro GU10 & MR16 153		MasterClass AR111 154		CorePro Party A19 & PAR 155		MasterClass A-Shape 156		CorePro A-Shape 157
		Reflectors 158		Decorative A15 159		Globes G16.5 & G25 160		MasterClass Designer 161		Candles B11/BA11 & F15 162		UFO 163		MasterClass Specialty 164
		MasterClass Corn Cob 165		CorePro Corn Cob 166		TrueForce High Bay 168		High Bay/Low Bay 169		CorePro Wall Packs 170		TrueForce Post Top 171		

## Conventional lamps

		Integrated CFL 173		Pin-Based CFL 174		T5, T8 & T12 CFL 176		HID 179		Halogen Reflectors 182		Incandescent 183
---	---	--------------------	---	-------------------	---	----------------------	--	---------	---	------------------------	---	------------------

## LED Drivers

		LED Drivers 185		LED Ballasts 186
---	---	-----------------	---	------------------

# Expanding our capabilities

Now serving you in two new locations, Chicago & Atlanta!

Quick, reliable service out of our distribution centers.



## Find just what you need

Our Ready-to-go portfolio makes it easy to find just what you need with Stock Ready, Design Ready and Spec Ready options. Ready to go products are designed for easy ordering through Signify's MyLighting portal, easy to install with minimal steps, and competitively priced to meet the demands of budget conscious projects focused on cost and energy. Distributors can benefit from our Stock Ready program which offers deals on freight, guaranteed sales, price change reimbursement, delistment notifications, marketing support, merchandising, and more.

## Certifications and icons







## Your one-stop shop for any lighting need

Signify offers the most complete stock offering in the industry. We provide conventional and LED lamps, ballasts, drivers, retrofit kits, and indoor and outdoor stock luminaires. Save time and improve efficiencies by consolidating your stock purchases with Signify.

### Brands you can trust with a long history of excellence

As the global leader in lighting for more than 125 years, Signify has the know-how and most comprehensive portfolio to meet any application. We achieved 100% Carbon Neutrality in 2020. We are number 1 in conventional lamps, LED and Connected lighting. We have over 17,750 patents. We invest 4.8% of total sales in R&D which is two times our nearest competitor! Partnership is more than sales. Let's go together. Let's grow together. We are ready to go with you.

### Signify is leading the industry transition

**100%**

Carbon Neutral  
in 2020

**No. 1**

Connected Lighting,  
Conventional lamps  
& LED lamps

**\$7.3 B**

Sales  
~ 75% Professional

**> 64 M**

Connected  
light point

**4.8%**

Total sales invested in R&D  
2X our nearest competitor

**100+**

University  
partnerships

# The right solution for every need

Signify provides the solution to every lighting need whether it's lighting and connecting your public spaces, giving your commercial building an energy saving upgrade, or working on a yet to be constructed hospital, we've got you covered.

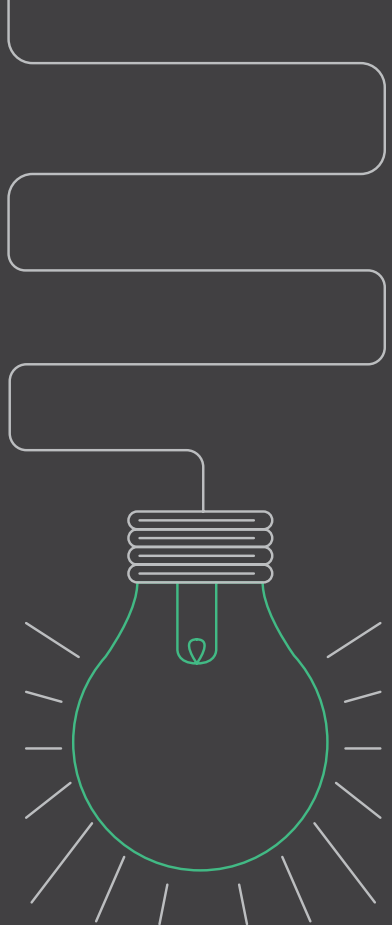

Government

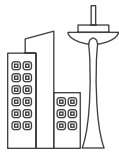

Cities



Offices

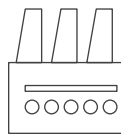

Industry



Education

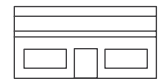

Retail



Ballasts  
and Drivers



Lamps  
and Tubes



Retrofit  
kits



Value-grade  
fixtures



Specification-grade  
lighting



Connected  
lighting

# Stock up on our new Field Selectable product line

With the unique convenience of adjustable color temperatures and/or lumen outputs, our new Field Selectable product lines make it easy to always have the right product for the job. Field Selectable products give you the added benefit of carrying one SKU versus multiple SKUs, keeping your inventory low and turns high. These product lines are priced right as part of our Ready-to-go offering.



Lumen  
Select Switch



CCT with  
Select Switch



Flat Downlight  
Select



Commercial  
Retrofit Downlight  
DualSelect



Sealed High Bay



Flat Panel  
Selectable Backlit Panel



Value High Bay

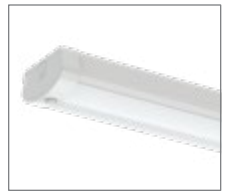

NWL LED  
Wraparound



Wall Pack  
Dual Select



Security Light



Area Light  
Select



Garage & Canopy  
DualSelect



CorePro MainsFit  
(Type B) T8  
with Selectable CCT



MasterClass  
Corn Cob  
with Selectable CCT

# Interact Pro scalable system

with integrated and  
connected sensor



## Make the leap from smart lighting to super smart lighting

- No restrictions on light points or building size
- Just add a gateway anytime and unlock more capabilities, no need to change or swap sensors
- Future proof your design and lay the right foundation
- Easy point-2-point commissioning sequence enables the installer to be more in control
- With its 3 tier approach Foundation → Advanced → Enterprise, you can start simple and lay the right foundation and scale up to the next tier to access more benefits by adding a gateway
- Unlock super savings and occupant comfort through adaptive dimming and dwell time features
- Get a complete view of the 3 tiers and compatible products at: [interact-lighting.com/interactproscalablesystem](https://interact-lighting.com/interactproscalablesystem)

## How are super savings delivered?

Adaptive dimming & dwell time feature enable the system to adapt to occupancy patterns in real time – delivering deep energy savings while maintaining occupancy comfort levels.

**Up to 75%**  
Savings w/o  
gateways

Boost energy savings  
**up to 85%**  
with gateways

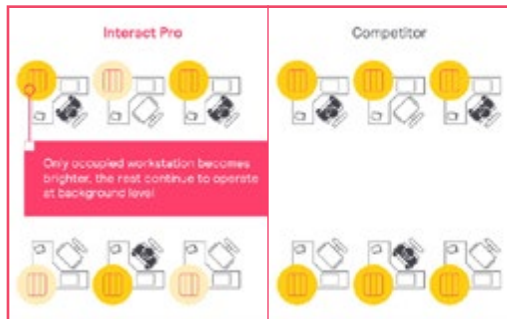

**Adaptive Dimming**

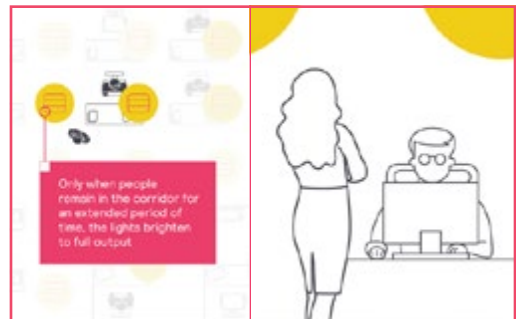

**Dwell Time**

# Connectivity is everywhere

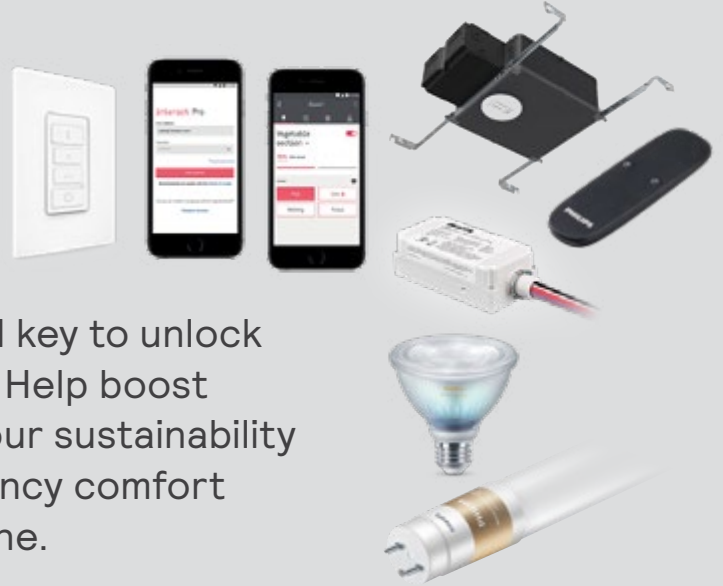

Connectivity is the future and key to unlock your smart building potential. Help boost your energy savings, reach your sustainability targets, and enhance occupancy comfort levels immediately from day one.

## Interact Pro scalable controls: Smart wireless devices for code and rebate compliancy and to maximize energy savings

- UID8451/10 wireless On/Off & dimmer switch
- SWS200 wireless scene selector to recall custom scenes
- System Bridge Accessory (SBA) for 0-10V and phase dimming integration
- RFSR10 wireless switch relay, ideal to control plug loads or integrate with 0-10V fixtures
- Optional IRT9015 handheld remote to help fastrack the commissioning process and minimize onsite setup time



**Day-Brite / CFI  
FluxStream w/SWZCS\***  
Simple, easy, convenient strip fixture

- Frosted acrylic diffuser provides wide light distribution and superior glare control
- Compact design for installation in tight spaces
- 2', 3', 4' & 8' tandem lengths available to accommodate many field applications



**Day-Brite / CFI  
FluxGrid w/SWZCS\***  
Familiar style, high quality, affordability

- Access to LED boards and drivers from below the ceiling increases maintenance convenience
- Ribbed or smooth lens options add subtle elegance to any space
- 3000-7400 lumens plus 4 color temperatures allow for flexibility



**Philips  
EvoKit retrofit kit\***  
Retrofit solution

- Accelerate project payback with low price, reduced scrap and 5 min installation time
- Energy efficiency up to 164 lm/W
- Fast configuration with Interact Pro App

\* Luminaires are configured with integral Interact Pro scalable sensor.

For additional Interact Ready product solutions visit [interact-lighting.com/en-us/what-is-possible/interact-pro/scalable-system](http://interact-lighting.com/en-us/what-is-possible/interact-pro/scalable-system)

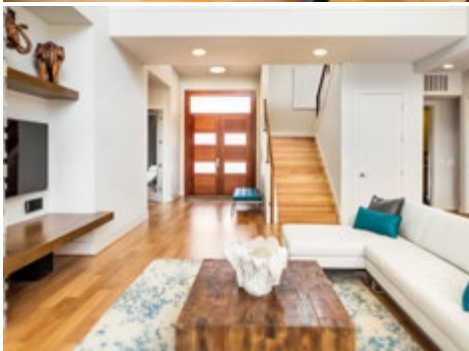

# Indoor luminaires

## Lightolier

- Alcyon LED
- BoldFlood LED
- Calculite LED
- Commercial Retrofit Downlight
- CorePro LED Downlight
- CorePro LED Track
- EasyLyte LED
- Flat Downlight Select
- Gimbal Rings
- LyteCaster (conventional)
- LyteCaster LED
- LyteCaster LED Accent
- LyteProfile LED
- Mini Gimbal and Mini Downlight
- OmniSpot LED
- Retrofit Downlight
- SlimSurface
- SpotLED
- Surface Mount Downlight
- Track Systems
- Track Head LED
- UniFrame

## Day-Brite

- 1F/2F Industrial
- APX High Bay
- ClearAppeal
- Coffaire
- DuaLED
- DW/V2 Vaporlume
- EvoGrid
- FBD High Bay
- FBX High Bay
- FBY High Bay
- FCY Value High Bay
- FluxGrid
- FluxStream Family
- FluxPanel Gen2
- HBO High Bay
- HCY Sealed High bay
- IA/IS All-Purpose
- LBD/LBN Low Bay
- LED Dock Light
- N Narrow Strip
- NWL Selectable Wraparound
- OW Wraparound
- OWL Wraparound
- RBX High Bay
- Selectable Backlit Panel
- SlimLux
- SLS Linkable Strip
- SofTrace Gen2
- T Standard Strip
- TG LED
- TG8
- V3W Vaporlume
- VTC Sealed Strip

## Chloride

- 44R Line Edge-lit LED
- 45V Line Edge-lit LED
- 55 Line Die-Cast LED
- 60 Line Die-Cast LED
- Accessory Wire Guards
- Compac Units LED
- DEB Series
- Edge-Glo Edge-Lit LED
- MSL Mini Step Light LED
- Patron LED Wall Light
- Transfer Circuit Device
- Value+ Family

## Philips Connected Lighting

- OccuSwitch
- Philips Dynalite
- Wall Box Dimmers

## Interact

- Interact Pro Scalable System

# Calculite LED

## Industry leading visual comfort

Calculite features excellent uniform illumination over time and patented installation flexibility.



## Why choose Calculite LED?

- Maximize visual appeal with three beam spread options to give the right distribution and light output
- Ultimate user comfort by providing 50° physical and 45° reflected cutoff, creating less brightness
- Uniform light and color consistency at an SDCM of 2
- Modular three piece design that makes servicing and upgrading convenient
- Installation efficiency accomplished by a tool-free install and quick connect technology



### Calculite LED

Catalog Number	UPC Code	Model Number	Product Description	Compliance	Case/Pallet Qty	Distribution Center
<b>Calculite LED 1.75" Downlights</b>						
■ C2L09DL927RE1	190096017157	912400543504	Frame - 900lm DL 90CRI 27K ELV	Energy Star	1/1	PA
■ C2L09DL927RZ10U	190096017119	912400535936	Frame - 900lm DL 90CRI 27K 0-10V	Energy Star	1/1	PA
■ C2L09DL930RE1	190096017164	912400543505	Frame - 900lm DL 90CRI 30K ELV	Energy Star	1/1	PA
● C2L09DL930RZ10U	190096017126	912400535937	Frame - 900lm DL 90CRI 30K 0-10V	Energy Star	1/210	PA
■ C2LDLCCDP	662057574776	912400470994	Trim - Downlight Reflector	Energy Star	1/294	Factory
■ C2LIC	662057634463	912400461267	Accessory - New Construction IC Frame	-	1/24	Factory
● C2LMP	662057611990	912400461268	Accessory - New Construction Non-IC Frame Mounting Pan	-	1/132	PA
■ CA2FMR	662057569970	912400463068	Accessory - Round 1.75" Mud-in Kit (for flush-mount installations)	-	12/480	CA
■ CA2X2FMR	662057625492	912400492075	Accessory - Square 1.75" Mud-in Kit (for flush-mount installations)	-	6/600	CA
<b>Calculite LED 3" Downlight Light Engines</b>						
■ C3L07930ME1R	784197686857	912401510598	Round 750lm 90CRI 3000K Medium Beam ELV 120V Remodeler	Energy Star	1/180	Factory
■ C3L07930MZ10UR	784197686864	912401510599	Round 750lm 90CRI 3000K Medium Beam 0-10V UNV Remodeler	Energy Star	1/180	Factory
■ C3L10927ME1	784197686826	912401510661	Round 1000lm 90CRI 2700K Medium Beam ELV 120V	Energy Star	1/180	Factory
■ C3L10930ME1R	784197686871	912401510601	Round 1000lm 90CRI 3000K Medium Beam ELV 120V Remodeler	Energy Star	1/180	Factory
■ C3L10930ME1S	784197666309	912400551360	Round 1000lm 90CRI 3000K Medium Beam ELV 120V Shallow	Energy Star	1/180	Factory
■ C3L10930MZ10U	784197666224	912400551352	Round 1000lm 90CRI 3000K Medium Beam 0-10V UNV	Energy Star	1/180	Factory
■ C3L10930MZ10UR	784197686888	912401510602	Round 1000lm 90CRI 3000K Medium Beam 0-10V UNV Remodeler	Energy Star	1/180	Factory
■ C3L10930MZ10US	784197686833	912401510603	Round 1000lm 90CRI 3000K Medium Beam 0-10V UNV Shallow	Energy Star	1/180	Factory
■ C3L109D2WWE1	784197690090	912400551563	Round 1000lm 90CRI 3000K-1800K Wide Beam 0-10V UNV	-	1/180	Factory
■ C3L10935ME1	784197690069	912401510747	Round 1000lm 90CRI 3500K Medium Beam ELV 120V	Energy Star	1/180	Factory

- Stock Ready (returnable)
- Design Ready (non-returnable)







# Calculite LED

(continued)

Catalog Number	UPC Code	Model Number	Product Description	Compliance	Case/Pallet Qty	Distribution Center
<b>Calculite LED 3" Downlight Light Engines (continued)</b>						
■ C3L10935MEIS	784197666316	912400551361	Round 1000lm 90CRI 3500K Medium Beam ELV 120V Shallow	Energy Star	1/180	Factory
■ C3L10935MZ10U	784197666231	912400551353	Round 1000lm 90CRI 3500K Medium Beam 0-10V UNV	Energy Star	1/180	Factory
■ C3L15930MZ10U	784197666248	912400551354	Round 1500lm 90CRI 3000K Medium Beam 0-10V UNV	Energy Star	1/180	Factory
■ C3L15935MZ10U	784197666255	912400551355	Round 1500lm 90CRI 3500K Medium Beam 0-10V UNV	Energy Star	1/180	Factory
■ C3L15935WZ10U	784197690120	912401510750	Round 1500lm 90CRI 3500K Wide Beam 0-10V UNV	Energy Star	1/180	Factory
■ C3L18935MZ10U	784197666279	912400551357	Round 1800lm 90CRI 3500K Medium Beam 0-10V UNV	Energy Star	1/180	Factory
■ C3L20930MZ10U	784197666262	912400551356	Round 2000lm 90CRI 3000K Medium Beam 0-10V UNV	Energy Star	1/180	Factory
■ C3L10930SZ10U	784197686840	912401510604	Square 1000lm 90CRI 3000K 0-10V UNV	Energy Star	1/180	Factory
■ C3L15930SZ10U	784197690106	912401510724	Square 1500lm 90CRI 3000K 0-10V UNV	Energy Star	1/180	Factory
■ C3L109D2WSZ10U	784197690083	912401510748	Square 1000lm 90CRI 3000K-1800K ELV 120V	-	1/180	Factory
■ C3L15935SZ10U	784197690113	912401510749	Square 1500lm 90CRI 3500K 0-10V UNV	Energy Star	1/180	Factory
■ C3L10935SZ10U	784197690076	912400551565	Square 1000lm 90CRI 3500K 0-10V UNV	Energy Star	1/180	Factory
<b>Calculite LED 3" Downlight Trims</b>						
■ C3RDLCC	784197666323	912400551362	Round Downlight Comfort Clear Finish White Flange	Energy Star	1/216	Factory
■ C3RDLCCP	784197686895	912401510612	Round Downlight Comfort Clear Finish Matching Flange	Energy Star	1/216	Factory
■ C3RDLCD	784197686901	912401510662	Round Downlight Comfort Clear Diffuse Finish White Flange	Energy Star	1/216	Factory
■ C3RDLCDP	784197690151	912401510754	Round Downlight Comfort Clear Diffuse Finish Matching Flange	Energy Star	1/216	Factory
■ C3RDLDPS	784197689988	912401510755	Round Downlight Aluminum Diffuse Finish Matching Flange Shallow	Energy Star	1/216	Factory
■ C3RDLWH	784197689995	912400551454	Round Downlight White Finish White Flange	Energy Star	1/216	Factory
■ C3RLWCC	784197666354	912400551365	Round Lensed Wall Wash Comfort Clear Finish White Flange	Energy Star	1/216	Factory
■ C3RLWCCP	784197686918	912401510613	Round Lensed Wall Wash Comfort Clear Finish Matching Flange	Energy Star	1/216	Factory
■ C3RLWWH	784197690007	912400551455	Round Lensed Wall Wash White Finish White Flange	Energy Star	1/216	Factory
■ C3SDLMCC	784197666330	912400551363	Square Downlight Medium Beam Comfort Clear Finish White Flange	Energy Star	1/216	Factory
■ C3SDLMCD	784197690014	912401510756	Square Downlight Medium Beam Comfort Clear Diffuse Finish White Flange	Energy Star	1/216	Factory
■ C3SDLMDPS	784197666408	912400551370	Square Downlight Medium Beam Aluminum Diffuse Finish Matching Flange Shallow	Energy Star	1/216	Factory
■ C3SDLMWH	784197690021	912401510757	Square Downlight Medium Beam White Finish White Flange	Energy Star	1/216	Factory
■ C3SDLMWTPS	784197690038	912401510767	Square Downlight Medium Beam Textured White Finish Matching Flange Shallow	Energy Star	1/216	Factory
■ C3SDLWCC	784197666347	912400551364	Square Downlight Wide Beam Comfort Clear Finish White Flange	Energy Star	1/216	Factory
■ C3SDLWCD	784197690045	912401510758	Square Downlight Wide Beam Comfort Clear Diffuse Finish White Flange	Energy Star	1/216	Factory
■ C3SLWCC	784197666361	912400551366	Square Lensed Wall Wash Comfort Clear Finish White Flange	Energy Star	1/216	Factory
<b>Calculite LED 3" Adjustable Accent Light Engines</b>						
■ C3RA079D2WNFZ10U	784197690168	912401510753	Round 700lm 90CRI 3000K-1800K Narrow Flood Beam 0-10V UNV	-	1/216	Factory
■ C3RA10930NFEIS	784197686925	912401510605	Round 1000lm 90CRI 3000K Narrow Flood Beam ELV 120V Shallow	Energy Star	1/216	Factory
■ C3RA10930NFZ10U	784197686932	912401510503	Round 1000lm 90CRI 3000K Narrow Flood Beam 0-10V UNV	Energy Star	1/216	Factory
■ C3RA10935NFZ10U	784197686949	912401510607	Round 1000lm 90CRI 3500K Narrow Flood Beam 0-10V UNV	Energy Star	1/216	Factory
■ C3RA10935SPZ10UR	784197690175	912401510752	Round 1000lm 90CRI 3500K Spot Beam 0-10V UNV Remodeler	Energy Star	1/216	Factory
■ C3RA15930NFZ10U	784197686956	912401510608	Round 1500lm 90CRI 3000K Narrow Flood Beam 0-10V UNV	Energy Star	1/216	Factory
■ C3RA15935NFZ10U	784197686963	912401510508	Round 1500lm 90CRI 3500K Narrow Flood Beam 0-10V UNV	Energy Star	1/216	Factory
■ C3SA10930NFEIS	784197686970	912401510614	Square 1000lm 90CRI 3000K Narrow Flood Beam ELV 120V Shallow	-	1/216	Factory
■ C3SA10930NFZ10U	784197686987	912401510615	Square 1000lm 90CRI 3000K Narrow Flood Beam 0-10V UNV	-	1/216	Factory
■ C3SA10935NFZ10U	784197686994	912401510616	Square 1000lm 90CRI 3500K Narrow Flood Beam 0-10V UNV	-	1/216	Factory
■ C3SA15930NFZ10U	784197687007	912401510617	Square 1500lm 90CRI 3000K Narrow Flood Beam 0-10V UNV	-	1/216	Factory
■ C3SA15935NFZ10U	784197687014	912401510618	Square 1500lm 90CRI 3500K Narrow Flood Beam 0-10V UNV	-	1/216	Factory
<b>Calculite LED 3" Adjustable Accent Trims</b>						
■ C3RACC	784197687021	912401510512	Round Adjustable Comfort Clear Finish White Flange	Energy Star	1/216	Factory
■ C3RACCP	784197687038	912401510504	Round Adjustable Comfort Clear Finish Matching Flange	Energy Star	1/216	Factory
■ C3RACD	784197690182	912401510737	Round Adjustable Comfort Clear Diffuse Finish White Flange	Energy Star	1/216	Factory
■ C3RACDP	784197690199	912401510759	Round Adjustable Comfort Clear Diffuse Finish Matching Flange	Energy Star	1/216	Factory
■ C3RADP	784197690205	912401510760	Round Adjustable Aluminum Diffuse Finish Matching Flange	Energy Star	1/216	Factory

- Stock Ready (returnable)
- Design Ready (non-returnable)



# Calculite LED

(continued)

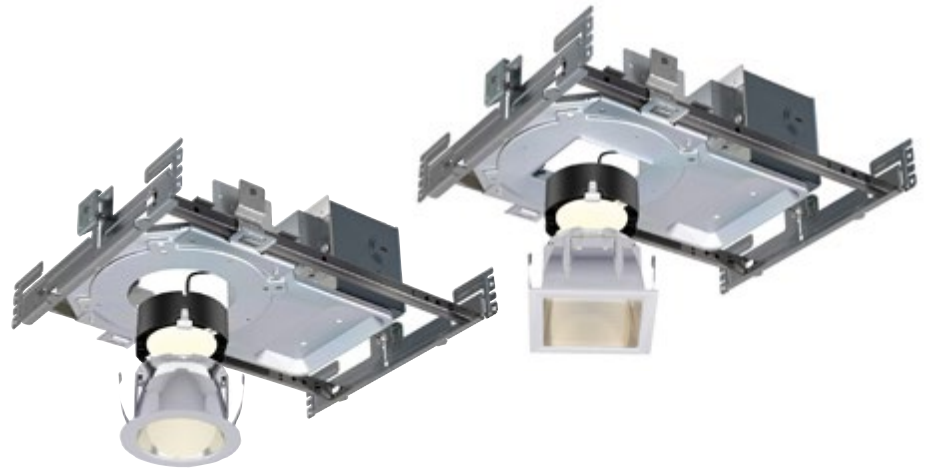

Catalog Number	UPC Code	Model Number	Product Description	Compliance	Case/Pallet Qty	Distribution Center
<b>Calculite LED 3" Adjustable Accent Trims (continued)</b>						
■ C3RAWH	784197690212	912401510761	Round Adjustable White Finish White Flange	Energy Star	1/216	Factory
■ C3RAWTP	784197690229	912401510762	Round Adjustable White Textured Finish Matching Flange	Energy Star	1/216	Factory
■ C3SACC	784197687045	912401510515	Square Adjustable Comfort Clear Finish White Flange	-	1/216	Factory
<b>Calculite LED 3" Accessories</b>						
■ CA3RAAFT	190096017942	912400543602	Round 3" Mud-in Kit (for flush-mount installations)	-	1/1	CA
■ CA3SAAFT	190096017959	912400543603	Square 3" Mud-in Kit (for flush-mount installations)	-	1/1	CA
<b>Calculite LED 4" Light Engines</b>						
■ C4L05830MZ10U	662057974477	912400538780	500lm 80CRI 3000K Medium Beam 0-10V UNV	-	1/180	Factory
■ C4L05830NZ10U	662057974439	912400538776	500lm 80CRI 3000K Narrow Beam 0-10V UNV	-	1/180	Factory
■ C4L05830WZ10U	662057974514	912400538784	500lm 80CRI 3000K Wide Beam 0-10V UNV	-	1/180	Factory
■ C4L05835MZ10U	662057974484	912400538781	500lm 80CRI 3500K Medium Beam 0-10V UNV	-	1/180	Factory
■ C4L05835NZ10U	662057974446	912400538777	500lm 80CRI 3500K Narrow Beam 0-10V UNV	-	1/180	Factory
■ C4L05835WZ10U	662057974521	912400538785	500lm 80CRI 3500K Wide Beam 0-10V UNV	-	1/180	Factory
■ C4L05840MZ10U	662057974491	912400538782	500lm 80CRI 4000K Medium Beam 0-10V UNV	-	1/180	TN
■ C4L05840NZ10U	662057974453	912400538778	500lm 80CRI 4000K Narrow Beam 0-10V UNV	-	1/180	Factory
■ C4L05840WZ10U	662057974538	912400538786	500lm 80CRI 4000K Wide Beam 0-10V UNV	-	1/180	Factory
■ C4L10830MZ10U	662057974835	912400538817	1000lm 80CRI 3000K Medium Beam 0-10V UNV	Energy Star	1/180	TN
■ C4L10830NZ10U	662057974798	912400538813	1000lm 80CRI 3000K Narrow Beam 0-10V UNV	Energy Star	1/180	Factory
■ C4L10830WZ10U	662057974873	912400538821	1000lm 80CRI 3000K Wide Beam 0-10V UNV	Energy Star	1/180	Factory
■ C4L10835MZ10U	662057974842	912400538818	1000lm 80CRI 3500K Medium Beam 0-10V UNV	Energy Star	1/180	CA, TN, PA
■ C4L10835NZ10U	662057974804	912400538814	1000lm 80CRI 3500K Narrow Beam 0-10V UNV	Energy Star	1/180	Factory
■ C4L10835WZ10U	662057974880	912400538822	1000lm 80CRI 3500K Wide Beam 0-10V UNV	Energy Star	1/180	TN
■ C4L10840MZ10U	662057974859	912400538819	1000lm 80CRI 4000K Medium Beam 0-10V UNV	Energy Star	1/180	Factory
■ C4L10840NZ10U	662057974811	912400538815	1000lm 80CRI 4000K Narrow Beam 0-10V UNV	Energy Star	1/180	Factory
■ C4L10840WZ10U	662057974897	912400538823	1000lm 80CRI 4000K Wide Beam 0-10V UNV	Energy Star	1/180	Factory
■ C4L15830MZ10U	662057975344	912400538865	1500lm 80CRI 3000K Medium Beam 0-10V UNV	Energy Star	1/180	Factory
■ C4L15830NZ10U	662057975306	912400538861	1500lm 80CRI 3000K Narrow Beam 0-10V UNV	Energy Star	1/180	Factory
■ C4L15830WZ10U	662057975382	912400538869	1500lm 80CRI 3000K Wide Beam 0-10V UNV	Energy Star	1/180	Factory
■ C4L15835MZ10U	662057975351	912400538866	1500lm 80CRI 3500K Medium Beam 0-10V UNV	Energy Star	1/180	TN, PA
■ C4L15835NZ10U	662057975313	912400538862	1500lm 80CRI 3500K Narrow Beam 0-10V UNV	Energy Star	1/180	Factory
■ C4L15835WZ10U	662057975399	912400538870	1500lm 80CRI 3500K Wide Beam 0-10V UNV	Energy Star	1/180	Factory
■ C4L15840NZ10U	662057975320	912400538863	1500lm 80CRI 4000K Narrow Beam 0-10V UNV	Energy Star	1/180	Factory
■ C4L15840WZ10U	662057975405	912400538871	1500lm 80CRI 4000K Wide Beam 0-10V UNV	Energy Star	1/180	TN
■ C4L20830MZ10U	662057975825	912400538914	2000lm 80CRI 3000K Medium Beam 0-10V UNV	Energy Star	1/180	Factory
■ C4L20830NZ10U	662057975788	912400538910	2000lm 80CRI 3000K Narrow Beam 0-10V UNV	Energy Star	1/180	Factory
■ C4L20830WZ10U	662057975863	912400538918	2000lm 80CRI 3000K Wide Beam 0-10V UNV	Energy Star	1/180	PA
■ C4L20835MZ10U	662057975832	912400538915	2000lm 80CRI 3500K Medium Beam 0-10V UNV	Energy Star	1/180	Factory
■ C4L20835NZ10U	662057975795	912400538911	2000lm 80CRI 3500K Narrow Beam 0-10V UNV	Energy Star	1/180	Factory
■ C4L20835WZ10U	662057975870	912400538919	2000lm 80CRI 3500K Wide Beam 0-10V UNV	Energy Star	1/180	Factory
■ C4L25830MZ10U	662057975849	912400538916	2500lm 80CRI 4000K Medium Beam 0-10V UNV	Energy Star	1/180	TN
■ C4L20840NZ10U	662057975801	912400538912	2000lm 80CRI 4000K Narrow Beam 0-10V UNV	Energy Star	1/180	Factory
■ C4L20840WZ10U	662057975887	912400538920	2000lm 80CRI 4000K Wide Beam 0-10V UNV	Energy Star	1/180	Factory
■ C4L25830MZ10U	662057976600	912400538962	2500lm 80CRI 3000K Medium Beam 0-10V UNV	Energy Star	1/180	Factory
■ C4L25830NZ10U	662057976563	912400538958	2500lm 80CRI 3000K Narrow Beam 0-10V UNV	Energy Star	1/180	Factory
■ C4L25830WZ10U	662057976648	912400538966	2500lm 80CRI 3000K Wide Beam 0-10V UNV	Energy Star	1/180	Factory
■ C4L25835MZ10U	662057976617	912400538963	2500lm 80CRI 3500K Medium Beam 0-10V UNV	Energy Star	1/180	CA
■ C4L25835NZ10U	662057976570	912400538959	2500lm 80CRI 3500K Narrow Beam 0-10V UNV	Energy Star	1/180	Factory
■ C4L25835WZ10U	662057976655	912400538967	2500lm 80CRI 3500K Wide Beam 0-10V UNV	Energy Star	1/180	Factory

- Stock Ready (returnable)
- Design Ready (non-returnable)





# Calculite LED

(continued)

Catalog Number	UPC Code	Model Number	Product Description	Compliance	Case/Pallet Qty	Distribution Center
<b>Calculite LED 4" Light Engine (continued)</b>						
■ C4L25840MZ10U	662057976624	912400538964	2500lm 80CRI 4000K Medium Beam 0-10V UNV	Energy Star	1/180	Factory
■ C4L25840NZ10U	662057976587	912400538960	2500lm 80CRI 4000K Narrow Beam 0-10V UNV	Energy Star	1/180	Factory
■ C4L25840WZ10U	662057976662	912400538968	2500lm 80CRI 4000K Wide Beam 0-10V UNV	Energy Star	1/180	Factory
■ C4L30830MZ10U	190096027668	912400539011	3000lm 80CRI 3000K Medium Beam 0-10V UNV	Energy Star	1/180	Factory
■ C4L30830NZ10U	662057977096	912400539007	3000lm 80CRI 3000K Narrow Beam 0-10V UNV	Energy Star	1/180	Factory
■ C4L30830WZ10U	662057977171	912400539015	3000lm 80CRI 3000K Wide Beam 0-10V UNV	Energy Star	1/180	Factory
■ C4L30835MZ10U	662057977140	912400539012	3000lm 80CRI 3500K Medium Beam 0-10V UNV	Energy Star	1/180	PA
■ C4L30835NZ10U	662057977102	912400539008	3000lm 80CRI 3500K Narrow Beam 0-10V UNV	Energy Star	1/180	Factory
■ C4L30835WZ10U	662057977188	912400539016	3000lm 80CRI 3500K Wide Beam 0-10V UNV	Energy Star	1/180	Factory
■ C4L30840MZ10U	662057977157	912400539013	3000lm 80CRI 4000K Medium Beam 0-10V UNV	Energy Star	1/180	Factory
■ C4L30840NZ10U	662057977119	912400539009	3000lm 80CRI 4000K Narrow Beam 0-10V UNV	Energy Star	1/180	Factory
■ C4L30840WZ10U	662057977195	912400539017	3000lm 80CRI 4000K Wide Beam 0-10V UNV	Energy Star	1/180	Factory
<b>Calculite LED 4" Trims</b>						
■ C4RDLCC	662057972008	912400539321	Round Downlight Comfort Clear Finish White Flange	-	1/216	CA, TN, PA
■ C4RDLCCF	662057972398	912400539332	Round Downlight Comfort Clear Finish Flangeless	Energy Star	1/216	TN
■ C4RDLCCP	662057972343	912400539327	Round Downlight Comfort Clear Finish Matching Flange	Energy Star	1/216	Factory
■ C4RDLCD	662057972305	912400539323	Round Downlight Comfort Clear Diffuse Finish White Flange	Energy Star	1/216	Factory
■ C4RDLCDF	662057972411	912400539334	Round Downlight Comfort Clear Diffuse Finish Flangeless	Energy Star	1/216	Factory
■ C4RDLCDP	662057972367	912400539329	Round Downlight Comfort Clear Diffuse Finish Matching Flange	Energy Star	1/216	Factory
■ C4RDLCCL	662057972299	912400539322	Round Downlight Specular Clear Finish White Flange	Energy Star	1/216	Factory
■ C4RDLCCLF	662057972404	912400539333	Round Downlight Specular Clear Finish Flangeless	Energy Star	1/216	Factory
■ C4RDLCCLP	662057972350	912400539328	Round Downlight Specular Clear Finish Matching Flange	Energy Star	1/216	Factory
■ C4RDLWH	190096022151	912400539325	Round Downlight White Finish White Flange	Energy Star	1/216	Factory
■ C4RDLWHF	190096022175	912400539336	Round Downlight White Finish Flangeless	Energy Star	1/216	Factory
■ C4RWWCCF	662057965208	912400539349	Round Wall Wash Comfort Clear Finish Flangeless	Energy Star	1/216	Factory
■ C4RWWCCP	662057965154	912400539344	Round Wall Wash Comfort Clear Finish Matching Flange	Energy Star	1/216	Factory
■ C4RWWCD	662057965024	912400539340	Round Wall Wash Comfort Clear Diffuse Finish White Flange	Energy Star	1/216	Factory
■ C4RWWCDF	662057965222	912400539351	Round Wall Wash Comfort Clear Diffuse Finish Flangeless	Energy Star	1/216	Factory
■ C4RWWCDP	662057965178	912400539346	Round Wall Wash Comfort Clear Diffuse Finish Matching Flange	Energy Star	1/216	Factory
■ C4RWWCL	662057965017	912400539339	Round Wall Wash Specular Clear Finish White Flange	Energy Star	1/216	Factory
■ C4RWWCLF	662057965215	912400539350	Round Wall Wash Specular Clear Finish Flangeless	Energy Star	1/216	Factory
■ C4SDLNMC	662057972497	912400539716	Square Downlight Narrow/Wide Beam Comfort Clear Finish White Flange	Energy Star	1/96	TN
<b>Calculite LED 4" Accessories</b>						
● CA4RFT	190096030293	912400538534	Round 4" Mud-in Kit (for flush-mount installations)	-	1/1	PA
● CA4SFT	190096030309	912400538535	Square 4" Mud-in Kit (for flush-mount installations)	-	1/1	PA
<b>Calculite LED 4" Adjustable Accent</b>						
■ C4LA15NUZ10V	662057914411	912400527632	Frame - New Construction Z10V 120-277V	-	1/30	Factory
■ C4L15A35K8FL	662057914206	912400527615	Engine - 1500lm 3500K 80CRI Flood Beam	-	1/224	Factory
■ C4LACCLW	662057914046	912400527599	Trim - Round Adjustable Comfort Clear Finish White Flange	-	1/294	Factory
<b>Calculite LED 6" Light Engines</b>						
■ C6L10830MZ10U	662057977614	912400539059	1000lm 80CRI 3000K Medium Beam 0-10V UNV	Energy Star	1/180	Factory
■ C6L10830NZ10U	662057977577	912400539055	1000lm 80CRI 3000K Narrow Beam 0-10V UNV	Energy Star	1/180	Factory
■ C6L10830WZ10U	662057977652	912400539063	1000lm 80CRI 3000K Wide Beam 0-10V UNV	Energy Star	1/180	Factory
■ C6L10835MZ10U	662057977621	912400539060	1000lm 80CRI 3500K Medium Beam 0-10V UNV	Energy Star	1/180	Factory
■ C6L10835NZ10U	662057977584	912400539056	1000lm 80CRI 3500K Narrow Beam 0-10V UNV	Energy Star	1/180	Factory
■ C6L10835WZ10U	662057977669	912400539064	1000lm 80CRI 3500K Wide Beam 0-10V UNV	Energy Star	1/180	Factory
■ C6L10840MZ10U	662057977638	912400539061	1000lm 80CRI 4000K Medium Beam 0-10V UNV	Energy Star	1/180	TN
■ C6L10840NZ10U	662057977591	912400539057	1000lm 80CRI 4000K Narrow Beam 0-10V UNV	Energy Star	1/180	Factory
■ C6L10840WZ10U	662057977676	912400539065	1000lm 80CRI 4000K Wide Beam 0-10V UNV	Energy Star	1/180	TN

- Stock Ready (returnable)
- Design Ready (non-returnable)



# Calculite LED

(continued)



Catalog Number	UPC Code	Model Number	Product Description	Compliance	Case/Pallet Qty	Distribution Center
<b>Calculite LED 6" Light Engines (continued)</b>						
■ C6L15830MZ10U	662057978093	912400539108	1500lm 80CRI 3000K Medium Beam 0-10V UNV	Energy Star	1/180	Factory
■ C6L15830NZ10U	662057978055	912400539104	1500lm 80CRI 3000K Narrow Beam 0-10V UNV	Energy Star	1/180	PA
■ C6L15830WZ10U	662057978130	912400539112	1500lm 80CRI 3000K Wide Beam 0-10V UNV	Energy Star	1/180	Factory
■ C6L15835MZ10U	662057978109	912400539109	1500lm 80CRI 3500K Medium Beam 0-10V UNV	Energy Star	1/180	TN, PA
■ C6L15835NZ10U	662057978062	912400539105	1500lm 80CRI 3500K Narrow Beam 0-10V UNV	Energy Star	1/180	Factory
■ C6L15835WZ10U	662057978147	912400539113	1500lm 80CRI 3500K Wide Beam 0-10V UNV	Energy Star	1/180	Factory
■ C6L15840MZ10U	662057978116	912400539110	1500lm 80CRI 4000K Medium Beam 0-10V UNV	Energy Star	1/180	Factory
■ C6L15840NZ10U	662057978079	912400539106	1500lm 80CRI 4000K Narrow Beam 0-10V UNV	Energy Star	1/180	Factory
■ C6L15840WZ10U	662057978154	912400539114	1500lm 80CRI 4000K Wide Beam 0-10V UNV	Energy Star	1/180	Factory
■ C6L20830MZ10U	662057979533	912400539156	2000lm 80CRI 3000K Medium Beam 0-10V UNV	Energy Star	1/180	Factory
■ C6L20830NZ10U	662057979083	912400539152	2000lm 80CRI 3000K Narrow Beam 0-10V UNV	Energy Star	1/180	Factory
■ C6L20830WZ10U	662057979922	912400539160	2000lm 80CRI 3000K Wide Beam 0-10V UNV	Energy Star	1/180	Factory
■ C6L20835MZ10U	662057979625	912400539157	2000lm 80CRI 3500K Medium Beam 0-10V UNV	Energy Star	1/180	TN, PA
■ C6L20835NZ10U	662057979090	912400539153	2000lm 80CRI 3500K Narrow Beam 0-10V UNV	Energy Star	1/180	Factory
■ C6L20835WZ10U	662057979939	912400539161	2000lm 80CRI 3500K Wide Beam 0-10V UNV	Energy Star	1/180	Factory
■ C6L20840MZ10U	662057979632	912400539158	2000lm 80CRI 4000K Medium Beam 0-10V UNV	Energy Star	1/180	Factory
■ C6L20840NZ10U	662057979106	912400539154	2000lm 80CRI 4000K Narrow Beam 0-10V UNV	Energy Star	1/180	Factory
■ C6L20840WZ10U	662057979977	912400539162	2000lm 80CRI 4000K Wide Beam 0-10V UNV	Energy Star	1/180	Factory
■ C6L25830MZ10U	662057982038	912400539192	2500lm 80CRI 3000K Medium Beam 0-10V UNV	Energy Star	1/180	Factory
■ C6L25830NZ10U	662057981857	912400539188	2500lm 80CRI 3000K Narrow Beam 0-10V UNV	Energy Star	1/180	Factory
■ C6L25830WZ10U	662057982182	912400539196	2500lm 80CRI 3000K Wide Beam 0-10V UNV	Energy Star	1/180	Factory
■ C6L25835MZ10U	662057982151	912400539193	2500lm 80CRI 3500K Medium Beam 0-10V UNV	Energy Star	1/180	Factory
■ C6L25835NZ10U	662057981864	912400539189	2500lm 80CRI 3500K Narrow Beam 0-10V UNV	Energy Star	1/180	Factory
■ C6L25835WZ10U	662057982205	912400539197	2500lm 80CRI 3500K Wide Beam 0-10V UNV	Energy Star	1/180	Factory
■ C6L25840MZ10U	662057982168	912400539194	2500lm 80CRI 4000K Medium Beam 0-10V UNV	Energy Star	1/180	Factory
■ C6L25840NZ10U	662057981871	912400539190	2500lm 80CRI 4000K Narrow Beam 0-10V UNV	Energy Star	1/180	Factory
■ C6L25840WZ10U	662057982212	912400539198	2500lm 80CRI 4000K Wide Beam 0-10V UNV	Energy Star	1/180	Factory
■ C6L35830MZ10U	662057983448	912400539229	3500lm 80CRI 3000K Medium Beam 0-10V UNV	Energy Star	1/180	Factory
■ C6L35830NZ10U	662057983394	912400539225	3500lm 80CRI 3000K Narrow Beam 0-10V UNV	Energy Star	1/180	Factory
■ C6L35830WZ10U	662057983752	912400539233	3500lm 80CRI 3000K Wide Beam 0-10V UNV	Energy Star	1/180	TN
■ C6L35835MZ10U	662057983455	912400539230	3500lm 80CRI 3500K Medium Beam 0-10V UNV	Energy Star	1/180	Factory
■ C6L35835NZ10U	662057983417	912400539226	3500lm 80CRI 3500K Narrow Beam 0-10V UNV	Energy Star	1/180	Factory
■ C6L35835WZ10U	662057983769	912400539234	3500lm 80CRI 3500K Wide Beam 0-10V UNV	Energy Star	1/180	Factory
■ C6L35840MZ10U	662057983509	912400539231	3500lm 80CRI 4000K Medium Beam 0-10V UNV	Energy Star	1/180	Factory
■ C6L35840NZ10U	662057983424	912400539227	3500lm 80CRI 4000K Narrow Beam 0-10V UNV	Energy Star	1/180	Factory
■ C6L35840WZ10U	662057983790	912400539235	3500lm 80CRI 4000K Wide Beam 0-10V UNV	Energy Star	1/180	TN
■ C6L48830MZ10U	662057999999	912400539277	4800lm 80CRI 3000K Medium Beam 0-10V UNV	Energy Star	1/180	Factory
■ C6L48830NZ10U	662057995861	912400539273	4800lm 80CRI 3000K Narrow Beam 0-10V UNV	Energy Star	1/180	Factory
■ C6L48830WZ10U	190096021741	912400539281	4800lm 80CRI 3000K Wide Beam 0-10V UNV	Energy Star	1/180	Factory
■ C6L48835MZ10U	190096020027	912400539278	4800lm 80CRI 3500K Medium Beam 0-10V UNV	Energy Star	1/180	Factory
■ C6L48835NZ10U	662057995878	912400539274	4800lm 80CRI 3500K Narrow Beam 0-10V UNV	Energy Star	1/180	TN
■ C6L48835WZ10U	190096021758	912400539282	4800lm 80CRI 3500K Wide Beam 0-10V UNV	Energy Star	1/180	Factory
■ C6L48840MZ10U	190096021727	912400539279	4800lm 80CRI 4000K Medium Beam 0-10V UNV	Energy Star	1/180	Factory
■ C6L48840NZ10U	662057995892	912400539275	4800lm 80CRI 4000K Narrow Beam 0-10V UNV	Energy Star	1/180	Factory
■ C6L48840WZ10U	190096021772	912400539283	4800lm 80CRI 4000K Wide Beam 0-10V UNV	Energy Star	1/180	Factory

- Stock Ready (returnable)
- Design Ready (non-returnable)





# Calculite LED

(continued)

Catalog Number	UPC Code	Model Number	Product Description	Compliance	Case/Pallet Qty	Distribution Center
<b>Calculite LED 6" Light Engines (continued)</b>						
■ C6L60830MZ10U	190096021963	912400539302	6000lm 80CRI 3000K Medium Beam 0-10V UNV	Energy Star	1/180	Factory
■ C6L60830NZ10U	190096021925	912400539297	6000lm 80CRI 3000K Narrow Beam 0-10V UNV	Energy Star	1/180	Factory
■ C6L60830WZ10U	190096022007	912400539306	6000lm 80CRI 3000K Wide Beam 0-10V UNV	Energy Star	1/180	Factory
■ C6L60835MZ10U	190096021970	912400539303	6000lm 80CRI 3500K Medium Beam 0-10V UNV	Energy Star	1/180	Factory
■ C6L60835NZ10U	190096021932	912400539298	6000lm 80CRI 3500K Narrow Beam 0-10V UNV	Energy Star	1/180	Factory
■ C6L60835WZ10U	190096022014	912400539307	6000lm 80CRI 3500K Wide Beam 0-10V UNV	Energy Star	1/180	Factory
■ C6L60840MZ10U	190096021987	912400539304	6000lm 80CRI 4000K Medium Beam 0-10V UNV	Energy Star	1/180	Factory
■ C6L60840NZ10U	190096021949	912400539299	6000lm 80CRI 4000K Narrow Beam 0-10V UNV	Energy Star	1/180	Factory
■ C6L60840WZ10U	190096022021	912400539308	6000lm 80CRI 4000K Wide Beam 0-10V UNV	Energy Star	1/180	Factory
<b>Calculite LED 6" Trims</b>						
■ C6RDLCC	662057972862	912400539441	Round Downlight Comfort Clear Finish White Flange	Energy Star	1/96	Factory
■ C6RDLCCF	662057972978	912400539452	Round Downlight Comfort Clear Finish Flangeless	Energy Star	1/96	Factory
■ C6RDLCCP	662057972923	912400539447	Round Downlight Comfort Clear Finish Matching Flange	Energy Star	1/96	Factory
■ C6RDLCD	662057972886	912400539443	Round Downlight Comfort Clear Diffuse Finish White Flange	Energy Star	1/96	Factory
■ C6RDLCDF	662057972992	912400539454	Round Downlight Comfort Clear Diffuse Finish Flangeless	Energy Star	1/96	Factory
■ C6RDLCDP	662057972947	912400539449	Round Downlight Comfort Clear Diffuse Finish Matching Flange	Energy Star	1/96	Factory
■ C6RDLCL	662057972879	912400539442	Round Downlight Specular Clear Finish White Flange	Energy Star	1/96	Factory
■ C6RDLCLF	662057972985	912400539453	Round Downlight Specular Clear Finish Flangeless	Energy Star	1/96	PA
■ C6RDLCLP	662057972930	912400539448	Round Downlight Specular Clear Finish Matching Flange	Energy Star	1/96	Factory
■ C6RDLWH	190096022434	912400539445	Round Downlight White Finish White Flange	Energy Star	1/96	Factory
■ C6RDLWHF	190096022458	912400539456	Round Downlight White Finish Flangeless	Energy Star	1/96	TN
■ C6RWWCC	662057966342	912400539458	Round Wall Wash Comfort Clear Finish White Flange	-	1/96	PA
■ C6RWWCD	662057966366	912400539460	Round Wall Wash Comfort Clear Diffuse Finish White Flange	-	1/96	PA
■ C6RWWWH	190096022465	912400539462	Round Wall Wash White Finish White Flange	-	1/96	PA
■ C6RWWWHF	190096022489	912400539473	Round Wall Wash White Finish Flangeless	-	1/96	Factory
■ C6SDLNMCC	662057971834	912400539733	Square Downlight Narrow/Med. Beam Comfort Clear Finish White Flange	Energy Star	1/96	Factory
■ C6SDLWCC	662057973159	912400539527	Square Downlight Wide Beam Comfort Clear Finish White Flange	Energy Star	1/96	Factory
<b>Calculite LED 6" Accessories</b>						
■ CA6RFT	190096030316	912400538536	Round 6" Mud-in Kit (for flush-mount installations)	-	1/1	CA
■ CA6SFT	190096030323	912400538537	Square 6" Mud-in Kit (for flush-mount installations)	-	1/1	TN
<b>Calculite LED 7" Trims</b>						
■ C7RDLNMCC	662057970745	912400539750	Round Downlight Nar/Med. Beam Comfort Clear Finish White Flange	Energy Star	1/96	Factory
■ C7RDLNMCCP	662057970806	912400539756	Round Downlight Nar/Med. Beam Comfort Clear Finish Matching Flange	Energy Star	1/96	TN
■ C7RDLNMCD	662057970769	912400539752	Round Downlight Nar/Med. Beam Comfort Clear Diffuse Finish White Flange	Energy Star	1/96	TN
■ C7RDLNMCDP	662057970820	912400539758	Round Downlight Nar/Med. Beam Comfort Clear Diffuse Finish Matching Flange	Energy Star	1/96	Factory
■ C7RDLNMCL	662057970752	912400539751	Round Downlight Nar/Med. Beam Specular Clear Finish White Flange	Energy Star	1/96	Factory
■ C7RDLNMWH	190096022755	912400539754	Round Downlight Nar/Med. Beam White Finish White Flange	Energy Star	1/96	Factory
■ C7RDLWCC	662057970912	912400539767	Round Downlight Wide Beam Comfort Clear Finish White Flange	Energy Star	1/96	Factory
■ C7RDLWCD	662057970936	912400539769	Round Downlight Wide Beam Comfort Clear Diffuse Finish White Flange	Energy Star	1/96	Factory
■ C7RDLWCL	662057970929	912400539768	Round Downlight Wide Beam Specular Clear Finish White Flange	Energy Star	1/96	Factory
<b>Calculite LED Accessories</b>						
■ 7994	784197289041	912400460455	Set of 2 Telescoping Mounting Bars-Calculite	-	12/720	PA

- Stock Ready (returnable)
- Design Ready (non-returnable)



# LyteProfile LED



## Flexible

The next generation of Lightolier LyteProfile LED downlights have been redesigned to be flexible for changing project needs.

## Why choose LyteProfile LED?

- 60° cut off ensures proper positioning of optics providing better visual comfort
- The combined light engine and reflector allow tool-free installation using quick connect technology
- Standard 120/277V frame simplifies planning and installation
- Easy troubleshooting, changes and upgrades to products post installation
- Uses the same UniFrame infrastructure as the EasyLyte and Calculite families allowing 50K+ product configurations

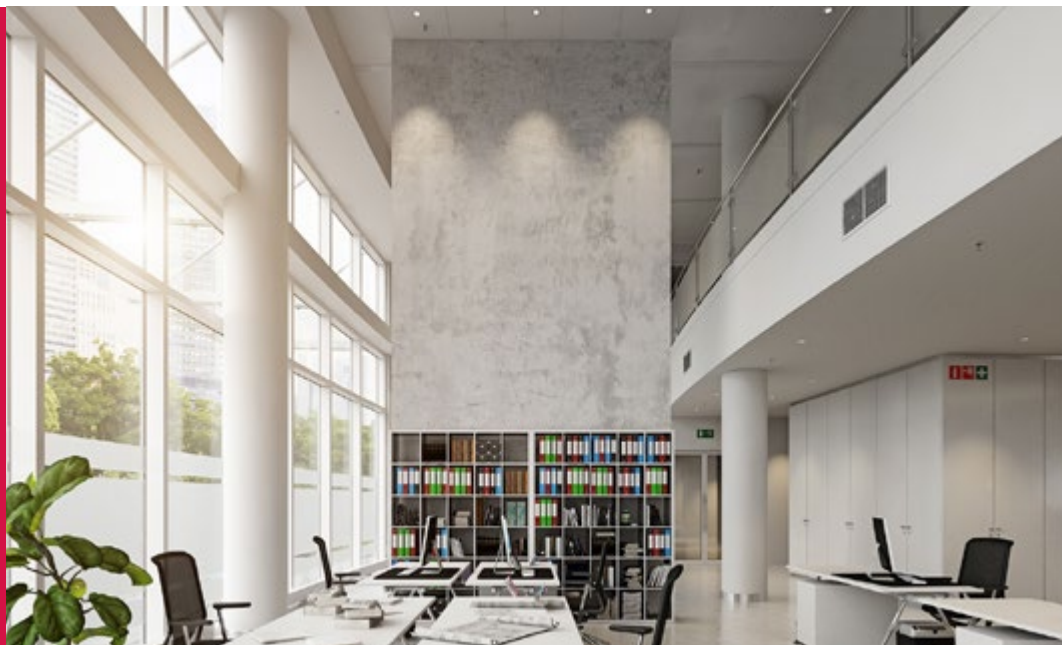

## LyteProfile LED

Catalog Number	UPC Code	Model No.	Product Description	Compliance	Case/Pallet Qty	Dist. Ctr.
<b>LyteProfile LED 3" Round Adjustable Accent Light Engines</b>						
■ P3RA10930NFCCE1	784197687250	912401510623	1000lm 90CRI 3000K Narrow Flood Beam Beam Comfort Clear Finish White Flange ELV 120V	-	1/216	Factory
■ P3RA10930NFCCE1S	784197687267	912401510624	1000lm 90CRI 3000K Narrow Flood Beam Beam Comfort Clear Finish White Flange ELV 120V (Shallow)	-	1/216	Factory
■ P3RA10930NFCPCZ10U	784197690236	912401510506	1000lm 90CRI 3000K Narrow Flood Beam Beam Comfort Clear Finish Matching Flange 0-10V UNV	-	1/216	Factory
■ P3RA10930NFCZ10U	784197687274	912401510625	1000lm 90CRI 3000K Narrow Flood Beam Beam Comfort Clear Finish White Flange 0-10V UNV	-	1/216	Factory
■ P3RA10930NFCZ10US	784197687281	912401510626	1000lm 90CRI 3000K Narrow Flood Beam Beam Comfort Clear Finish White Flange 0-10V UNV (Shallow)	-	1/216	Factory
■ P3RA10930NFCPCZ10U	784197690243	912401510505	1000lm 90CRI 3000K Narrow Flood Beam Beam Comfort Clear Diffuse Finish Matching Flange 0-10V UNV	-	1/216	Factory
■ P3RA10935NFCCE1	784197687298	912401510627	1000lm 90CRI 3500K Narrow Flood Beam Beam Comfort Clear Finish White Flange ELV 120V	-	1/216	Factory
■ P3RA10935NFCCE1S	784197687304	912401510628	1000lm 90CRI 3500K Narrow Flood Beam Beam Comfort Clear Finish White Flange (Shallow)	-	1/216	Factory
■ P3RA10935NFCZ10U	784197687311	912401510629	1000lm 90CRI 3500K Narrow Flood Beam Beam Comfort Clear Finish White Flange 0-10V UNV	-	1/216	Factory
■ P3RA10935NFCZ10US	784197687328	912401510630	1000lm 90CRI 3500K Narrow Flood Beam Beam Comfort Clear Finish White Flange 0-10V UNV (Shallow)	-	1/216	Factory
<b>LyteProfile LED 3" Round Downlight Light Engines</b>						
■ P3RDL10930CCE1	784197687052	912401510631	1000lm 90CRI 3000K Comfort Clear Finish White Flange ELV 120V	Energy Star	1/216	Factory
■ P3RDL10930CCE1S	784197687069	912401510632	1000lm 90CRI 3000K Comfort Clear Finish White Flange ELV 120V (Shallow)	Energy Star	1/216	Factory
■ P3RDL10930CCZ10U	784197666439	912400551373	1000lm 90CRI 3000K Comfort Clear Finish White Flange 0-10V UNV	Energy Star	1/216	Factory
■ P3RDL10935CCE1	784197687076	912401510634	1000lm 90CRI 3500K Comfort Clear Finish White Flange ELV 120V	Energy Star	1/216	Factory
■ P3RDL10935CCE1S	784197687083	912401510635	1000lm 90CRI 3500K Comfort Clear Finish White Flange ELV 120V (Shallow)	Energy Star	1/216	Factory
■ P3RDL10935CCZ10U	784197666446	912400551374	1000lm 90CRI 3500K Comfort Clear Finish White Flange 0-10V UNV	Energy Star	1/216	Factory
■ P3RDL10935WHE1S	784197690052	912401510765	1000lm 90CRI 3500K White Finish White Flange ELV 120V (Shallow)	Energy Star	1/216	Factory
■ P3RDL10935WHZ10U	784197690137	912401510766	1000lm 90CRI 3500K White Finish White Flange 0-10V UNV	Energy Star	1/216	Factory
■ P3RDL109D2WWHZ10U	784197690144	912400551570	1000lm 90CRI 3000K-1800K White Finish White Flange 0-10V UNV	Energy Star	1/216	Factory

- Stock Ready (returnable)
- Design Ready (non-returnable)





# LyteProfile LED

(continued)

Catalog Number	UPC Code	Model No.	Product Description	Compliance	Case/Pallet Qty	Dist. Ctr.
<b>LyteProfile LED 3" Round Downlight Light Engines (continued)</b>						
■ P3RDL15930CCZ10U	784197666477	912400551377	1500lm 90CRI 3000K CCZ White Flange 0-10V UNV	Energy Star	1/216	Factory
■ P3RDL15935CCZ10U	784197666484	912400551378	1500lm 90CRI 3500K CCZ White Flange 0-10V UNV	Energy Star	1/216	Factory
<b>LyteProfile LED 3" Round Lensed Wall Wash Light Engines</b>						
■ P3RLW10930CCE1	784197687090	912401510637	1000lm 90CRI 3000K Comfort Clear Finish White Flange ELV 120V	Energy Star	1/216	Factory
■ P3RLW10930CCE1S	784197687106	912401510638	1000lm 90CRI 3000K Comfort Clear Finish White Flange ELV 120V Shallow	Energy Star	1/216	Factory
■ P3RLW10930CCZ10U	784197666491	912400551379	1000lm 90CRI 3000K Comfort Clear Finish White Flange 0-10V UNV	Energy Star	1/216	Factory
■ P3RLW10935CCE1	784197687113	912401510640	1000lm 90CRI 3500K Comfort Clear Finish White Flange ELV 120V	Energy Star	1/216	Factory
■ P3RLW10935CCE1S	784197687120	912401510641	1000lm 90CRI 3500K Comfort Clear Finish White Flange ELV 120V Shallow	Energy Star	1/216	Factory
■ P3RLW10935CCZ10U	784197666507	912400551380	1000lm 90CRI 3500K Comfort Clear Finish White Flange 0-10V UNV	Energy Star	1/216	Factory
<b>LyteProfile LED 3" Square Adjustable Accent Light Engines</b>						
■ P3SAI0930NFCCE1	784197687335	912401510643	1000lm 90CRI 3000K Narrow Flood Beam Comfort Clear Finish White Flange ELV 120V	Energy Star	1/216	Factory
■ P3SAI0930NFCCE1S	784197687342	912401510644	1000lm 90CRI 3000K Narrow Flood Beam Comfort Clear Finish White Flange ELV 120V Shallow	Energy Star	1/216	Factory
■ P3SAI0935NFCCE1	784197687359	912401510518	1000lm 90CRI 3500K Narrow Flood Beam Comfort Clear Finish White Flange ELV 120V	Energy Star	1/216	Factory
■ P3SAI0935NFCCE1S	784197687366	912401510646	1000lm 90CRI 3500K Narrow Flood Beam Comfort Clear Finish White Flange ELV 120V Shallow	Energy Star	1/216	Factory
<b>LyteProfile LED 3" Square Downlight Light Engines</b>						
■ P3SDL10930CCE1	784197687137	912400551571	1000lm 90CRI 3000K Comfort Clear Finish White Flange ELV 120V	Energy Star	1/216	Factory
■ P3SDL10930CCE1S	784197687144	912401510648	1000lm 90CRI 3000K Comfort Clear Finish White Flange ELV 120V Shallow	Energy Star	1/216	Factory
■ P3SDL10930CCZ10U	784197687151	912401510649	1000lm 90CRI 3000K Comfort Clear Finish White Flange 0-10V UNV	Energy Star	1/216	Factory
■ P3SDL10935CCE1	784197687168	912401510650	1000lm 90CRI 3500K Comfort Clear Finish White Flange ELV 120V	Energy Star	1/216	Factory
■ P3SDL10935CCE1S	784197687175	912401510651	1000lm 90CRI 3500K Comfort Clear Finish White Flange ELV 120V Shallow	Energy Star	1/216	Factory
■ P3SDL10935CCZ10U	784197687182	912401510652	1000lm 90CRI 3500K Comfort Clear Finish White Flange 0-10V UNV	Energy Star	1/216	Factory
<b>LyteProfile LED 3" Square Lensed Wall Wash Light Engines</b>						
■ P3SLW10930CCE1	784197687199	912401510653	1000lm 90CRI 3000K Comfort Clear Finish White Flange ELV 120V	Energy Star	1/216	Factory
■ P3SLW10930CCE1S	784197687205	912401510654	1000lm 90CRI 3000K Comfort Clear Finish White Flange ELV 120V Shallow	Energy Star	1/216	Factory
■ P3SLW10930CCZ10U	784197687212	912401510655	1000lm 90CRI 3000K Comfort Clear Finish White Flange 0-10V UNV	Energy Star	1/216	Factory
■ P3SLW10935CCE1	784197687229	912401510656	1000lm 90CRI 3500K Comfort Clear Finish White Flange ELV 120V	Energy Star	1/216	Factory
■ P3SLW10935CCE1S	784197687236	912401510657	1000lm 90CRI 3500K Comfort Clear Finish White Flange ELV 120V Shallow	Energy Star	1/216	Factory
■ P3SLW10935CCZ10U	784197687243	912400551453	1000lm 90CRI 3500K Comfort Clear Finish White Flange 0-10V UNV	Energy Star	1/216	Factory
<b>LyteProfile LED 4" Round Downlight Light Engines</b>						
● P4RDL10835CCZ10U	190096105441	912400546593	1000lm 80CRI 3500K Wide Beam Comfort Clear Finish White Flange 0-10V UNV	Energy Star	1/96	PA, IL
■ P4RDL15830CCZ10U	190096102600	912400546520	1500lm 80CRI 3000K Wide Beam Comfort Clear Finish White Flange 0-10V UNV	Energy Star	1/96	TN
■ P4RDL15835CCZ10U	190096104406	912400549709	1500lm 80CRI 3500K Wide Beam Comfort Clear Finish White Flange 0-10V UNV	Energy Star	1/96	PA
■ P4RDL15840CDZ10U	190096105595	912400546613	1500lm 80CRI 4000K Wide Beam Clear Diffuse Finish White Flange 0-10V UNV	Energy Star	1/96	Factory
■ P4RDL15840CLZ10U	190096105588	912400546612	1500lm 80CRI 4000K Wide Beam Specular Clear Finish White Flange 0-10V UNV	Energy Star	1/96	Factory
■ P4RDL20830CCZ10U	190096102624	912400546522	2000lm 80CRI 3000K Wide Beam Comfort Clear Finish White Flange 0-10V UNV	Energy Star	1/96	CA, TN, PA
■ P4RDL20830CDZ10U	190096105663	912400546623	2000lm 80CRI 3000K Wide Beam Clear Diffuse Finish White Flange 0-10V UNV	Energy Star	1/96	Factory
■ P4RDL20835CCZ10U	190096102631	912400546523	2000lm 80CRI 3500K Wide Beam Comfort Clear Finish White Flange 0-10V UNV	Energy Star	1/96	PA
■ P4RDL25830CCZ10U	190096105724	912400546630	2500lm 80CRI 3000K Wide Beam Comfort Clear Finish White Flange 0-10V UNV	Energy Star	1/96	TN
■ P4RDL25835CCZ10U	190096105731	912400546631	2500lm 80CRI 3500K Wide Beam Comfort Clear Finish White Flange 0-10V UNV	Energy Star	1/96	TN
<b>LyteProfile LED 4" Round Lensed Wall Wash Light Engines</b>						
■ P4RLW05830CLZ10U	190096112517	912400550797	500lm 80CRI 3000K Wide Beam Specular Clear Finish White Flange 0-10V UNV	-	1/72	Factory
■ P4RLW05835CLZ10U	190096112586	912400550805	500lm 80CRI 3500K Wide Beam Specular Clear Finish White Flange 0-10V UNV	-	1/72	Factory
■ P4RLW05840CLZ10U	190096112654	912400550812	500lm 80CRI 4000K Wide Beam Specular Clear Finish White Flange 0-10V UNV	-	1/72	Factory
■ P4RLW10830CCZ10U	190096113491	912400550824	1000lm 80CRI 3000K Wide Beam Comfort Clear Finish White Flange 0-10V UNV	Energy Star	1/72	Factory
■ P4RLW10830CDZ10U	190096113538	912400550828	1000lm 80CRI 3000K Wide Beam Clear Diffuse Finish White Flange 0-10V UNV	Energy Star	1/72	Factory
■ P4RLW10830CLZ10U	190096113514	912400550826	1000lm 80CRI 3000K Wide Beam Specular Clear Finish White Flange 0-10V UNV	Energy Star	1/72	Factory
■ P4RLW10835CCZ10U	190096113569	912400550831	1000lm 80CRI 3500K Wide Beam Comfort Clear Finish White Flange 0-10V UNV	Energy Star	1/72	Factory
■ P4RLW10835CDZ10U	190096113606	912400550835	1000lm 80CRI 3500K Wide Beam Clear Diffuse Finish White Flange 0-10V UNV	Energy Star	1/72	Factory
■ P4RLW10835CLZ10U	190096113583	912400550833	1000lm 80CRI 3500K Wide Beam Specular Clear Finish White Flange 0-10V UNV	Energy Star	1/72	Factory

- Stock Ready (returnable)
- Design Ready (non-returnable)



# LyteProfile LED

(continued)



Catalog Number	UPC Code	Model No.	Product Description	Compliance	Case/Pallet Qty	Dist. Ctr.
<b>LyteProfile LED 4" Round Lensed Wall Wash Light Engines (continued)</b>						
■ P4RLW10840CCZ10U	190096113637	912400550838	1000lm 80CRI 4000K Wide Beam Comfort Clear Finish White Flange 0-10V UNV	Energy Star	1/72	Factory
■ P4RLW10840CDZ10U	190096113675	912400550842	1000lm 80CRI 4000K Wide Beam Comfort Clear Diffuse Finish White Flange 0-10V UNV	Energy Star	1/72	Factory
■ P4RLW10840CLZ10U	190096113651	912400550840	1000lm 80CRI 4000K Wide Beam Specular Clear Finish White Flange 0-10V UNV	Energy Star	1/72	Factory
■ P4RLW15830CDZ10U	190096113804	912400550855	1500lm 80CRI 3000K Wide Beam Comfort Clear Diffuse Finish White Flange 0-10V UNV	Energy Star	1/72	Factory
■ P4RLW15830CLZ10U	190096113781	912400550853	1500lm 80CRI 3000K Wide Beam Specular Clear Finish White Flange 0-10V UNV	Energy Star	1/72	Factory
■ P4RLW15835CCZ10U	784197681746	912400549320	1500lm 80CRI 3500K Wide Beam Comfort Clear Finish White Flange 0-10V UNV	Energy Star	1/72	TN
■ P4RLW15835CDZ10U	190096114764	912400550860	1500lm 80CRI 3500K Wide Beam Comfort Clear Diffuse Finish White Flange 0-10V UNV	Energy Star	1/72	Factory
■ P4RLW15835CLZ10U	190096114740	912400550858	1500lm 80CRI 3500K Wide Beam Specular Clear Finish White Flange 0-10V UNV	Energy Star	1/72	Factory
■ P4RLW15840CCZ10U	784197681753	912400549321	1500lm 80CRI 4000K Wide Beam Comfort Clear Finish White Flange 0-10V UNV	Energy Star	1/72	Factory
■ P4RLW15840CDZ10U	190096114825	912400550867	1500lm 80CRI 4000K Wide Beam Comfort Clear Diffuse Finish White Flange 0-10V UNV	Energy Star	1/72	Factory
■ P4RLW15840CLZ10U	190096114801	912400550865	1500lm 80CRI 4000K Wide Beam Specular Clear Finish White Flange 0-10V UNV	Energy Star	1/72	Factory
<b>LyteProfile LED 6" Round Downlight Light Engines</b>						
■ P6RDL10830CCZ10U	190096105755	912400546633	1000lm 80CRI 3000K Wide Beam Comfort Clear Finish White Flange 0-10V UNV	Energy Star	1/72	TN
■ P6RDL10840CCZ10U	190096105762	912400546634	1000lm 80CRI 4000K Wide Beam Comfort Clear Finish White Flange 0-10V UNV	Energy Star	1/72	Factory
■ P6RDL10840CDZ10U	190096105779	912400546635	1000lm 80CRI 4000K Wide Beam Comfort Clear Diffuse Finish White Flange 0-10V UNV	Energy Star	1/72	Factory
■ P6RDL15830CCZ10U	190096105816	912400546639	1500lm 80CRI 3000K Wide Beam Comfort Clear Finish White Flange 0-10V UNV	Energy Star	1/72	TN
● P6RDL15835CCZ10U	190096105823	912400546640	1500lm 80CRI 3500K Wide Beam Comfort Clear Finish White Flange 0-10V UNV	Energy Star	1/72	TN, PA, IL
■ P6RDL15840CCZ10U	190096105830	912400546641	1500lm 80CRI 4000K Wide Beam Comfort Clear Finish White Flange 0-10V UNV	Energy Star	1/72	TN
■ P6RDL15840CDZ10U	190096105847	912400546642	1500lm 80CRI 4000K Wide Beam Comfort Clear Diffuse Finish White Flange 0-10V UNV	Energy Star	1/72	Factory
■ P6RDL20830CCZ10U	190096102716	912400546532	2000lm 80CRI 3000K Wide Beam Comfort Clear Finish White Flange 0-10V UNV	Energy Star	1/72	TN
● P6RDL20835CCZ10U	190096105885	912400546647	2000lm 80CRI 3500K Wide Beam Comfort Clear Finish White Flange 0-10V UNV	Energy Star	1/72	PA, IL
● P6RDL20840CCZ10U	190096108817	912400549711	2000lm 80CRI 4000K Wide Beam Comfort Clear Finish White Flange 0-10V UNV	Energy Star	1/72	TN
■ P6RDL25830CCZ10U	190096105892	912400546648	2500lm 80CRI 3000K Wide Beam Comfort Clear Finish White Flange 0-10V UNV	Energy Star	1/72	TN
■ P6RDL25840CCZ10U	190096108831	912400549713	2500lm 80CRI 4000K Wide Beam Comfort Clear Finish White Flange 0-10V UNV	Energy Star	1/72	Factory
■ P6RDL30830CCZ10U	190096105908	912400546649	3000lm 80CRI 3000K Wide Beam Comfort Clear Finish White Flange 0-10V UNV	Energy Star	1/72	Factory
<b>LyteProfile LED 6" Round Lensed Wall Wash Light Engines</b>						
■ P6RLW20830CCZ10U	784197681760	912400549322	2000lm 80CRI 3000K Wide Beam Comfort Clear Finish White Flange 0-10V UNV	Energy Star	1/72	TN
■ P6RLW20835CCZ10U	784197681777	912400549323	2000lm 80CRI 3500K Wide Beam Comfort Clear Finish White Flange 0-10V UNV	Energy Star	1/72	TN
■ P6RLW20840CCZ10U	784197681784	912400549324	2000lm 80CRI 4000K Wide Beam Comfort Clear Finish White Flange 0-10V UNV	Energy Star	1/72	TN
<b>LyteProfile LED 6" Square Downlight Light Engines</b>						
■ P6SDL15835CCZ10U	190096106233	912400547865	1500lm 80CRI 3500K Wide Beam Comfort Clear Finish White Flange 0-10V UNV	Energy Star	1/96	Factory

- Stock Ready (returnable)
- Design Ready (non-returnable)







# UniFrame

Adaptable, so you can be flexible



## Why choose UniFrame?

- Modular plug-and-play receptacle enables quick and easy tool-free installation
- Configurable solutions mean installation can start sooner and be completed in stages
- Future-proof modular design allows easy upgrades without ceiling disturbance
- Unexpected design changes have minimal schedule impact and waste

### UniFrame

Cat.#	UPC Code	Model No.	Product Description	C/P Qty	Dist. Ctr.
<b>2" Round Frames</b>					
● 2RA	190096181865	912401591689	AirSeal IC/CCEA	6/144	Factory
● 2RN	190096181872	912401591690	New Con. Non-IC	4/128	Factory
<b>2" Square Frames</b>					
● 2SA	190096181889	912401591691	AirSeal IC/CCEA	6/144	Factory
● 2SN	190096181896	912401591692	New Con. Non-IC	4/128	Factory
<b>UniFrame 3" Round Frames</b>					
■ 3RA	784197666170	912400551347	Airseal IC	1/1	Factory
■ 3RAS	784197666163	912400551346	Airseal IC Shallow	1/1	Factory
■ 3RN	784197666125	912400551342	New Con. Non-IC	1/96	TN
■ 3RNLC	784197666156	912400551345	New Con. Non-IC Chicago Plen.	1/1	TN
<b>UniFrame 3" Square Frames</b>					
■ 3SA	784197666789	912401510594	Airseal IC	1/1	Factory
■ 3SAS	784197666796	912401510595	Airseal IC Shallow	1/1	Factory
■ 3SN	784197666187	912400551348	New Con. Non-IC	1/96	TN
■ 3SNLC	784197666217	912400551351	New Con. Non-IC Chicago Plen.	1/1	TN

Cat.#	UPC Code	Model No.	Product Description	C/P Qty	Dist. Ctr.
<b>UniFrame 4" Round Frames</b>					
■ 4RA	784197240578	912400540177	AirSeal IC	1/1	Factory
● 4RN	784197641924	912400546884	New Con. Non-IC	1/96	CA, TN, PA, IL, GA*
■ 4RNLC	784197641948	912400546887	New Con. Non-IC Chicago Plen.	1/54	PA
<b>UniFrame 4" Square Frames</b>					
● 4SN	784197641955	912400546890	New Con. Non-IC	1/96	CA, TN, PA, IL
■ 4SNLC	784197690458	912400546893	New Con. Non-IC Chicago Plen.	1/40	TN
<b>UniFrame 6" Round Frames</b>					
■ 6RA	784197240608	912400540173	AirSeal IC	1/1	Factory
● 6RN	784197641979	912400546896	New Con. Non-IC	1/96	CA, TN, PA, IL, GA*
<b>UniFrame 6" Square Frames</b>					
● 6SN	784197642006	912400546903	New Con. Non-IC	1/72	TN
<b>UniFrame 7" Round Frames</b>					
■ 7RN	784197211714	912400546909	New Con. Non-IC	1/72	TN, PA, CA
■ 7RN3	784197211721	912400546910	New Con. Non-IC 347V	1/72	Factory
■ 7RNLC	784197211745	912400546912	New Con. Non-IC Chicago Plen.	1/1	Factory

New Con. = New Construction

- Stock Ready (returnable)
- Design Ready (non-returnable)



# Surface Mount Downlight

## The shallow ceiling **problem solver**

Ideal when you are faced with a challenging ceiling, but you still want a good-looking downlight.

Surface Mount Downlight 7"

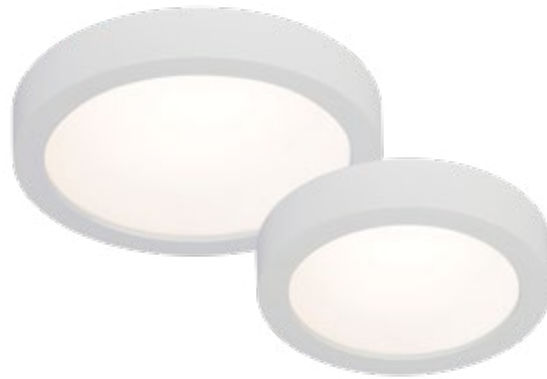

Surface Mount Downlight 5"

## Why choose Surface Mount Downlight?

- Easy to install on standard J-boxes
- Surface mount downlight solves the problem of limited plenum space
- Glare controlling lens for comfortable light distribution
- Affordable alternative to Air-Seal IC recessed housings
- Support wire attached for easy installation
- ENERGY STAR and Title 24 listed



### Surface Mount Downlight

Catalog Number	UPC Code	Model Number	Product Description	Compliance	Case/Pallet Qty	Distribution Center
<b>Surface Mount Downlight 5" Round</b>						
SD5R079301W	190096016426	912400535915	700lm 90 CRI 3000K 120V	Energy Star	20/360	PA
<b>Surface Mount Downlight 7" Round</b>						
SD7R099301W	190096016433	912400535916	1000lm 90 CRI 3000K 120V	Energy Star	20/240	PA

- Stock Ready (returnable)
- Design Ready (non-returnable)



SlimSurface 5" Round



SlimSurface 7" Round

# SlimSurface

Add style and light  
to any space easily

Ideal when you are faced with a challenging ceiling, but you still want a good-looking downlight.



## Why choose SlimSurface?

- Slender 5/8" profile solves the problem of limited plenum space
- Easy to install on standard J-boxes with a quick snap
- Affordable as alternative to Air-Seal IC recessed housings or Fire-Rated boxes
- Wet location listing allows for use in showers and bathrooms (if code requires)
- Even illumination edge-lit technology (flex strip LEDs) will give even illumination with no dark spots or shadows

### SlimSurface

Catalog Number	UPC Code	Model Number	Product Description	Compliance	Case/Pallet Qty	Distribution Center
<b>SlimSurface 4" Square</b>						
■ S4S827K7	662057988788	912401050022	600lm 80CRI 2700K White Finish ELV/TRIAC 120V	Energy Star	1/336	PA
■ S4S827K7AL	662057988795	912401050023	600lm 80CRI 2700K Aluminum Finish ELV/TRIAC 120V	Energy Star	1/336	Factory
■ S4S827K7ALZ10U	662057952406	912401052972	650lm 80CRI 2700K Aluminum Finish 0-10V UNV	Energy Star	-	Factory
■ S4S827K7BK	662057943329	912400537070	600lm 80CRI 2700K Black Finish ELV/TRIAC 120V	Energy Star	-	Factory
■ S4S827K7BKZ10U	662057952413	912401052973	650lm 80CRI 2700K Black Finish 0-10V UNV	Energy Star	-	Factory
■ S4S827K7WZ10U	662057952390	912401052971	650lm 80CRI 2700K White Finish 0-10V UNV	Energy Star	-	Factory
■ S4S830K7	662057988801	912401050024	600lm 80CRI 3000K White Finish ELV/TRIAC 120V	Energy Star	1/336	PA
■ S4S830K7AL	662057988818	912401050025	600lm 80CRI 3000K Aluminum Finish ELV/TRIAC 120V	Energy Star	1/336	Factory
■ S4S830K7ALZ10U	662057952437	912401052975	650lm 80CRI 3000K Aluminum Finish 0-10V UNV	Energy Star	-	Factory
■ S4S830K7BK	662057943350	912400537071	600lm 80CRI 3000K Black Finish ELV/TRIAC 120V	Energy Star	-	Factory
■ S4S830K7BKZ10U	662057952444	912401052976	650lm 80CRI 3000K Black Finish 0-10V UNV	Energy Star	-	Factory
■ S4S830K7WZ10U	662057952420	912401052974	650lm 80CRI 3000K White Finish 0-10V UNV	Energy Star	1/336	Factory
■ S4S835K7AL	662057985459	912400537055	600lm 80CRI 3500K Aluminum Finish ELV/TRIAC 120V	Energy Star	-	Factory
■ S4S835K7ALZ10U	662057952468	912401052978	650lm 80CRI 3500K Aluminum Finish 0-10V UNV	Energy Star	1/336	Factory
■ S4S835K7BK	662057943367	912400537072	600lm 80CRI 3500K Black Finish ELV/TRIAC 120V	Energy Star	-	Factory
■ S4S835K7BKZ10U	662057952475	912401052979	650lm 80CRI 3500K Black Finish 0-10V UNV	Energy Star	-	Factory
■ S4S835K7WZ10U	662057952451	912401052977	650lm 80CRI 3500K White Finish 0-10V UNV	Energy Star	-	Factory
■ S4S840K7AL	662057985473	912400537057	600lm 80CRI 4000K Aluminum Finish ELV/TRIAC 120V	Energy Star	-	Factory
■ S4S840K7ALZ10U	662057952499	912401052981	650lm 80CRI 4000K Aluminum Finish 0-10V UNV	Energy Star	-	Factory
■ S4S840K7BK	662057943381	912400537073	600lm 80CRI 4000K Black Finish ELV/TRIAC 120V	Energy Star	-	Factory

- Stock Ready (returnable)
- Design Ready (non-returnable)



# SlimSurface

(continued)



Catalog Number	UPC Code	Model Number	Product Description	Compliance	Case/Pallet Qty	Distribution Center
<b>SlimSurface 4" Square (continued)</b>						
S4S840K7BKZ10U	662057952505	912401052982	650lm 80CRI 4000K Black Finish 0-10V UNV	Energy Star	-	Factory
S4S840K7WZ10U	662057952482	912401052980	650lm 80CRI 4000K White Finish 0-10V UNV	Energy Star	-	Factory
S4S927K7	662057988825	912401050026	600lm 90CRI 2700K White Finish ELV/TRIAC 120V	Energy Star	1/336	Factory
S4S927K7AL	662057988832	912401050027	600lm 90CRI 2700K Aluminum Finish ELV/TRIAC 120V	Energy Star	1/336	Factory
S4S927K7ALZ10U	662057952529	912401052984	650lm 90CRI 2700K Aluminum Finish 0-10V UNV	Energy Star	-	Factory
S4S927K7BK	662057943527	912400537093	600lm 90CRI 2700K Black Finish ELV/TRIAC 120V	Energy Star	-	Factory
S4S927K7BKZ10U	662057952536	912401052985	650lm 90CRI 2700K Black Finish 0-10V UNV	Energy Star	-	Factory
S4S927K7WZ10U	662057952512	912401052983	650lm 90CRI 2700K White Finish 0-10V UNV	Energy Star	1/336	TN
<b>SlimSurface 5" Round</b>						
S5R827K7	662057988672	912401050011	650lm 80CRI 2700K White Finish ELV/TRIAC 120V	Energy Star	1/336	PA
S5R827K7AL	662057988689	912401050012	600lm 80CRI 2700K Aluminum Finish ELV/TRIAC 120V	Energy Star	1/336	Factory
S5R827K7ALZ10U	662057952550	912401052987	650lm 80CRI 2700K Aluminum Finish 0-10V UNV	Energy Star	-	Factory
S5R827K7BK	662057943398	912400537074	600lm 80CRI 2700K Black Finish ELV/TRIAC 120V	Energy Star	1/336	Factory
S5R827K7BKZ10U	662057952567	912401052988	650lm 80CRI 2700K Black Finish 0-10V UNV	Energy Star	-	Factory
S5R827K7WZ10U	662057952543	912401052986	650lm 80CRI 2700K White Finish 0-10V UNV	Energy Star	1/336	TN
S5R830K7	662057936055	912400530938	650lm 80CRI 3000K White Finish ELV/TRIAC 120V	Energy Star	1/336	CA, TN, PA
S5R830K7AL	662057988696	912401050013	600lm 80CRI 3000K Aluminum Finish ELV/TRIAC 120V	Energy Star	1/336	Factory
S5R830K7ALZ10U	662057952581	912401052990	650lm 80CRI 3000K Aluminum Finish 0-10V UNV	Energy Star	-	Factory
S5R830K7BK	662057943404	912400537075	600lm 80CRI 3000K Black Finish ELV/TRIAC 120V	Energy Star	-	Factory
S5R830K7BKZ10U	662057952598	912401052991	650lm 80CRI 3000K Black Finish 0-10V UNV	Energy Star	-	Factory
S5R830K7WZ10U	662057952574	912401052989	650lm 80CRI 3000K White Finish 0-10V UNV	Energy Star	1/336	Factory
S5R835K7AL	662057985497	912400537059	600lm 80CRI 3500K Aluminum Finish ELV/TRIAC 120V	Energy Star	-	Factory
S5R835K7ALZ10U	662057952611	912401052993	650lm 80CRI 3500K Aluminum Finish 0-10V UNV	Energy Star	1/336	Factory
S5R835K7BK	662057943411	912400537076	600lm 80CRI 3500K Black Finish ELV/TRIAC 120V	Energy Star	1/336	TN
S5R835K7BKZ10U	662057952628	912401052994	650lm 80CRI 3500K Black Finish 0-10V UNV	Energy Star	-	Factory
S5R835K7WZ10U	662057952604	912401052992	650lm 80CRI 3500K White Finish 0-10V UNV	Energy Star	1/336	TN
S5R840K7AL	662057985527	912400537061	600lm 80CRI 4000K Aluminum Finish ELV/TRIAC 120V	Energy Star	-	Factory
S5R840K7ALZ10U	662057952642	912401052996	650lm 80CRI 4000K Aluminum Finish 0-10V UNV	Energy Star	-	Factory
S5R840K7BK	662057943428	912400537077	600lm 80CRI 4000K Black Finish ELV/TRIAC 120V	Energy Star	-	Factory
S5R840K7BKZ10U	662057952659	912401052997	650lm 80CRI 4000K Black Finish 0-10V UNV	Energy Star	1/336	TN
S5R840K7WZ10U	662057952635	912401052995	650lm 80CRI 4000K White Finish 0-10V UNV	Energy Star	-	Factory
S5R927K7	662057988702	912401050014	600lm 90CRI 2700K White Finish ELV/TRIAC 120V	Energy Star	1/336	Factory
S5R927K7AL	662057988719	912401050015	600lm 90CRI 2700K Aluminum Finish ELV/TRIAC 120V	Energy Star	1/336	Factory
S5R927K7ALZ10U	662057952673	912401052999	650lm 90CRI 2700K Aluminum Finish 0-10V UNV	Energy Star	-	Factory
S5R927K7BK	662057943534	912400537094	600lm 90CRI 2700K Black Finish ELV/TRIAC 120V	Energy Star	-	Factory
S5R927K7BKZ10U	662057952680	912401053001	650lm 90CRI 2700K Black Finish 0-10V UNV	Energy Star	-	Factory
S5R927K7WZ10U	662057952666	912401052998	650lm 90CRI 2700K White Finish 0-10V UNV	Energy Star	1/336	TN
S5R930K7	190096037056	912400542343	600lm 90CRI 3000K White Finish ELV/TRIAC 120V	Energy Star	1/336	TN
<b>SlimSurface 6" Square</b>						
S6S827K10	662057988849	912401050028	900lm 80CRI 2700K White Finish ELV/TRIAC 120V	Energy Star	1/160	Factory
S6S827K10AL	662057988856	912401050029	900lm 80CRI 2700K Aluminum Finish ELV/TRIAC 120V	Energy Star	1/160	Factory
S6S827K10ALZ10U	662057952703	912401053003	900lm 80CRI 2700K Aluminum Finish 0-10V UNV	Energy Star	-	Factory
S6S827K10BK	662057943435	912400537078	900lm 80CRI 2700K Black Finish ELV/TRIAC 120V	Energy Star	-	Factory
S6S827K10BKZ10U	662057952710	912401053004	900lm 80CRI 2700K Black Finish 0-10V UNV	Energy Star	-	Factory
S6S827K10WZ10U	662057952697	912401053002	900lm 80CRI 2700K White Finish 0-10V UNV	Energy Star	1/160	Factory
S6S830K10	662057988863	912401050030	900lm 80CRI 3000K White Finish ELV/TRIAC 120V	Energy Star	1/160	Factory
S6S830K10AL	662057988870	912401050031	900lm 80CRI 3000K Aluminum Finish ELV/TRIAC 120V	Energy Star	1/160	PA
S6S830K10ALZ10U	662057952734	912401053006	900lm 80CRI 3000K Aluminum Finish 0-10V UNV	Energy Star	1/160	TN
S6S830K10BK	662057943442	912400537079	900lm 80CRI 3000K Black Finish ELV/TRIAC 120V	Energy Star	-	Factory
S6S830K10BKZ10U	662057952741	912401053007	900lm 80CRI 3000K Black Finish 0-10V UNV	Energy Star	-	Factory
S6S830K10WZ10U	662057952727	912401053005	900lm 80CRI 3000K White Finish 0-10V UNV	Energy Star	-	Factory
S6S835K10	662057985534	912400537062	900lm 80CRI 3500K White Finish ELV/TRIAC 120V	Energy Star	1/160	Factory
S6S835K10AL	662057985541	912400537063	900lm 80CRI 3500K Aluminum Finish ELV/TRIAC 120V	Energy Star	-	Factory
S6S835K10ALZ10U	662057952765	912401053009	900lm 80CRI 3500K Aluminum Finish 0-10V UNV	Energy Star	-	Factory

- Stock Ready (returnable)
- Design Ready (non-returnable)



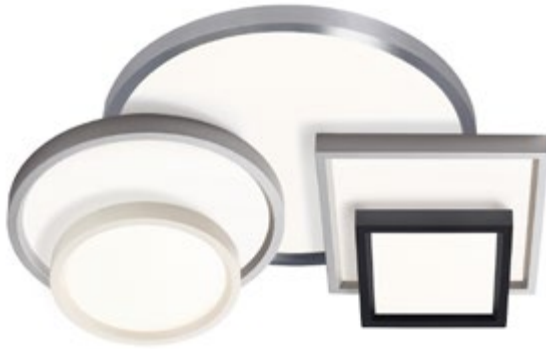

# SlimSurface

(continued)

Catalog Number	UPC Code	Model Number	Product Description	Compliance	Case/Pallet Qty	Distribution Center
<b>SlimSurface 6" Square (continued)</b>						
■ S6S835K10BK	662057943459	912400537080	900lm 80CRI 3500K Black Finish ELV/TRIAC 120V	Energy Star	-	Factory
■ S6S835K10BKZ10U	662057952772	912401053010	900lm 80CRI 3500K Black Finish 0-10V UNV	Energy Star	-	Factory
■ S6S835K10WZ10U	662057952758	912401053008	900lm 80CRI 3500K White Finish 0-10V UNV	Energy Star	1/160	Factory
■ S6S840K10	662057985558	912400537064	900lm 80CRI 4000K White Finish ELV/TRIAC 120V	Energy Star	1/160	Factory
■ S6S840K10AL	662057985565	912400537065	900lm 80CRI 4000K Aluminum Finish ELV/TRIAC 120V	Energy Star	1/160	TN
■ S6S840K10ALZ10U	662057952796	912401053012	900lm 80CRI 4000K Aluminum Finish 0-10V UNV	Energy Star	-	Factory
■ S6S840K10BK	662057943466	912400537081	900lm 80CRI 4000K Black Finish ELV/TRIAC 120V	Energy Star	-	Factory
■ S6S840K10BKZ10U	662057952802	912401053013	900lm 80CRI 4000K Black Finish 0-10V UNV	Energy Star	-	Factory
■ S6S840K10WZ10U	662057952789	912401053011	900lm 80CRI 4000K White Finish 0-10V UNV	Energy Star	-	Factory
■ S6S927K10AL	662057988894	912401050033	900lm 90CRI 2700K Aluminum Finish ELV/TRIAC 120V	Energy Star	1/160	Factory
■ S6S927K10ALZ10U	662057952826	912401053015	900lm 90CRI 2700K Aluminum Finish 0-10V UNV	Energy Star	-	Factory
■ S6S927K10BK	662057943541	912400537095	900lm 90CRI 2700K Black Finish ELV/TRIAC 120V	Energy Star	-	Factory
■ S6S927K10BKZ10U	662057952833	912401053016	900lm 90CRI 2700K Black Finish 0-10V UNV	Energy Star	-	Factory
■ S6S927K10WZ10U	662057952819	912401053014	900lm 90CRI 2700K White Finish 0-10V UNV	Energy Star	1/160	Factory
<b>SlimSurface 7" Round</b>						
● S7R827K10	662057988726	912401050016	1000lm 80CRI 2700K White Finish ELV/TRIAC 120V	Energy Star	1/160	TN, PA
■ S7R827K10AL	662057988733	912401050017	900lm 80CRI 2700K Aluminum Finish ELV/TRIAC 120V	Energy Star	1/160	PA
■ S7R827K10ALZ10U	662057952857	912401053018	900lm 80CRI 2700K Aluminum Finish 0-10V UNV	Energy Star	-	Factory
■ S7R827K10BK	662057943473	912400537082	900lm 80CRI 2700K Black Finish ELV/TRIAC 120V	Energy Star	-	Factory
■ S7R827K10BKZ10U	662057952864	912401053019	900lm 80CRI 2700K Black Finish 0-10V UNV	Energy Star	-	Factory
■ S7R827K10WZ10U	662057952840	912401053017	900lm 80CRI 2700K White Finish 0-10V UNV	Energy Star	-	Factory
● S7R830K10	662057988740	912401050018	1000lm 80CRI 3000K White Finish ELV/TRIAC 120V	Energy Star	1/160	CA, TN, PA
■ S7R830K10ALZ10U	662057952888	912401053021	900lm 80CRI 3000K Aluminum Finish 0-10V UNV	Energy Star	-	Factory
■ S7R830K10BK	662057980027	912400537083	900lm 80CRI 3000K Black Finish ELV/TRIAC 120V	Energy Star	1/160	Factory
■ S7R830K10BKZ10U	662057952895	912401053022	900lm 80CRI 3000K Black Finish 0-10V UNV	Energy Star	-	Factory
■ S7R830K10WZ10U	662057952871	912401053020	900lm 80CRI 3000K White Finish 0-10V UNV	Energy Star	1/160	Factory
● S7R835K10	662057985572	912400537066	900lm 80CRI 3500K White Finish ELV/TRIAC 120V	Energy Star	1/160	TN, PA
■ S7R835K10AL	662057985589	912400537067	900lm 80CRI 3500K Aluminum Finish ELV/TRIAC 120V	Energy Star	1/160	Factory
■ S7R835K10ALZ10U	662057952918	912401053024	900lm 80CRI 3500K Aluminum Finish 0-10V UNV	Energy Star	-	Factory
■ S7R835K10BK	662057943480	912400537084	900lm 80CRI 3500K Black Finish ELV/TRIAC 120V	Energy Star	1/160	Factory
■ S7R835K10BKZ10U	662057952925	912401053025	900lm 80CRI 3500K Black Finish 0-10V UNV	Energy Star	-	Factory
■ S7R835K10WZ10U	662057952901	912401053023	900lm 80CRI 3500K White Finish 0-10V UNV	Energy Star	1/160	Factory
■ S7R840K10AL	662057985602	912400537069	900lm 80CRI 4000K Aluminum Finish ELV/TRIAC 120V	Energy Star	1/160	TN
■ S7R840K10ALZ10U	662057952949	912401053027	900lm 80CRI 4000K Aluminum Finish 0-10V UNV	Energy Star	1/160	Factory
■ S7R840K10BK	662057943497	912400537085	900lm 80CRI 4000K Black Finish ELV/TRIAC 120V	Energy Star	-	Factory
■ S7R840K10BKZ10U	662057952956	912401053028	900lm 80CRI 4000K Black Finish 0-10V UNV	Energy Star	1/160	TN
■ S7R840K10WZ10U	662057952932	912401053026	900lm 80CRI 4000K White Finish 0-10V UNV	Energy Star	1/160	Factory
■ S7R927K10	662057988764	912401050020	900lm 90CRI 2700K White Finish ELV/TRIAC 120V	Energy Star	1/160	Factory
■ S7R927K10AL	662057988771	912401050021	900lm 90CRI 2700K Aluminum Finish ELV/TRIAC 120V	Energy Star	1/160	Factory
■ S7R927K10ALZ10U	662057952970	912401053030	900lm 90CRI 2700K Aluminum Finish 0-10V UNV	Energy Star	-	Factory
■ S7R927K10BK	662057943558	912400537096	900lm 90CRI 2700K Black Finish ELV/TRIAC 120V	Energy Star	1/160	TN
■ S7R927K10BKZ10U	662057952987	912401053031	900lm 90CRI 2700K Black Finish 0-10V UNV	Energy Star	-	Factory
■ S7R927K10WZ10U	662057952963	912401053029	900lm 90CRI 2700K White Finish 0-10V UNV	Energy Star	1/160	TN
● S7R930K10	190096037179	912400542349	900lm 90CRI 3000K White Finish ELV/TRIAC 120V	Energy Star	1/160	PA
<b>SlimSurface 10" Round</b>						
■ S10R827K22W	190096087365	912400542311	2200lm 80CRI 2700K White Finish ELV/TRIAC 120V	Energy Star	1/120	TN
■ S10R827K22WZ10U	190096063956	912400542315	2200lm 80CRI 2700K White Finish 0-10V UNV	Energy Star	1/120	TN
■ S10R830K22WZ10U	190096063963	912400542323	2200lm 80CRI 3000K White Finish 0-10V UNV	Energy Star	1/120	Factory
■ S10R835K22WZ10U	190096063970	912400542331	2200lm 80CRI 3500K White Finish 0-10V UNV	Energy Star	1/120	Factory
■ S10R927K22W	190096087402	912400542294	2200lm 90CRI 2700K White Finish ELV/TRIAC 120V	Energy Star	1/120	Factory
■ S10R927K22WZ10U	190096063932	912400542298	2200lm 90CRI 2700K White Finish 0-10V UNV	Energy Star	1/120	Factory
■ S10R930K22W	190096087419	912400542303	2200lm 90CRI 3000K White Finish ELV/TRIAC 120V	Energy Star	1/120	Factory
■ S10R930K22WZ10U	190096063949	912400542307	2200lm 90CRI 3000K White Finish 0-10V UNV	Energy Star	1/120	Factory

● Stock Ready (returnable)  
 ■ Design Ready (non-returnable)



# Commercial Retrofit Downlight



Bright, brighter, brightest... **it's your choice**

Will reduce onsite time and headaches for busy installers with its adjustable lumen and color output switch

## Why choose Commercial Retrofit Downlight?

- Adjustable lumen output and color temperature switch allows you to make choices while you install or afterward
- Great for different ceiling heights and different light level needs
- Sturdy metal clips provide a solid fit and easy installation
- Out-of-the-box pre-wired with flexible metal conduit
- 50,000 hour rated life (L70)



## Commercial Retrofit Downlight

Catalog Number	UPC Code	Model Number	Product Description	Compliance	Case/Pallet Qty	Distribution Center
<b>Commercial Retrofit Downlight (DualSelect) Selectable CCT 4" Round</b>						
CR4RLMCCT	190096131266	911401870081	500-1000lm 90CRI 3000K-3500K-4000K White Finish 120-347V	-	-	CA, TN, PA
<b>Commercial Retrofit Downlight (DualSelect) Selectable CCT 6" Round</b>						
CR6RLMCCT	190096131273	911401870181	700-1500lm 90CRI 3000K-3500K-4000K White Finish 120-347V	-	-	CA, TN, PA
<b>Commercial Retrofit Downlight (DualSelect) Selectable CCT 8" Round</b>						
CR8RLMCCT	190096131280	911401870281	1000-2000lm 90CRI 3000K-3500K-4000K White Finish 120-347V	-	-	CA, TN, PA
<b>Commercial Retrofit Downlight (DualSelect) Selectable CCT 10" Round</b>						
CR10RLMCCT	190096131297	911401870381	2000-3000lm 90CRI 3000K-3500K-4000K White Finish 120-347V	-	-	CA, TN, PA

- Stock Ready (returnable)
- Design Ready (non-returnable)



Retrofit Downlight 4"



Retrofit Downlight 5/6"

# Retrofit Downlight

An LED retrofit as **easy as snap and click**

Hassle-free install will save you time and frustration on the job site. You may not even need to open your toolbox.



## Why choose Retrofit Downlight?

- Utilizes existing frames to make replacing old downlighting and upgrading to LED a truly easy task
- Flexible springs allow for installation without tools
- Quick-connect plug and medium-based socket adapter means no extra accessories to purchase
- Contemporary and discreet, white baffle trim design
- Uniform LED light with glare-reduction filter, means a more comfortable space

## Retrofit Downlight

Catalog Number	UPC Code	Model Number	Product Description	Compliance	Case/Pallet Qty	Distribution Center
<b>Retrofit Downlight 4" Round</b>						
RD4R089301W	190096016389	912400535911	900lm 90CRI 3000K 120V	Energy Star	12/336	PA
<b>Retrofit Downlight 5/6" Round</b>						
RD5R129301W	190096016396	912400535912	1400lm 90CRI 3000K 120V	Energy Star	12/144	TN

- Stock Ready (returnable)
- Design Ready (non-returnable)



# LyteCaster LED

## Comfort and quality

Lightolier LyteCaster LED Downlight and Adjustable luminaires provide comfortable, quality illumination for new construction and renovation spaces.



## Why choose LyteCaster LED?

- Comprehensive low cost IC family provides great value and visual performance
- 4", 5" and 6" round and square
- Efficacy up to 90lm/W
- Lumens: 650-2000



### LyteCaster LED

Catalog Number	UPC Code	Model Number	Product Description	Compliance	Case/Pallet Qty	Distribution Center
<b>LyteCaster LED 4" Round Frames</b>						
● L4RAE1VA	662057941639	912401052568	650lm AirSeal IC New Construction with Screws ELV 120V	-	1/90	PA
■ L4RANE1VA	662057941653	912401052569	650lm AirSeal IC New Construction with Nails ELV 120V	Energy Star	1/88	Factory
● L4RAZ10UVA	662057941646	912401052571	650lm AirSeal IC New Construction with Screws 0-10V UNV	Energy Star	1/90	PA
■ L4RANZ10UVA	662057941769	912401052570	650lm AirSeal IC New Construction with Nails 0-10V UNV	-	1/90	Factory
● L4R10AE1VA	190096019526	912401052854	1000lm AirSeal IC New Construction with Screws ELV 120V	-	1/90	TN, PA
● L4R10ANE1VA	662057952079	912401052855	1000lm AirSeal IC New Construction with Nails ELV 120V	Energy Star	1/88	TN
● L4R10AZ10UVA	190096019533	912401052857	1000lm AirSeal IC New Construction with Screws 0-10V UNV	Energy Star	1/90	CA, PA
■ L4R10ANZ10UVA	662057952062	912401052856	1000lm AirSeal IC New Construction with Nails 0-10V UNV	Energy Star	1/88	CA
■ L4R10RE1VA	190096019601	912401053524	1000lm AirSeal IC Remodeler ELV 120V	Energy Star	1/224	PA
<b>LyteCaster LED 4" Round Adjustable Accent Light Engines / Trims</b>						
■ L4RA06830WVA	662057941059	912401052564	650lm 80CRI 3000K White Finish	Energy Star	1/336	CA
■ L4RA06840WVA	662057941073	912401052566	650lm 80CRI 4000K White Finish	Energy Star	-	Factory
■ L4RA10827WVA	662057951904	912401052876	1000lm 80CRI 2700K White Finish	Energy Star	1/336	TN
■ L4RA10830WVA	662057951911	912401052877	1000lm 80CRI 3000K White Finish	Energy Star	-	Factory
■ L4RA10835WVA	662057951928	912401052878	1000lm 80CRI 3500K White Finish	Energy Star	-	Factory
■ L4RA10840WVA	662057951935	912401052879	1000lm 80CRI 4000K White Finish	Energy Star	-	Factory
■ L4RA10927WVA	662057951942	912401052880	1000lm 90CRI 2700K White Finish	Energy Star	1/336	TN
<b>LyteCaster LED 4" Round Downlight Light Engines</b>						
■ L4R06827VA	662057998718	912401052558	650lm 80CRI 2700K	Energy Star	1/336	CA
● L4R06830VA	662057998725	912401052559	650lm 80CRI 3000K	-	1/336	PA

- Stock Ready (returnable)
- Design Ready (non-returnable)







# LyteCaster LED

(continued)

Catalog Number	UPC Code	Model Number	Product Description	Compliance	Case/Pallet Qty	Distribution Center
<b>LyteCaster LED 4" Round Downlight Light Engines (continued)</b>						
■ L4R06835VA	662057998749	912401052560	650lm 80CRI 3500K	Energy Star	1/336	Factory
■ L4R06840VA	662057999388	912401052561	650lm 80CRI 4000K	Energy Star	-	Factory
● L4R10827VA	662057950877	912401052849	1000lm 80CRI 2700K	Energy Star	1/336	PA
● L4R10830VA	190096019519	912401052850	1000lm 80CRI 3000K	Energy Star	1/336	TN, PA
■ L4R10835VA	662057950891	912401052851	1000lm 80CRI 3500K	Energy Star	1/336	Factory
■ L4R10840VA	662057950907	912401052852	1000lm 80CRI 4000K	Energy Star	-	Factory
■ L4R10927VA	662057950914	912401052853	1000lm 90CRI 2700K	Energy Star	-	Factory
<b>LyteCaster LED 4" Round Downlight Trims</b>						
● L4RBW	662057993690	912401050056	Baffle Downlight Style White Finish	-	1/378	PA
■ L4RDD	662057993706	912401050057	Open Downlight Style Clear Diffuse Finish	Energy Star	1/378	Factory
■ L4RDW	662057993713	912401050058	Open Downlight Style White Finish	Energy Star	1/378	Factory
<b>LyteCaster LED 4" Square Downlight Trims</b>						
■ L4SBW	190096031429	912400536326	Baffle Downlight Style White Finish	Energy Star	1/378	Factory
■ L4SDD	190096031399	912400536323	Open Downlight Style Clear Diffuse Finish	Energy Star	1/378	Factory
<b>LyteCaster LED 5" Round Frames</b>						
● L5RAE1VA	662057941684	912401052582	1000lm AirSeal IC New Construction with Screws ELV 120V	-	1/90	PA
■ L5RANE1VA	662057941707	912401052583	1000lm AirSeal IC New Construction with Nails ELV 120V	Energy Star	1/88	CA
● L5RAZ10UVA	662057941691	912401052585	1000lm AirSeal IC New Construction with Screws 0-10V UNV	Energy Star	1/90	PA
■ L5RANZ10UVA	662057941714	912401052584	1000lm AirSeal IC New Construction with Nails ELV 120V	Energy Star	1/88	TN
● L5R10RE1VA	190096019564	912401053526	1000lm AirSeal IC Remodeler ELV 120V	Energy Star	1/192	PA
■ L5R15AE1VA	662057952093	912401052863	1500lm AirSeal IC New Construction with Screws ELV 120V	-	1/88	PA
■ L5R15AZ10UVA	662057952123	912401052866	1500lm AirSeal IC New Construction with Screws 0-10V 120V	Energy Star	1/88	TN
■ L5R15ANZ10UVA	662057952109	912401052865	1500lm AirSeal IC New Construction with Nails 0-10V UNV	Energy Star	1/88	Factory
<b>LyteCaster LED 5" Round Adjustable Accent Light Engines / Trims</b>						
■ L5RA10830WVA	662057941158	912401052578	1000lm 80CRI 3000K White Finish	Energy Star	1/294	CA
■ L5RA10835WVA	662057941165	912401052579	1000lm 80CRI 3500K White Finish	Energy Star	-	Factory
■ L5RA10840WVA	662057941172	912401052580	1000lm 80CRI 4000K White Finish	Energy Star	-	Factory
■ L5RA10927WVA	662057941189	912401052581	1000lm 90CRI 2700K White Finish	Energy Star	-	CA
■ L5RA15827WVA	662057951959	912401052881	1500lm 80CRI 2700K White Finish	Energy Star	1/294	TN
■ L5RA15830WVA	662057951966	912401052882	1500lm 80CRI 3000K White Finish	Energy Star	-	Factory
■ L5RA15835WVA	662057951973	912401052883	1500lm 80CRI 3500K White Finish	Energy Star	-	Factory
■ L5RA15840WVA	662057951980	912401052884	1500lm 80CRI 4000K White Finish	Energy Star	-	Factory
■ L5RA15927WVA	662057951997	912401052885	1500lm 90CRI 2700K White Finish	Energy Star	-	Factory
<b>LyteCaster LED 5" Round Downlight Light Engines</b>						
■ L5R10827VA	662057941097	912401052572	1000lm 80CRI 2700K	Energy Star	-	Factory
● L5R10830VA	662057941103	912401052573	1000lm 80CRI 3000K	-	1/336	TN
● L5R10835VA	662057941110	912401052574	1000lm 80CRI 3500K	Energy Star	1/336	PA
■ L5R10840VA	662057941127	912401052575	1000lm 80CRI 4000K	Energy Star	-	Factory
● L5R10927VA	662057941134	912401052576	1000lm 90CRI 2700K	-	-	CA
■ L5R15827VA	662057950921	912401052858	1500lm 80CRI 2700K	Energy Star	-	Factory
● L5R15830VA	662057950938	912401052859	1500lm 80CRI 3000K	-	1/336	TN
■ L5R15835VA	662057950945	912401052860	1500lm 80CRI 3500K	Energy Star	1/336	PA
■ L5R15840VA	662057950952	912401052861	1500lm 80CRI 4000K	Energy Star	-	Factory
■ L5R15927VA	662057950969	912401052862	1500lm 90CRI 2700K	Energy Star	1/336	Factory
<b>LyteCaster LED 5" Round Downlight Trims</b>						
● L5RBW	662057993836	912401050072	Baffle Downlight Style White Finish	-	1/378	PA
● L5RDD	662057993843	912401050073	Open Downlight Style Clear Diffuse Finish	-	1/378	TN, PA
■ L5RDW	662057993850	912401050074	Open Downlight Style White Finish	Energy Star	1/378	Factory

● Stock Ready (returnable)  
■ Design Ready (non-returnable)



# LyteCaster LED

(continued)



Catalog Number	UPC Code	Model Number	Product Description	Compliance	Case/Pallet Qty	Distribution Center
<b>LyteCaster LED 5" Square Downlight Trims</b>						
L5SBW	190096031436	912400536327	Baffle Downlight Style White Finish	Energy Star	1/160	PA
L5SDD	190096031405	912400536324	Open Downlight Style Clear Diffuse Finish	Energy Star	1/160	PA
L5SDW	190096031375	912400536321	Open Downlight Style White Finish	Energy Star	1/160	Factory
<b>LyteCaster LED 6" Round Frames</b>						
L6RAE1VA	662057994062	912401052596	1500lm AirSeal IC New Construction with Screws ELV 120V	-	1/90	PA
L6RANE1VA	662057994079	912401052597	1500lm AirSeal IC New Construction with Nails ELV 120V	-	1/90	TN
L6RAZ10UVA	662057999708	912401052599	1500lm AirSeal IC New Construction with Screws 0-10V UNV	-	1/90	CA, TN, PA
L6RANZ10UVA	662057999715	912401052598	1500lm AirSeal IC New Construction with Nails 0-10V UNV	-	1/90	PA
L6R20AE1VA	662057952130	912401052872	2000lm AirSeal IC New Construction with Screws ELV 120V	Energy Star	1/88	PA
L6R20AZ10UVA	662057952161	912401052875	2000lm AirSeal IC New Construction with Screws 0-10V UNV	Energy Star	1/88	CA, TN, PA
L6R20ANZ10UVA	662057952147	912401052874	2000lm AirSeal IC New Construction with Nails 0-10V UNV	Energy Star	1/88	TN
<b>LyteCaster LED 6" Round Adjustable Accent Light Engines / Trims</b>						
L6RA15830WVA	662057941257	912401052592	1500lm 80CRI 3000K White Finish	Energy Star	-	CA
L6RA15840WVA	662057941271	912401052594	1500lm 80CRI 4000K White Finish	Energy Star	1/160	PA
L6RA15927WVA	662057941288	912401052595	1500lm 90CRI 2700K White Finish	Energy Star	1/160	CA
L6RA20827WVA	662057952000	912401052886	2000lm 80CRI 2700K White Finish	Energy Star	-	Factory
L6RA20830WVA	662057952017	912401052887	2000lm 80CRI 3000K White Finish	Energy Star	-	Factory
L6RA20835WVA	662057952024	912401052888	2000lm 80CRI 3500K White Finish	Energy Star	-	Factory
L6RA20840WVA	662057952031	912401052889	2000lm 80CRI 4000K White Finish	Energy Star	-	Factory
L6RA20927WVA	662057952048	912401052890	2000lm 90CRI 2700K White Finish	Energy Star	-	Factory
<b>LyteCaster LED 6" Round Downlight Light Engines</b>						
L6R15827VA	662057941196	912401052586	1500lm 80CRI 2700K	-	-	CA
L6R15830VA	662057941202	912401052587	1500lm 80CRI 3000K	-	1/378	TN
L6R15835VA	662057941219	912401052588	1500lm 80CRI 3500K	Energy Star	1/378	Factory
L6R15840VA	662057941226	912401052589	1500lm 80CRI 4000K	Energy Star	1/378	TN
L6R15927VA	662057941233	912401052590	1500lm 90CRI 2700K	-	1/378	Factory
L6R20827VA	662057950976	912401052867	2000lm 80CRI 2700K	Energy Star	-	Factory
L6R20830VA	662057950983	912401052868	2000lm 80CRI 3000K	Energy Star	1/378	PA
L6R20835VA	662057950990	912401052869	2000lm 80CRI 3500K	Energy Star	1/378	TN, PA
L6R20840VA	662057951003	912401052870	2000lm 80CRI 4000K	Energy Star	-	Factory
L6R20927VA	662057951010	912401052871	2000lm 90CRI 2700K	Energy Star	-	Factory
<b>LyteCaster LED 6" Round Downlight Trims</b>						
L6RBW	662057993980	912401050085	Baffle Downlight Style White Finish	-	1/160	PA
L6RDD	662057993997	912401050086	Open Downlight Style Clear Diffuse Finish	-	1/160	CA, TN, PA
L6RDW	662057994000	912401050087	Open Downlight Style White Finish	-	1/160	PA
<b>LyteCaster LED 6" Square Downlight Trims</b>						
L6SBW	190096031443	912400536328	Baffle Downlight Style White Finish	Energy Star	1/160	PA
L6SDD	190096031412	912400536325	Open Downlight Style Clear Diffuse Finish	Energy Star	1/160	PA
<b>LyteCaster AirSeal Gasket</b>						
LAS56	784197367237	912400461497	AirSeal Gasket	-	120/1200	PA

- Stock Ready (returnable)
- Design Ready (non-returnable)





# LyteCaster LED Accent

Design versatility to fit any space

A wide range of options to customize your lighting solution for any application with efficacies ranging up to 800 lm/W.



## Why choose LyteCaster LED Accent?

- Sizes: 3"
- Efficacy: up to 72 lm/W
- Lumens: 800
- Wattage: 11 W
- Voltage: 120V or 120V-277V
- CCT: 2700 K-3500 K
- CRI: 80 min
- Dimming: ELV/TRIAC (10%)
- Lifetime: 50,000 hour (L70)

### LyteCaster LED Accent

Catalog Number	UPC Code	Model Number	Product Description	Compliance	Case/Pallet Qty	Distribution Center
<b>LyteCaster LED 3" Round Frames</b>						
● L3AE1	662057999326	912401052144	AirSeal IC New Construction with Screws ELV 120V	-	1/90	CA, TN, PA
■ L3AHB	662057997889	912401052149	3.75" ACCESSORY HOLDER BLACK	Energy Star	1/5000	PA
■ L3AHW	662057997872	912401052148	3.75" ACCESSORY HOLDER WHITE	Energy Star	12/1008	PA
● L3ANE1	662057999333	912401052145	3.75" NEW CONSTRUCT. AIRSEAL IC 120V ELV DIM NAIL	-	1/90	CA, TN, PA
● L3CE1	662057999319	912401052147	3.75" REMODELER NON-IC 120V ELV DIM	-	1/60	PA
■ L3LS	190096135165	912401052151	3.75" LINEAR SPREAD FILM	Energy Star	1/140	TN
● L3NZ10U	662057999456	912401052146	3.75" NEW CONSTRUCT. NON-IC 120V/277 0-10V DIM SCR	-	1/90	TN, PA
<b>LyteCaster Conventional 3" Light Engine</b>						
■ L308827F	662057997995	912401052131	800lm 80CRI 2700K Flood Beam	Energy Star	1/336	Factory
■ L308827NF	662057997988	912401052129	800lm 80CRI 2700K Narrow Flood Beam	Energy Star	1/450	TN, PA
● L308830F	662057998053	912401052136	800lm 80CRI 3000K Flood Beam	-	1/336	CA, PA
● L308830NF	662057998015	912401052135	800lm 80CRI 3000K Narrow Flood Beam	-	1/336	TN
■ L308830S	662057998008	912401052137	800lm 80CRI 3000K Spot Beam	Energy Star	-	Factory
■ L308835F	662057998138	912401052142	800lm 80CRI 3500K Flood Beam	Energy Star	1/336	PA
■ L308835NF	662057998121	912401052141	800lm 80CRI 3500K Narrow Flood Beam	Energy Star	1/336	PA
● L308927F	662057998152	912401052132	800lm 2700K 90CRI Flood Beam	Energy Star	1/336	CA, PA
■ L308927NF	662057998183	912401052130	800lm 2700K 90CRI Narrow Flood Beam	Energy Star	1/336	PA
<b>LyteCaster LED 3" Round Light Trims</b>						
■ L3RABW	662057997643	912401050201	Adjustable Baffle Downlight Style White Finish White Flange	Energy Star	12/1152	PA
■ L3RAD	662057997667	912401050206	Adjustable Downlight Style Diffuse Cone Finish White Flange	Energy Star	12/1008	PA

- Stock Ready (returnable)
- Design Ready (non-returnable)



# LyteCaster LED Accent

(continued)



Catalog Number	UPC Code	Model Number	Product Description	Compliance	Case/Pallet Qty	Distribution Center
<b>LyteCaster LED 3" Round Light Trims (continued)</b>						
● L3RAW	662057997674	912401050205	Adjustable Downlight Style White Cone Finish White Flange	-	12/1008	PA
■ L3RAPA	662057997865	912401052126	Adjustable Pinhole Style Aluminum Finish Aluminum Flange	-	12/1152	PA
■ L3RAPW	662057997858	912401052125	Adjustable Pinhole Style White Finish / Flange	-	12/840	PA
● L3RBW	662057997605	912401050202	Baffle Downlight Style White Finish White Flange	-	12/1008	PA
● L3RDD	662057997629	912401052128	Downlight Style Diffuse Cone Finish White Flange	-	12/1152	PA
● L3RDW	662057997636	912401052127	Downlight Style White Cone Finish White Flange	-	12/840	CA, TN, PA
■ L3RGA	662057997841	912401052124	Gimbal Style Aluminum Finish Aluminum Flange	Energy Star	12/1008	PA
■ L3RGB	662057997834	912401052123	Gimbal Style Black Finish Black Flange	Energy Star	12/1152	PA
● L3RGW	662057997827	912401052122	Gimbal Style White Finish White Flange	-	12/1008	PA
■ L3RLWC	662057997704	912401052118	Wall Wash Style Chrome Cone Finish White Flange	Energy Star	12/1152	PA
■ L3RLWD	662057997711	912401050211	Wall Wash Style Diffuse Cone Finish White Flange	Energy Star	12/1008	PA
■ L3RLWW	662057997728	912401050210	Wall Wash Style White Cone Finish White Flange	Energy Star	12/1152	PA
■ L3RSA	662057997698	912401052119	Shower Light Wash Style Aluminum Flange	-	12/840	PA
● L3RSW	662057997681	912401050196	Shower Light Wash Style White Flange	-	12/1152	PA
<b>LyteCaster LED 3" Square Light Trims</b>						
■ L3SAD	662057997766	912401050198	Adjustable Downlight Style Diffuse Cone Finish White Flange	Energy Star	12/840	PA
■ L3SADA	662057997773	912401050199	Adjustable Downlight Style Diffuse Cone Finish Aluminum Flange	-	12/1152	PA
● L3SDD	662057997735	912401050212	Downlight Style Diffuse Cone Finish White Flange	-	12/840	PA
■ L3SDDA	662057997742	912401050208	Downlight Style Diffuse Cone Finish Aluminum Flange	Energy Star	12/1008	PA
● L3SDW	662057997759	912401050197	Downlight Style White Cone Finish White Flange	-	12/1152	PA
■ L3SLWA	662057997797	912401050209	Wall Wash Style Aluminum Cone Finish White Flange	-	12/1152	PA
■ L3SLWW	662057997780	912401050207	Wall Wash Style White Cone Finish White Flange	-	12/840	PA
■ L3SSA	662057997810	912401052121	Shower Light Wash Style Aluminum Flange	-	12/1152	PA
■ L3SSW	662057997803	912401052120	Shower Light Wash Style White Flange	-	12/1152	PA
<b>LyteCaster LED 3" Accessories</b>						
■ L3RPF	662057998220	912401052154	Replacement Optic - Flood Beam	Energy Star	-	PA
■ L3RPNF	662057998213	912401052153	Replacement Optic - Narrow Flood Beam	Energy Star	12/144	Factory
■ L3RPS	662057998206	912401052152	Replacement Optic - Spot Beam	Energy Star	12/144	Factory
■ L3SD	190096135257	912401052150	5° Diffusion Film	Energy Star	1/140	TN

- Stock Ready (returnable)
- Design Ready (non-returnable)





# LyteCaster

## Defining downlighting

Ideal general purpose downlighting solution, providing comfortable, quality light. Two lumen packages offered, downlight is wet location listed and comes in three trim options.



## Why choose LyteCaster?

- Sizes: 4", 5", and 6" round and square
- Efficacy: up to 90 lm/W
- Lumens: 650-2000
- Wattage: 7-20 W
- Voltage: 120V or 120V-277V
- CCT: 2700 K-4000 K
- CRI: 80 and 90 min
- Dimming: ELV/TRIAC and 0-10V
- Lifetime: 50,000 hour (L70)

### LyteCaster

Catalog Number	UPC Code	Model Number	Product Description	Compliance	Case/Pallet Qty	Dist. Center
<b>LyteCaster Conventional 3.75" Frames</b>						
● 2000AIC	784197200022	912400463984	Incandescent AirSeal IC New Construction Frame	-	2/126	PA
● 2000IC	784197200015	912400462002	Incandescent IC New Construction Frame	-	2/126	TN, PA
■ 2000P1	784197200060	912400462004	Incandescent Non-IC New Construction Frame with Box For Adjustable Accent	-	1/126	Factory
● 2002P1	784197146658	912400462016	Incandescent Non-IC New Construction Frame	-	6/162	PA
● 2003R	784197174590	912400491713	Incandescent Non-IC Remodeler Frame for 3.75" Apertures	-	6/480	PA
● 2003RS	784197176143	912400462018	Incandescent Non-IC Remodeler Frame for 4.125" Apertures	-	1/160	PA
● 2004ICV	784197239541	912400463997	Lytening Low Voltage MR16 Airseal IC Housing Magnetic Transformer with Screws 120V	-	1/36	PA
● 2004ICVN	784197238995	912400468426	Lytening Low Voltage MR16 Airseal IC Housing Magnetic Transformer with Nails 120v	-	1/36	TN
<b>LyteCaster Conventional 3.75" Trims</b>						
● 2005	784197146559	912400460286	Step Baffle Black Finish	-	1/660	TN
● 2005WH	784197200107	912400462026	Step Baffle White Finish	-	6/576	TN, PA
■ 2006	784197146566	912400460287	Adjustable Slot MR16 White Finish	-	-	Factory
■ 2011	784197146597	912400460290	Pinhole White Finish	-	1/528	Factory
● 2013	784197146627	912400460292	Cone Specular Clear Finish	-	6/576	PA
● 2013CD	784197359690	912400462032	Cone Clear Diffuse Finish	-	1/294	PA
● 2013WH	784197201302	912400462035	Cone White Finish	-	1/294	PA
● 2025WH	784197386962	912400462041	Mini Swivel Adjustable MR16 White Finish	-	1/294	PA
● 2027WH	784197200206	912400462044	Recessed Adjustable Step Baffle White Finish	-	1/294	PA
● 2076WH	662057206080	912400462056	Basic Baffle White Finish	-	6/576	PA
■ 2076WHS	662057206097	912400464004	Basic Baffle White Finish Gloss White Flange	-	1/294	PA
● 2090	784197501020	912400460302	Flat Glass Lens Clear Shower Light with Plastic White Flange (wet location)	-	1/294	PA

- Stock Ready (returnable)
- Design Ready (non-returnable)



# LyteCaster

(continued)



Catalog Number	UPC Code	Model Number	Product Description	Compliance	Case/Pallet Qty	Dist. Center
<b>LyteCaster Conventional 5" Frames</b>						
1000AICM	784197100056	912400468271	Incandescent AirSeal IC Frame	-	4/60	Factory
1000IC	784197119959	912400461789	Incandescent IC Frame	-	4/60	PA
1002P1	784197120078	912400461798	Incandescent Non-IC Frame	-	6/162	TN, PA
1002PJ	784197007690	912400461799	Incandescent Non-IC Frame (Thermally Protected)	-	1/90	PA
1003R	784197174576	912400491667	Incandescent Non-IC Remodeler Frame for 5" Apertures	-	6/480	PA
1003RS	784197176129	912400461801	Incandescent Non-IC Remodeler Frame for 5.25" Apertures	-	1/160	PA
1004ICNS	784197487737	912400468303	Lytening Non-IC & IC Housing with Preinstalled Nailer Bars	-	1/54	PA
1004ICS	784197176082	912400463898	Lytening Non-IC & IC Housing Can for use with 1000 series	-	1/54	PA
1004SICS	784197198510	912400468310	Lytening Non-IC & IC Shallow Housing Can Housing for use with 2x6 construction	-	1/54	PA
<b>LyteCaster Conventional 5" Trims</b>						
1005WH	784197100506	912400461808	Step Baffle White Finish	-	6/576	PA
1005WHS	784197513542	912400463904	Step Baffle White Finish Gloss White Flange	-	1/252	PA
1013	784197120450	912400460159	Cone Specular Clear Finish	-	6/576	PA
1013CD	784197359706	912400461817	Cone Clear Diffuse Finish	-	6/576	PA
1013S	784197513191	912400491668	Cone Specular Clear Finish	-	1/252	PA
1071	784197120696	912400460170	Open Reflector White Finish	-	6/576	PA
1076WH	784197107604	912400461847	Basic Baffle White Finish	-	6/432	TN, PA
1177LX	784197194758	912400461942	Flush Glass Shower Light with Plastic White Flange (wet location)	-	1/180	PA
1078	784197120719	912400460172	Dropped Opalex Shower Light White Finish (wet location)	-	6/180	Factory
1082	784197120733	912400460173	Basic Eyeball White Finish	-	1/252	Factory
1081WH	784197017132	912400461850	Open PAR30 Gloss White Finish Outdoor Rated (wet location)	-	1/504	CA
1084WH	784197017156	912400461856	Open PAR30L Gloss White Finish Outdoor Rated (wet location)	-	1/378	CA
1090	784197501006	912400460177	Flat Glass Lens Clear Shower Light with Plastic White Flange (wet location)	-	1/252	PA

- Stock Ready (returnable)
- Design Ready (non-returnable)





# LyteCaster

(continued)

Catalog Number	UPC Code	Model Number	Product Description	Compliance	Case/Pallet Qty	Dist. Center
<b>LyteCaster Conventional 6.75" Frames</b>						
■ 1100IC	784197110239	912400461862	Incandescent IC Frame	-	4/60	PA
■ 1101HCL	784197546144	912400463921	Compact Fluorescent Performance Horizontal Open CI	-	1/120	Factory
● 1102P1	784197110222	912400461868	Incandescent Non-IC Frame	-	6/162	TN, PA
● 1103R	784197174583	912400491677	Incandescent Remodeler Ring Non-IC Frame for 6.75" Apertures	-	6/480	PA
■ 1103RS	784197176136	912400461870	Incandescent Remodeler Ring Non-IC Frame for 7.125" Apertures	-	1/160	PA
● 1104IC	662057517995	912400461872	Lytening Incandescent New Construction Non-IC & IC Housing with Screws	-	8/72	PA
● 1104ICN	784197198589	912400463935	Lytening Incandescent New Construction Non-IC & IC Housing with Nails	-	8/72	PA
● 1104ICNQ	784197291815	912400468375	Lytening Incandescent New Construction Non-IC & IC Housing with Nails (Quick Connect)	-	8/72	TN
■ 1104ICNS	784197487744	912400468376	Lytening Non-IC & IC Housing with Preinstalled Nailers Bars	-	1/54	PA
■ 1104ICR	784197159337	912400463937	Lytening Incandescent Remodeler Non-IC & IC Housing with Screws	-	1/144	Factory
■ 1104ICS	784197176099	912400463938	Lytening Non-IC & IC Housing Can for use with 1100 series	-	1/54	Factory
● 1104ICX	784197219819	912400463939	Lytening Incandescent New Construction IC Housing with Screws	-	4/60	PA
● 1104ICXN	784197239015	912400468377	Lytening Incandescent New Construction IC Housing with Nails	-	4/60	TN
■ 1104SIC	784197198497	912400463940	Lytening Incandescent New Construction Non-IC & IC Shallow Housing with Screws	-	8/96	Factory
■ 1104SICR	784197198541	912400468381	Lytening Incandescent Remodeler Non-IC & IC Shallow Housing with Screws	-	1/144	PA
<b>LyteCaster Conventional 6.75" Trims</b>						
■ 1105	784197123154	912400460183	Step Baffle Black Finish	-	-	Factory
■ 1105WH	784197110703	912400461879	Step Baffle White Finish	-	6/360	PA
● 1113	784197123352	912400460187	Cone Specular Clear Finish	-	6/360	PA
● 1113CD	784197359713	912400461884	Cone Clear Diffuse Finish	-	1/180	Factory
■ 1113WH	784197011130	912400461888	Cone White Finish	-	-	Factory
■ 1113S	784197511449	912400491679	Cone Specular Clear Finish	-	1/180	Factory
● 1117WH	784197243609	912400461892	Baffle White Finish	-	48/864	CA
■ 1126	784197123789	912400460194	Regressed Fresnel Lens White Splay	-	1/120	Factory
● 1133WH	784197113322	912400461918	Slope Ceiling 30°-45° Baffle White Finish	-	1/120	PA
■ 1146	784197124175	912400460208	A Lamp Open Reflector Specular Clear Finish	-	1/180	Factory
■ 1154WH	784197017231	912400461935	Complete Slope Ceiling 14°-45° Baffle White Finish	-	1/120	TN
● 1171	784197117108	912400460219	Open Reflector White Finish	-	6/360	PA
● 1176	784197003500	912400460220	Basic Baffle Black Finish	-	6/360	TN
● 1176WH	784197003517	912400461941	Basic Baffle White Finish	-	6/360	TN, PA
■ 1176PANEW	784197120351	912400470344	Basic Baffle Black Finish	-	1/120	PA
● 1176WHSNEW	784197120368	912400472652	Basic Baffle White Finish	-	1/88	PA
■ 1177SH	784197117719	912400461944	Flush Opalex Shower Light with Plastic White Flange (wet location)	-	6/216	Factory
■ 1178SH	784197117818	912400461946	Drop Opalex Shower Light with Plastic White Flange (wet location)	-	1/180	TN
● 1182	784197118204	912400460221	Basic Eyeball White Finish	-	1/180	TN
■ 1190	784197501013	912400460224	Flat Glass Lens Clear Shower Light with Plastic White Flange (wet location)	-	-	Factory
<b>LyteCaster Conventional Accessories</b>						
■ 1955	784197145125	912400460249	Retaining Clip	-	100/400	Factory
■ 1956	784197145132	912400460250	Set of 4 Mounting Bar Clips	-	12/3024	PA

● Stock Ready (returnable)  
 ■ Design Ready (non-returnable)



# CorePro LED Downlight



## Low cost

The CorePro LED downlight family is Lightolier's low cost LED recessed downlight.

## Why choose CorePro LED Downlight?

- Affordable solution for retrofit, new construction or remodeling
- Save up to 85% in energy cost compared to 65W & 75W incandescent light source
- Compatible with many Lightolier brand or competitive housings



## CorePro LED Downlight

Catalog Number	UPC Code	Model Number	Product Description	Compliance	Case/Pallet Qty	Distribution Center
<b>CorePro LED 4" Downlight</b>						
CP4RB07830W	662057939018	912401052602	800lm 80CRI 3000K White Finish 120V	Energy Star/Title 24	12/576	PA
CP4RB07840W	662057939025	912401052603	850lm 80CRI 4000K White Finish 120V	Energy Star/Title 24	12/576	PA
CP4RB07930W	662057939001	912401052601	750lm 90CRI 3000K White Finish 120V	Energy Star/Title 24	12/576	PA
CP4RN	662057939094	912401052610	New Construction Frame	-	6/210	PA
CP4RR	662057939100	912401052611	New Remodeler Housing	Energy Star/Title 24	6/252	PA
<b>CorePro LED 5" Downlight</b>						
CP5RB08830W	662057939049	912401052605	950lm 80CRI 3000K White Finish 120V	Energy Star/Title 24	12/324	CA, TN, PA
CP5RB08840W	662057939056	912401052606	1000lm 80CRI 4000K White Finish 120V	Energy Star/Title 24	12/324	PA
CP5RB08930W	662057939032	912401052604	900lm 90CRI 3000K White Finish 120V	Energy Star/Title 24	12/324	PA
CP5RN	662057939117	912401052612	New Construction Frame	Title 24	6/168	PA
CP5RR	662057939124	912401052613	New Remodeler Housing	Title 24	6/144	PA
<b>CorePro LED 6" Downlight</b>						
CP6RB07830W	662057939254	912401052617	835lm 80CRI 3000K White Finish 120V	Energy Star/Title 24	12/192	CA, TN, PA
CP6RB10830W	662057939070	912401052608	1200lm 80CRI 3000K White Finish 120V	Energy Star/Title 24	12/192	CA, TN, PA
CP6RB10840W	662057939087	912401052609	1250lm 80CRI 4000K White Finish 120V	Energy Star/Title 24	12/192	CA, TN, PA
CP6RB10930W	662057939063	912401052607	1000lm 90CRI 3000K White Finish 120V	Energy Star/Title 24	12/192	PA
CP6RN	662057939131	912401052614	New Construction Frame	Energy Star/Title 24	6/144	CA, TN, PA
CP6RR	662057939148	912401052615	New Remodeler Housing	Energy Star/Title 24	6/168	PA

- Stock Ready (returnable)
- Design Ready (non-returnable)





Mini Downlight



Mini Gimbal

# Mini Downlight and Mini Gimbal

Emphasize without the size



## Why choose Mini Downlight and Mini Gimbal?

- Sizes: 3 inch round
- Dimming: TRIAC down to 10%
- Installation: Easy with detachable junction box
- Lifetime: L70 at 50,000 hours
- Listings: ENERGY STAR®, Title 24 (JA8-2016), damp location, ETL listed, Airseal IC.
- Warranty: 5 year limited

### Mini Downlight and Mini Gimbal

Catalog Number	UPC Code	Model Number	Product Description	Compliance	Case/Pallet Qty	Distribution Center
<b>Mini Downlight 3"</b>						
MD3R069301FW	190096017409	912400543533	550lm 90CRI 3000K Flood Beam White Finish 120V	Energy Star/Title 24	18/1224	PA
<b>Mini Gimbal 3"</b>						
MG3R06930NF1W	190096017270	912400543520	550lm 90CRI 3000K Narrow Flood Beam White Finish 120V	Energy Star/Title 24	18/432	PA
<b>Mini Downlight &amp; Mini Gimbal Accessories</b>						
MD06C	190096017331	912400543526	6' Extension Cord	-	50/3000	PA
MD20C	190096017348	912400543527	20' Extension Cord	-	50/3000	PA
MDRN	190096017355	912400543528	Round New Construction Plate	-	50/1200	PA

- Stock Ready (returnable)
- Design Ready (non-returnable)



# EasyLyte LED



## Ease and quality

Lightolier EasyLyte LED downlight is the best choice for the money without sacrificing ease of install or product quality.

## Why choose EasyLyte LED?

- Unitized optics with 70° cut off ensure proper positioning of light source to ensure expected lighting distribution
- Field adjustable springs accommodate ceiling thicknesses of 1.5" (4") and 2" (6") fixtures
- Polycarbonate round aperture trim inserts offer splay and baffle finish options in both 4" and 6" round sizes
- Tool-free install using modular quick connects
- Emergency frame option with emergency battery pack and remote test switch



## EasyLyte LED

Catalog Number	UPC Code	Model Number	Product Description	Compliance	Case/Pallet Qty	Distribution Center
<b>EasyLyte LED 4"</b>						
■ Z4RDL10835WOCDE1	190096106585	912400547901	1000lm 80CRI 3500K Open Style Style Clear Diffuse Finish ELV 120V	Energy Star	1/96	Factory
● Z4RDL10835WOCZ10U	190096103072	912400546538	1000lm 80CRI 3500K Open Style Clear Diffuse Finish 0-10V UNV	Energy Star	1/96	PA, IL, GA*
■ Z4RDL10835WOWHZ10U	190096106578	912400547899	1000lm 80CRI 3500K Open Style White Finish (matte) 0-10V UNV	Energy Star	1/96	Factory
■ Z4RDL10840WOCDE1	190096106622	912400547905	1000lm 80CRI 4000K Open Style Clear Diffuse Finish ELV 120V	Energy Star	1/96	Factory
■ Z4RDL10840WOCZ10U	190096106639	912400547906	1000lm 80CRI 4000K Open Style Clear Diffuse Finish 0-10V UNV	Energy Star	1/96	TN, GA*
■ Z4RDL15830WOCDE1	190096106677	912400547910	1500lm 80CRI 3000K Open Style Clear Diffuse Finish ELV 120V	Energy Star	1/96	Factory
■ Z4RDL15830WOCZ10U	190096103232	912400546573	1500lm 80CRI 3000K Open Style Clear Diffuse Finish 0-10V UNV	Energy Star	1/96	TN
■ Z4RDL15835WOCDE1	190096103089	912400546539	1500lm 80CRI 3500K Open Style Clear Diffuse Finish ELV 120V	Energy Star	1/96	Factory
● Z4RDL15835WOCZ10U	190096103096	912400546540	1500lm 80CRI 3500K Open Style Clear Diffuse Finish 0-10V UNV	Energy Star	1/96	TN, GA*
■ Z4RDL15835WOWHE1	190096106684	912400547911	1500lm 80CRI 3500K Open Style White Finish (matte) ELV 120V	Energy Star	1/96	Factory
■ Z4RDL15835WOWHZ10U	190096106691	912400547912	1500lm 80CRI 3500K Open Style White Finish (matte) 0-10V UNV	Energy Star	1/96	Factory
■ Z4RDL15835WSWHZ10U	190096103430	912400546566	1500lm 80CRI 3500K Steo Baffle Style White Finish (matte) 0-10V UNV	Energy Star	1/96	Factory
■ Z4RDL15840WOCDE1	190096106752	912400547919	1500lm 80CRI 4000K Open Style Clear Diffuse Finish ELV 120V	Energy Star	1/96	Factory
■ Z4RDL15840WOCZ10U	190096103102	912400546541	1500lm 80CRI 4000K Open Style Clear Diffuse Finish 0-10V UNV	Energy Star	1/96	TN, GA*
■ Z4RDL15840WOWHZ10U	190096106745	912400547918	1500lm 80CRI 4000K Open Style White Finish (matte) 0-10V UNV	Energy Star	1/96	Factory
■ Z4RDL20830WOCZ10U	190096106806	912400547924	2000lm 80CRI 3000K Open Style Clear Diffuse Finish 0-10V UNV	Energy Star	1/96	TN
■ Z4RDL20835WOCDE1	190096106820	912400547926	2000lm 80CRI 3500K Open Style Clear Diffuse Finish ELV 120V	Energy Star	1/96	Factory
● Z4RDL20835WOCZ10U	190096103119	912400546542	2000lm 80CRI 3500K Open Style Clear Diffuse Finish 0-10V UNV	Energy Star	1/96	TN,GA*
■ Z4RDL20835WOWHZ10U	190096106813	912400547925	2000lm 80CRI 3500K Open Style White Finish (matte) 0-10V UNV	Energy Star	1/96	Factory
■ Z4RDL20840WOCDE1	190096106868	912400547930	2000lm 80CRI 4000K Open Style Clear Diffuse Finish ELV 120V	Energy Star	1/96	Factory

- Stock Ready (returnable)
- Design Ready (non-returnable)





# EasyLyte LED

(continued)

Catalog Number	UPC Code	Model Number	Product Description	Compliance	Case/Pallet Qty	Distribution Center
<b>EasyLyte LED 4" (continued)</b>						
■ Z4RDL20840WOCZ10U	190096106875	912400547931	2000lm 80CRI 4000K Open Style Clear Diffuse Finish 0-10V UNV	Energy Star	1/96	Factory
■ Z4RDL25835WOCZ10U	190096106905	912400547934	2500lm 80CRI 3500K Open Style Clear Diffuse Finish 0-10V UNV	Energy Star	1/96	Factory
■ Z4RDL25840WOCZ10U	190096106929	912400547936	2500lm 80CRI 4000K Open Style Clear Diffuse Finish 0-10V UNV	Energy Star	1/96	Factory
<b>EasyLyte LED 6"</b>						
■ Z6RDL10835WOCDE1	190096106950	912400547939	1000lm 80CRI 3500K Open Style Clear Diffuse Finish ELV 120V	Energy Star	1/96	Factory
● Z6RDL10835WOCZ10U	190096103126	912400546543	1000lm 80CRI 3500K Open Style Clear Diffuse Finish 0-10V UNV	Energy Star	1/96	TN, GA*
■ Z6RDL10835WOWHZ10U	190096106943	912400547938	1000lm 80CRI 3500K Open Style White Finish (matte) 0-10V UNV	Energy Star	1/96	Factory
■ Z6RDL10840WOCZ10U	190096106974	912400547941	1000lm 80CRI 4000K Open Style Clear Diffuse Finish 0-10V UNV	Energy Star	1/96	TN, GA*
■ Z6RDL15830WOCZ10U	190096107001	912400547944	1500lm 80CRI 3000K Open Style Clear Diffuse Finish 0-10V UNV	Energy Star	1/96	TN
■ Z6RDL15835WOCDE1	190096103133	912400546544	1500lm 80CRI 3500K Open Style Clear Diffuse Finish ELV 120V	Energy Star	1/96	Factory
● Z6RDL15835WOCZ10U	190096103140	912400546545	1500lm 80CRI 3500K Open Style Clear Diffuse Finish 0-10V UNV	Energy Star	1/96	PA, GA*
■ Z6RDL15835WOWHZ10U	190096103287	912400546567	1500lm 80CRI 3500K Open Style White Finish (matte) 0-10V UNV	Energy Star	1/96	Factory
■ Z6RDL15835WSWHZ10U	190096107032	912400547947	1500lm 80CRI 3500K Step Baffle Style White Finish (matte) 0-10V UNV	Energy Star	1/96	Factory
■ Z6RDL15840WOCDE1	190096107070	912400547951	1500lm 80CRI 4000K Open Style Clear Diffuse Finish ELV 120V	Energy Star	1/96	Factory
● Z6RDL15840WOCZ10U	190096103157	912400546546	1500lm 80CRI 4000K Open Style Clear Diffuse Finish 0-10V UNV	Energy Star	1/96	TN, GA*
■ Z6RDL15840WOWHZ10U	190096107063	912400547950	1500lm 80CRI 4000K Open Style White Finish (matte) 0-10V UNV	Energy Star	1/96	Factory
■ Z6RDL20830WOCDE1	190096107117	912400547955	2000lm 80CRI 3000K Open Style Clear Diffuse Finish ELV 120V	Energy Star	1/96	Factory
■ Z6RDL20830WOCZ10U	190096107124	912400547956	2000lm 80CRI 3000K Open Style Clear Diffuse Finish 0-10V UNV	Energy Star	1/96	TN
■ Z6RDL20835WOCDE1	190096103164	912400546547	2000lm 80CRI 3500K Open Style Clear Diffuse Finish ELV 120V	Energy Star	1/96	Factory
● Z6RDL20835WOCZ10U	190096103171	912400546548	2000lm 80CRI 3500K Open Style Clear Diffuse Finish 0-10V UNV	Energy Star	1/96	TN, GA*
■ Z6RDL20835WOWHE1	190096107148	912400547958	2000lm 80CRI 3500K Open Style White Finish (matte) ELV 120V	Energy Star	1/96	Factory
■ Z6RDL20835WOWHZ10U	190096107155	912400547959	2000lm 80CRI 3500K Open Style White Finish (matte) 0-10V UNV	Energy Star	1/96	Factory
■ Z6RDL20835WSWHZ10U	190096107186	912400549679	2000lm 80CRI 3500K Step Baffle Style White Finish (matte) 0-10V UNV	Energy Star	1/96	Factory
■ Z6RDL20840WOCDE1	190096107216	912400549682	2000lm 80CRI 4000K Open Style Clear Diffuse Finish ELV 120V	Energy Star	1/96	Factory
■ Z6RDL20840WOCZ10U	190096103195	912400546550	2000lm 80CRI 4000K Open Style Clear Diffuse Finish 0-10V UNV	Energy Star	1/96	TN, GA*
■ Z6RDL20840WOWHZ10U	190096107209	912400549681	2000lm 80CRI 4000K Open Style White Finish (matte) 0-10V UNV	Energy Star	1/96	Factory
■ Z6RDL25830WOCZ10U	190096107285	912400549688	2500lm 80CRI 3000K Open Style Clear Diffuse Finish 0-10V UNV	Energy Star	1/96	TN
■ Z6RDL25835WOCZ10U	190096103201	912400546551	2500lm 80CRI 3500K Open Style Clear Diffuse Finish 0-10V UNV	Energy Star	1/96	TN, GA*
■ Z6RDL25835WOWHZ10U	190096107292	912400549689	2500lm 80CRI 3500K Open Style White Finish (matte) 0-10V UNV	Energy Star	1/96	Factory
■ Z6RDL35830WOCZ10U	190096107438	912400549704	3500lm 80CRI 3000K Open Style Clear Diffuse Finish 0-10V UNV	Energy Star	1/96	Factory
■ Z6RDL35835WOCZ10U	190096103225	912400546553	3500lm 80CRI 3500K Open Style Clear Diffuse Finish 0-10V UNV	Energy Star	1/96	Factory
■ Z6RDL35840WOCZ10U	190096107469	912400549707	3500lm 80CRI 4000K Open Style Clear Diffuse Finish 0-10V UNV	Energy Star	1/96	Factory

● Stock Ready (returnable)  
 ■ Design Ready (non-returnable)



# Flat Downlight Select

Make your next lighting project faster and easier, with a product from a name you can trust.



## Why choose Flat Downlight Select?

- Field selectable color temperature
- Quick and easy installation without frame or reflector
- 1/2" depth luminaire and 1" deep junction box are ideal for shallow plenum or use under joist
- Junction box clips to luminaire meeting National Electric Code (NEC)
- Dimmable to 10%. Lifetime >50,000 hours (L70)
- IC-rated for direct contact with insulation. UL1598 wet location rated



## Flat Downlight Select

Catalog Number	UPC Code	Model Number	Product Description	Compliance	Case/Pallet Qty	Distribution Center
<b>Flat Downlight Select 4"</b>						
FD4R4CCT	784197681272	912401510528	700lm 90CRI 2700K/3000K/4000K/5000K White Finish 120V	Energy Star/RoHS	24/480	CA, TN, PA, GA*
FD4NCP	190096131198	911401865081	New Construction Plate	-	40/2800	TN
FD4TBK	190096131228	911401865381	Black Trim Facia	-	144/3456	TN
FD4TBN	190096131242	911401865581	Brushed Nickel Trim Facia	-	144/3456	TN
<b>Flat Downlight Select 6"</b>						
FD6R4CCT	784197681289	912401510529	900lm 90CRI 2700K/3000K/4000K/5000K White Finish 120V	Energy Star/RoHS	24/288	CA, TN, PA, GA*
FD6NCP	190096131204	911401865181	New Construction Plate	-	40/2000	TN
FD6TBK	190096131235	911401865481	Black Trim Facia	-	144/1728	TN
FD6TBN	190096131259	911401865681	Brushed Nickel Trim Facia	-	144/1728	TN
<b>Flat Downlight Select Accessory</b>						
FD10EC	190096131211	911401865281	10ft Extension Cable	-	144/1728	TN

- Stock Ready (returnable)
- Design Ready (non-returnable)



2000lm



600lm/1000lm

# OmniSpot LED

## Small is the new big

These luminaires are no exception. Combining compact design with power to keep attention focused exactly on designated areas of interest.

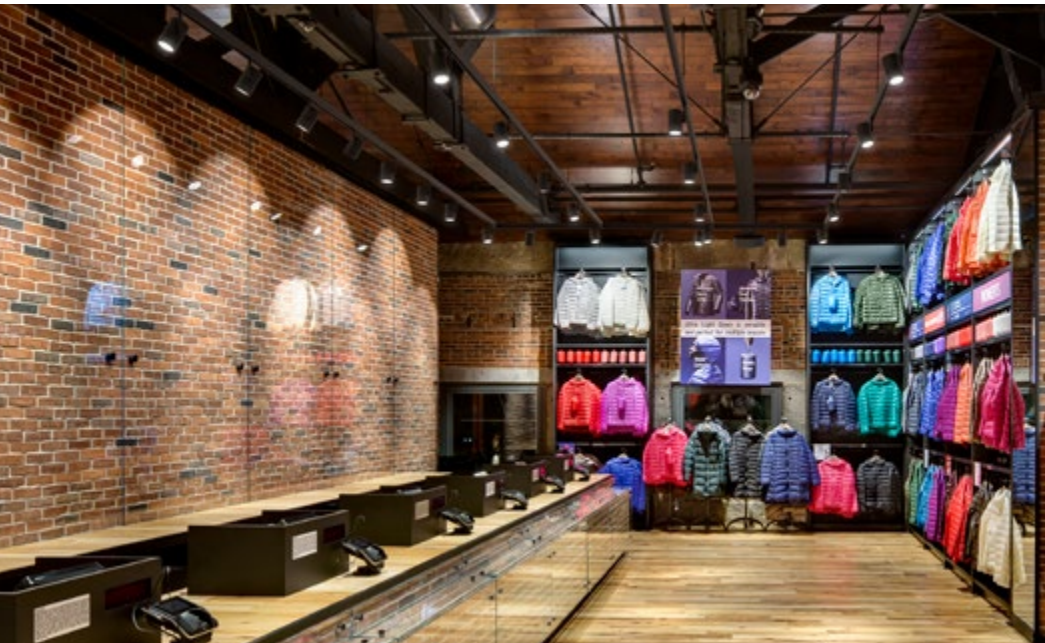

## Why choose OmniSpot LED?

- Compact, sleek aesthetic with no visible heat sink
- Excellent beam control with industry leading center beam candlepower up to 30,000
- Unobtrusive track head at less than 1" of space between the track and track head
- 6 different track adapters available, making installation a breeze
- Superior optical control designed for retail

### OmniSpot LED

Catalog Number	UPC Code	Model Number	Product Description	Compliance	Case/Pallet Qty	Distribution Center
<b>OmniSpot LED 600lm/1000lm with Lightlier Track Adapter</b>						
■ LC06830BKTE	190096036783	912400539840	600lm 80CRI 3000K Black Finish ELV 120V	Energy Star/RoHS	-	Factory
■ LC06830WTE	190096037629	912400539839	600lm 80CRI 3000K White Finish ELV 120V	Energy Star/RoHS	1/336	TN
■ LC10830BKTE	190096036790	912400539858	1000lm 80CRI 3000K Black Finish ELV 120V	Energy Star/RoHS	-	Factory
● LC10830WTE	190096037445	912400539857	1000lm 80CRI 3000K White Finish ELV 120V	Energy Star	1/336	PA
■ LCL10930BKTE	190096031665	912400541633	1000lm 90CRI 3000K Black Finish ELV 120V	Energy Star/RoHS	-	Factory
■ LCL10930WTE	190096031658	912400541632	1000lm 90CRI 3000K White Finish ELV 120V	Energy Star/RoHS	1/336	Factory
■ LCL10CW30BKTE	190096037636	912400539869	1000lm 90CRI 3000K White Finish ELV 120V CrispWhite	Energy Star/RoHS	1/336	Factory
<b>OmniSpot LED 600lm/1000lm with Juno Track Adapter</b>						
■ LCJ10830BKTE	190906020988	912400540046	1000lm 80CRI 3000K Black Finish ELV 120V	Energy Star/RoHS	-	Factory
■ LCJ10830WTE	190906020971	912400540045	1000lm 80CRI 3000K White Finish ELV 120V	Energy Star/RoHS	-	Factory
■ LCJ10930BKTE	190096033799	912400541663	1000lm 90CRI 3000K Black Finish ELV 120V	Energy Star/RoHS	-	Factory
■ LCJ10930WTE	190096033782	912400541662	1000lm 90CRI 3000K White Finish ELV 120V	Energy Star/RoHS	-	Factory
■ LCJ10CW30BKTE	190906021121	912400540058	1000lm 90CRI 3000K Black Finish ELV 120V CrispWhite	Energy Star/RoHS	-	Factory
■ LCJ10CW30WTE	190906021114	912400540057	1000lm 90CRI 3000K White Finish ELV 120V CrispWhite	Energy Star/RoHS	-	Factory

- Stock Ready (returnable)
- Design Ready (non-returnable)



# OmniSpot LED

(continued)



Catalog Number	UPC Code	Model Number	Product Description	Compliance	Case/Pallet Qty	Distribution Center
<b>OmniSpot LED 600lm/1000lm Accessories</b>						
■ LC10AHAL	190096028870	912400540139	Small Accessory Holder Aluminum Finish	Energy Star/RoHS	-	PA
■ LC10AHBK	190096028863	912400540138	Small Accessory Holder Black Finish	Energy Star/RoHS	30/720	PA
■ LC10AHHW	190096028856	912400540137	Small Accessory Holder White Finish	Energy Star/RoHS	1/1	PA
■ LC10FR	190096029013	912400540152	Small Frosted Etched Diffusion Film	Energy Star/RoHS	1/140	PA
■ LC10LS	190096029020	912400540153	Small Linear Spread Diffusion Film	Energy Star/RoHS	1/140	PA
● LC10SF	190096029006	912400540151	Small Soft Focus Diffusion Film	-	1/140	PA
■ LC10SY	190096028993	912400540150	Small Symmetrical Spread Diffusion Film	Energy Star/RoHS	1/140	CA
■ LC10SNAL	190096014750	912400540146	Small Snoot Aluminum Finish	Energy Star/RoHS	1/1	PA
■ LC10SNBK	190096014743	912400540145	Small Snoot Black Finish	Energy Star/RoHS	1/1	PA
■ LC10SNWH	190096014736	912400540144	Small Snoot White Finish	Energy Star/RoHS	1/1	PA
<b>OmniSpot LED 20000lm with Lightolier Track Adapter</b>						
■ LC20830BKTE	662057970523	912400537828	2000lm 80CRI 3000K Black Finish ELV 120V	Energy Star/RoHS	-	Factory
■ LCL20930WHTTE	190096028153	912400541635	2000lm 90CRI 3000K White Finish ELV 120V	Energy Star/RoHS	-	Factory
■ LCL20930BKTE	190096031894	912400541636	2000lm 90CRI 3000K Black Finish ELV 120V	Energy Star/RoHS	1/192	TN
■ LCL20CW30WHTTE	190096037643	912400539875	2000lm 90CRI 3000K White Finish ELV 120V CrispWhite	Energy Star/RoHS	1/192	CA
■ LCL20CW30BKTE	190096041114	912400539876	2000lm 90CRI 3000K Black Finish ELV 120V CrispWhite	Energy Star/RoHS	1/192	CA
<b>OmniSpot LED 20000lm with Juno Track Adapter</b>						
■ LCJ20830BKTE	19096021183	912400540064	2000lm 80CRI 3000K Black Finish ELV 120V	Energy Star/RoHS	-	Factory
■ LCJ20830WTE	19096021176	912400540063	2000lm 90CRI 3000K White Finish ELV 120V	Energy Star/RoHS	-	Factory
■ LCJ20930BKTE	190096033843	912400541666	2000lm 90CRI 3000K Black Finish ELV 120V	Energy Star/RoHS	-	Factory
■ LCJ20930WHTTE	190096033836	912400541665	2000lm 90CRI 3000K White Finish ELV 120V	Energy Star/RoHS	-	Factory
■ LCJ20CW30BKTE	19096021305	912400540076	2000lm 90CRI 3000K Black Finish ELV 120V CrispWhite	Energy Star/RoHS	-	Factory
■ LCJ20CW30WHTTE	19096021299	912400540075	2000lm 90CRI 3000K White Finish ELV 120V CrispWhite	Energy Star/RoHS	-	Factory
<b>OmniSpot LED 20000lm Accessories</b>						
■ LC20AHBK	190096028894	912400540141	Medium Accessory Holder Black Finish	Energy Star/RoHS	30/720	PA
■ LC20AHHW	190096028887	912400540140	Medium Accessory Holder White Finish	Energy Star/RoHS	1/1	PA
■ LC20FR	190096029051	912400540156	Medium Frosted Etched Diffusion Film	Energy Star/RoHS	1/140	PA
■ LC20LS	190096029068	912400540157	Medium Linear Spread Diffusion Film	Energy Star/RoHS	1/140	PA
■ LC20SF	190096029044	912400540155	Medium Soft Focus Diffusion Film	Energy Star/RoHS	1/140	CA
■ LC20SY	190096029037	912400540154	Medium Symmetrical Spread Diffusion Film	Energy Star/RoHS	1/140	Factory
■ LC20SNAL	190096014781	912400540149	Medium Snoot Aluminum Finish	Energy Star/RoHS	1/1	PA
■ LC20SNBK	190096014774	912400540148	Medium Snoot Black Finish	Energy Star/RoHS	1/1	PA
● LC20HC	190096030187	912400540143	Medium Hex Cell Louver Black Finish	-	1/140	PA
<b>OmniSpot LED Recessed Multiples</b>						
■ LCRM10H2	190096072118	912400540840	1000lm 2-Head UNV Housing	Energy Star	1/40	PA
■ LCRM10830H2WHZ10U	190096073887	912400540909	1000lm 80CRI 3000K White Finish 2-Head 0-10V UNV	Energy Star	1/60	PA
■ LCRM10CW30H2WHTZ10U	190096074419	912400542830	1000lm 90CRI 3000K White Finish 2-Head 0-10V UNV CrispWhite	Energy Star	1/60	Factory
■ LCRM10H3	190096072125	912400540841	1000lm 3-Head UNV Housing	Energy Star	1/40	Factory
■ LCRM10830H3WHZ10U	190096073894	912400540910	1000lm 80CRI 3000K White Finish 3-Head 0-10V UNV	Energy Star	1/140	PA
■ LCRM10CW30H3WHTZ10U	190096074426	912400542831	1000lm 90CRI 3000K White Finish 3-Head 0-10V UNV CrispWhite	Energy Star	1/140	Factory
● LLMRP	190096028849	912400540136	Small Reflector Flood Beam Reflector	-	1/378	CA, PA
● LLMRNF	190096028832	912400540135	Small Reflector Narrow Flood Beam Reflector	-	30/330	PA
■ LLMRS	190096028825	912400540134	Small Reflector Spot Beam Reflector	-	30/720	PA

- Stock Ready (returnable)
- Design Ready (non-returnable)





# Alcyon LED

## The quick and easy install solution

Ideal for display, accent and task lighting and offer higher efficiency than incandescent or halogen sources leading to energy savings with no ultraviolet or infrared radiation.



## Why choose Alcyon LED?

- Market leading efficiency and “candlepower punch”
- Tool-less aiming, tilt and pull-down design
- 3-part system designed for high performing, target illumination

### Alcyon LED

Catalog Number	UPC Code	Model Number	Product Description	Compliance	Case/Pallet Qty	Distribution Center
<b>Alcyon LED Recessed Multiples</b>						
■ LLAVRM11H1120	662057913438	912400527070	1000/1400lm 120V 1-Head Housing	Energy Star	1/40	PA
■ LLAVRM11H2120	662057913452	912400527072	1000/1400lm 120V 2-Head Housing	Energy Star	1/48	Factory
■ LLAVRM11H2277	662057913476	912400527073	1000/1400lm 277V 2-Head Housing	Energy Star	-	Factory
■ LLAVRM11H3120	662057913490	912400527074	1000/1400lm 120V 3-Head Housing	Energy Star	1/24	Factory
■ LLAVRM11H3277	662057913506	912400527075	1000/1400lm 277V 3-Head Housing	Energy Star	-	Factory
■ LLAVRM11H4277	662057913537	912400527077	1000/1400lm 277V 4-Head Housing	Energy Star	-	Factory
■ LLAVRM12H2120	662057913568	912400527080	2000lm 120V 2-Head Housing	Energy Star	1/42	Factory
■ LLAVRM12H3120	662057913582	912400527082	2000lm 120V 3-Head Housing	Energy Star	1/21	Factory
■ LLAVRM12H4120	662057913605	912400527084	2000lm 120V 4-Head Housing	Energy Star	1/140	Factory
■ LLAVRMWH1130H2	662057912943	912400527025	1400lm 80CRI 3000K White Finish 2-Head	Energy Star	1/30	Factory
■ LLAVRMWH1130H3	662057912967	912400527027	1400lm 80CRI 3000K White Finish 3-Head	Energy Star	1/36	Factory
<b>Alcyon LED Horizontal Track Heads</b>						
■ LLAH11830WTE	662057983578	912401050170	1100lm 80CRI 3000K White Finish ELV/Triac	Energy Star	1/120	PA
■ LLAH11835WTE	662057983608	912401050173	1100lm 80CRI 3500K White Finish ELV/Triac	Energy Star	1/120	Factory
■ LLAH11930WTECW	662057983714	912401050182	1100lm 90CRI 3000K White Finish ELW/Triac CrispWhite	Energy Star	1/120	TN
■ LLA01AHBK	662057287768	912400471825	Accessory Holder Black Finish	-	1/2520	PA
■ LLA01AHWH	662057287751	912400471826	Accessory Holder White Finish	-	150/1800	PA
■ LLA01SNWH	662057287706	912400471828	Snoot White Finish	-	1/2520	PA
■ LLRF	190096135592	912401050187	Flood Beam Reflector	-	1/378	PA
■ LLRNF	190096135608	912401050186	Narrow Flood Beam Reflector	-	1/378	Factory

- Stock Ready (returnable)
- Design Ready (non-returnable)



# Alcyon LED

(continued)



Catalog Number	UPC Code	Model Number	Product Description	Compliance	Case/Pallet Qty	Distribution Center
<b>Alcyon LED Vertical 1300lm Track Heads</b>						
■ LLAV1130BK	662057542041	912400526404	1300lm 80CRI 3000K Black Finish	Energy Star	1/240	Factory
■ LLAV1130WH	662057542034	912400526405	1300lm 80CRI 3000K White Finish	Energy Star	1/240	Factory
■ LLAV11AHAL	662057898261	912400526316	Accessory Holder Aluminum Finish	Energy Star	1/378	PA
■ LLAV11AHWH	662057898247	912400525203	Accessory Holder White Finish	Energy Star	1/378	Factory
■ LLAV11FR	662057898582	912400526277	Frosted Etched Diffusion Film	Energy Star	1/140	Factory
■ LLAV11LS	662057898520	912400526271	Linear Spread Diffusion Film	Energy Star	1/140	Factory
■ LLAV11SF	662057898568	912400526275	Soft Focus Diffusion Film	Energy Star	1/140	Factory
■ LLAV11SY	662057898544	912400526273	Symmetrical Spread Diffusion Film	Energy Star	1/140	PA
■ LLA11SNWH	662057287720	912400471840	Snoot White Finish	-	1/2520	PA
■ LLA11SNBK	662057287737	912400471839	Snoot Black Finish	-	1/2520	PA
■ LLAHCA11	662057287812	912400492415	Hex Cell Louver Black Finish	-	1/1	PA
● LLAV11RF	662057896809	912400520464	Flood Beam Reflector	-	1/336	CA
● LLAV11RNF	662057896816	912400520529	Narrow Flood Beam Reflector	-	1/336	CA, PA
■ LLAV11RNS	662057896793	912400520530	Narrow Spot Beam Reflector	Energy Star	1/336	Factory
● LLAV11RS	662057897110	912400520465	Spot Beam Reflector	-	1/336	PA
<b>Alcyon LED Vertical 2000lm/3000lm Track Heads</b>						
■ LLAV2030BK	662057949741	912401052796	2000lm 80CRI 3000K Black Finish	Energy Star	1/240	TN
■ LLAV2030WH	662057949734	912401052795	2000lm 80CRI 3000K White Finish	Energy Star	1/240	Factory
■ LLAV20930WHCW	662057949826	912401052805	2000lm 90CRI 3000K White Finish CrispWhite	Energy Star	-	Factory
■ LLAV3030BK	190096019502	912401053470	3000lm 80CRI 3000K Black Finish	Energy Star	-	Factory
■ LLAV12RF	662057896779	912400520466	Flood Beam Reflector	Energy Star	1/336	Factory
■ LLAV12RNS	662057896786	912400520532	Narrow Spot Beam Reflector	Energy Star	1/336	PA
■ LLAV12RS	662057896755	912400520467	Spot Beam Reflector	Energy Star	1/336	Factory

- Stock Ready (returnable)
- Design Ready (non-returnable)







# BoldFlood LED

Magnificent colors,  
effortlessly and efficiently



## Why choose BoldFlood LED?

- High efficacy with the best in flood and wall wash performance
- Designed to maintain high quality performance and rich color saturation
- Available in 2000lm and 4000lm with industry leading price per foot value
- Perfect for illuminating any retail wall display or wall application

### BoldFlood LED

Catalog Number	UPC Code	Model Number	Product Description	Compliance	Case/Pallet Qty	Distribution Center
<b>BoldFlood LED Track Heads</b>						
■ LWW20930WH	190096136391	912400543613	2000lm 90CRI 3000K White Finish	Energy Star	1/140	PA
■ LWW20935WH	190096136407	912400543616	2000lm 90CRI 3500K White Finish	Energy Star	1/140	PA
■ LWW40930WH	190096136414	912400543628	4000lm 90CRI 3000K White Finish	Energy Star	1/140	PA
■ LWW40935WH	190096136421	912400543631	4000lm 90CRI 3500K White Finish	Energy Star	1/140	PA
<b>BoldFlood LED Accessories</b>						
■ 81LV4BK	662057226606	912400466848	Louwer Wall Washer T4 Black Finish	Energy Star	1/1	PA
■ 81VZ4BK	662057226583	912400543581	Visor Wall Washer Black Finish	Energy Star	1/1	PA
■ 81VZ4WH	#N/A	912400543582	Visor Wall Washer White Finish	Energy Star	1/1	PA

- Stock Ready (returnable)
- Design Ready (non-returnable)



# CorePro LED Track

## Designed with simplicity in mind

The Lightolier CorePro LED Mini Cylinder is small and sleek for lower mounting heights and smaller spaces.



## Why choose CorePro LED Track?

- Consumes 82% less energy than a 50W MR16
- Higher flux than available LED MR16 lamps
- Provides the efficiency, output and lifetime only an integrated LED solution can offer
- No need to replace halogen lamps and bi-pin sockets



### CorePro LED Track

Catalog Number	UPC Code	Model Number	Product Description	Compliance	Case/Pallet Qty	Distribution Center
<b>CorePro Track LED Track Heads</b>						
● LT08RNF830WHVA	190096041763	912400541984	900lm 8CRI 3000K Narrow Flood Beam White Finish	Energy Star	1/224	TN
● LT08RWF830BKVA	190096041923	912400542001	900lm 8CRI 3000K Wide Flood Beam Black Finish	Energy Star	1/224	TN, PA
■ LT08RWF830WHVA	190096041916	912400541999	900lm 8CRI 3000K Wide Flood Beam White Finish	Energy Star	1/224	TN, PA

- Stock Ready (returnable)
- Design Ready (non-returnable)



9030NWH



9038NWH

## Gimbal Rings

Clean design for a **close fit**

Features a minimalistic form designed with LED lamps in mind, helping keep the customer's focus where you want it to be.



### Why choose Gimbal Rings?

- Designed with minimalistic form to create a close fit with LED lamps
- Miniaturized detailed yoke and ring-shaped lampholder for a clean appearance
- Front relamping for easy maintenance
- Units adjust horizontally up to 350° and vertically up to 90°
- Molded polycarbonate bodies allow for scratch free handling during installation and relamping

### Gimbal Rings

Catalog Number	UPC Code	Model Number	Product Description	Compliance	Case/Pallet Qty	Distribution Center
Gimbal Ring Track Heads						
● 9030NWH	662057905914	912400528335	PAR30 White Finish	-	1/224	PA
● 9038NBK	662057905938	912400528336	PAR38 Black Finish	-	1/192	PA
● 9038NWH	662057905945	912400528337	PAR38 White Finish	-	1/192	PA

- Stock Ready (returnable)
- Design Ready (non-returnable)



# SpotLED

SpotLED is a high brightness LED track solution in a multi-optic LED design



## Why choose SpotLED?

- Luminaires range in size, with multiple distributions, lumen packages, color temperatures, beam spreads and finishes
- Trailing edge (ELV) dimming



## SpotLED

Catalog Number	UPC Code	Model Number	Product Description	Compliance	Case/Pallet Qty	Distribution Center
<b>SpotLED Track Heads</b>						
LLABS30RNF BK	662057651033	912400478788	600lm 80-85CRI 3000K Narrow Flood Beam Black Finish	Energy Star	1/320	Factory
LLAB030RFBKVA	662057955841	912401053054	1000lm 80-85CRI 3000K Flood Beam Black Finish	Energy Star	-	Factory
LLAB030RFWHVA	662057955810	912401053051	1000lm 80-85CRI 3000K Flood Beam White Finish	Energy Star	-	Factory
LLAB030RSWHVA	662057955650	912401053033	1000lm 80-85CRI 3000K Spot Beam White Finish	Energy Star	1/320	Factory
LLAB130RFBKVA	662057947037	912401052651	2000lm 80-85CRI 3000K Flood Beam Black Finish	Energy Star	-	Factory
LLAB130RFWHVA	662057946993	912401052648	2000lm 80-85CRI 3000K Flood Beam White Finish	Energy Star	1/192	PA
LLAB130RNFWHVA	662057946900	912401052639	2000lm 80-85CRI 3000K Narrow Flood Beam White Finish	Energy Star	1/192	Factory
LLAB130RSWHVA	662057946825	912401052630	2000lm 80-85CRI 3000K Spot Beam White Finish	Energy Star	-	Factory
LLAB330RNF BKVA	662057958378	912401053209	3000lm 80-85CRI 3000K Narrow Flood Beam Black Finish	Energy Star	-	Factory
LLAB330RNFWHVA	662057958279	912401053206	3000lm 80-85CRI 3000K Narrow Flood Beam White Finish	Energy Star	1/144	PA
LLAB330RSBKVA	662057958217	912401053199	3000lm 80-85CRI 3000K Spot Beam Black Finish	Energy Star	-	Factory
LLAB330RSWHVA	662057958187	912401053196	3000lm 80-85CRI 3000K Spot Beam White Finish	Energy Star	1/192	PA
<b>SpotLED Track Accessories</b>						
23SN30BK	999999141194	912400468439	Small Snoot Black	-	1/648	PA
23SNT6BK	662057962153	912400468442	Medium/Large Snoot Black	-	40/720	PA
AL4HC	784197116064	912400461237	Hex Louver for Adjustable 6" & 7" Housing	-	150/3000	PA
LLABSAHBK	662057649191	912400471845	Small Accessory Holder Black	-	1/1440	PA
LLABSAHWH	662057887173	912400520528	Small Accessory Holder White	-	1/900	PA
LLAB1AHBK	662057654935	912400471841	Large Accessory Holder Black	-	1/2520	PA
LLAB1AHWH	662057657080	912400471842	Large Accessory Holder White	-	100/800	PA

- Stock Ready (returnable)
- Design Ready (non-returnable)





# Track Head LED

The light you want  
at the budget you need



## Why choose Track Head LED?

- Provides the efficiency, output and lifetime only an integrated LED solution can offer
- Available in two lumen packages: 1100lm and 3000lm
- White and black finishes
- Lightolier adapter

### Track Head LED

Catalog Number	UPC Code	Model Number	Product Description	Compliance	Case/Pallet Qty	Distribution Center
<b>Track Heads with Lightolier Track Adapter</b>						
● TH10930NF1B	190096016495	912400535922	1100lm 90CRI 3000K Narrow Flood Beam 120V Black Finish	Energy Star	6/312	PA
● TH10930NF1W	190096016488	912400535921	1100lm 90CRI 3000K Narrow Flood Beam 120V White Finish	Energy Star	6/312	CA, TN, PA
■ TH10930S1B	190096016471	912400535920	1100lm 90CRI 3000K Spot Beam 120V Black Finish	Energy Star	6/312	CA
■ TH10930S1W	190096016464	912400535919	1100lm 90CRI 3000K Spot Beam 120V White Finish	Energy Star	6/312	PA
■ TH30930F1B	190096016518	912400535924	3000lm 90CRI 3000K Flood Beam 120V Black Finish	Energy Star	6/180	PA
■ TH30930F1W	190096016501	912400535923	3000lm 90CRI 3000K Flood Beam 120V White Finish	Energy Star	6/180	PA
■ TH30930NF1B	190096016532	912400535926	3000lm 90CRI 3000K Narrow Flood Beam 120V Black Finish	Energy Star	6/180	PA
■ TH30930NF1W	190096016525	912400535925	3000lm 90CRI 3000K Narrow Flood Beam 120V White Finish	Energy Star	6/180	PA
<b>Track Heads with Juno Track Adapter</b>						
■ THJ10930NF1B	190096017225	912400543511	1100lm 90CRI 3000K Narrow Flood Beam 120V Black Finish	Energy Star	6/312	CA
■ THJ10930NF1W	190096017218	912400543510	1100lm 90CRI 3000K Narrow Flood Beam 120V White Finish	Energy Star	6/312	TN
■ THJ10930S1B	190096017201	912400543509	1100lm 90CRI 3000K Spot Beam 120V Black Finish	Energy Star	6/312	CA
■ THJ10930S1W	190096017195	912400543508	1100lm 90CRI 3000K Spot Beam 120V White Finish	Energy Star	6/312	CA
■ THJ30930F1B	190096017249	912400543513	1100lm 90CRI 3000K Spot Beam 120V Black Finish	Energy Star	6/180	CA
■ THJ30930F1W	190096017232	912400543512	1100lm 90CRI 3000K Spot Beam 120V White Finish	Energy Star	6/180	CA
■ THJ30930NF1B	190096017263	912400543515	3000lm 90CRI 3000K Narrow Flood Beam 120V Black Finish	Energy Star	6/180	CA
■ THJ30930NF1W	190096017256	912400543514	3000lm 90CRI 3000K Narrow Flood Beam 120V White Finish	Energy Star	6/180	CA

● Stock Ready (returnable)  
■ Design Ready (non-returnable)

# Track Systems

While continually improved over the years, our original track design from 1961 remains intact.

Every Lightolier track luminaire today will work on the very first piece of track we ever produced.



Advent



Basic



Radius

## Why choose Track Systems?

- Basic: Single circuit with capacity of 20 amps at 120V
- Advent: Double circuit with capacity of 40 amps at 120/240V
- Can be installed vertically or horizontal on walls
- Can be field cut
- Use with suspension beam or recessed housing



## Track Systems

Cat. No.	UPC Code	Model No.	Product Description	C.	C/P Qty	Dist. Center
Lytespan Basic Track						
6000NBK	784197594183	912400465046	2' Individual Track Black	-	1/500	PA
6000NWH	784197594190	912400465047	2' Individual Track White	-	1/500	PA
6001NBK	784197594206	912400465049	4' Individual Track Black	-	1/250	CA
6001NWH	784197594213	912400465050	4' Individual Track White	-	1/250	PA
6002NAL	784197539801	912400465051	8' Individual Metallic Aluminum	-	1/250	Factory
6002NBK	784197594220	912400465052	8' Individual Track Black	-	1/250	PA
6002NWH	784197594237	912400465053	8' Individual Track White	-	1/250	TN, PA
6003NBK	784197594244	912400465055	8' Joiner Track Black	-	1/250	Factory
6003NWH	784197594251	912400465056	8' Joiner Track White	-	1/250	PA
6004NBK	784197594268	912400465058	4' Plain Track w/o Live End Black	-	1/250	TN
6004NWH	784197594275	912400465059	4' Plain Track w/o Live End White	-	1/250	PA
6004NAL	784197539771	912400465057	4' Plain Track w/o Live End Aluminum	-	1/250	Factory
6008NBK	784197594282	912400465064	8' Plain Track w/o Live End Black	-	1/250	TN, PA
6008NWH	784197594299	912400465065	8' Plain Track w/o Live End White	-	1/250	TN
6008NAL	784197539733	912400465063	8' Plain Track w/o Live End Aluminum	-	1/250	Factory

Cat. No.	UPC Code	Model No.	Product Description	C.	C/P Qty	Dist. Center
Lytespan Basic Track Accessories						
6046NBK	784197594541	912400465070	Power Extension Connector Black	-	30/720	PA
6046NWH	784197594558	912400465071	Power Extension Connector White	-	6/720	Factory
6048NAL	784197539757	912400465072	Live End Aluminum	-	30/720	Factory
6048NBK	784197594589	912400465073	Live End Black	-	30/720	TN, PA
6048NWH	784197594596	912400465074	Live End White	-	30/720	TN, PA
6049NAL	784197539474	912400465075	Mini Coupler Aluminum	-	30/720	Factory
6049NBK	784197594565	912400465076	Mini Coupler Black	-	30/720	TN
6049NWH	784197594572	912400465077	Mini Coupler White	-	30/720	TN, PA
6050NBK	784197594466	912400465079	"L" Connector Black	-	30/720	PA
6050NWH	784197594473	912400465080	"L" Connector White	-	30/720	PA
6051NBK	784197594480	912400465082	"T" Connector Black	-	30/720	PA
6051NWH	784197594497	912400465083	"T" Connector White	-	30/720	PA
6052NBK	784197594503	912400465085	"X" Connector Black	-	30/720	Factory
6054NBK	784197594329	912400465091	In-Line Connector Black	-	2/720	TN
6054NWH	784197594350	912400465092	In-Line Connector White	-	25/700	PA

- Stock Ready (returnable)
- Design Ready (non-returnable)

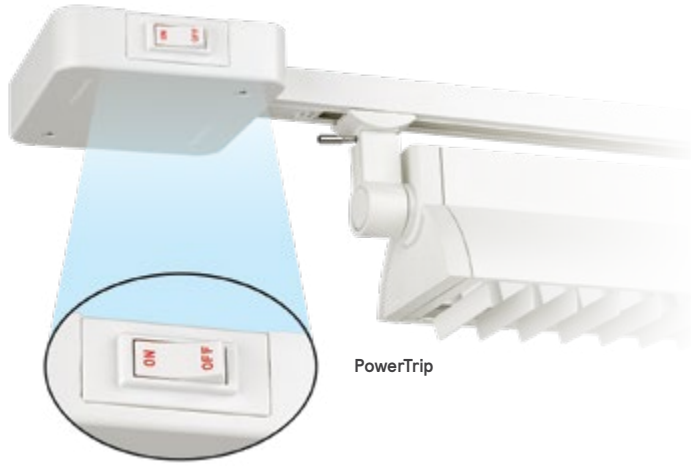

PowerTrip

# Track systems

(continued)

Cat. No.	UPC Code	Model No.	Product Description	C.	C/P Qty	Dist. Center
<b>Lytespan Basic &amp; Advent Track Accessories</b>						
● 6060BK	784197606015	912400462273	End Feed Canopy Black	-	100/1800	PA
■ 6060NAL	784197594749	912400465093	End Feed Canopy Aluminum	-	30/720	PA
● 6060WH	784197606008	912400462274	End Feed Canopy White	-	100/1800	PA
● 6061BK	784197606114	912400462275	Floating Canopy Black	-	50/900	PA
■ 6063BK	784197606312	912400462279	Floating Power Feed Black	-	30/720	Factory
■ 6063WH	784197606305	912400462280	Floating Power Feed White	-	30/720	Factory
■ 6087	784197020064	912400460361	Regressed Edge Panel & T Bar Clips (9Clip/Box)	-	30/720	Factory
■ 6089	784197608903	912400460363	Regressed Edge Panel & Slotted Grid Runner Clips (9Clip/Box)	-	30/720	PA
<b>Lytespan Advent Track</b>						
■ 6101NBK	784197572860	912400465098	4' Individual Track Black	-	1/250	PA
■ 6101NWH	784197572877	912400465099	4' Individual Track White	-	1/250	Factory
■ 6102NBK	784197572891	912400465102	8' Individual Track Black	-	1/250	Factory
■ 6103NBK	784197572921	912400465105	8' Joiner Track Black	-	1/250	Factory
■ 6104NBK	784197572952	912400465108	4' Track w/o Live End Black	-	1/250	Factory
■ 6104NWH	784197572969	912400465109	4' Track w/o Live End White	-	1/250	Factory
■ 6108NBK	784197572983	912400465111	8' Track w/o Live End Black	-	1/250	Factory
<b>Lytespan Advent Track Accessories</b>						
■ 6146NBK	784197573195	912400465120	Power Extension Connector Kit Black	-	30/720	Factory
■ 6146NWH	784197573201	912400465121	Power Extension Connector Kit White	-	10/720	Factory
■ 6148NBK	784197573621	912400465123	Live End Black	-	30/720	Factory
■ 6149NBK	784197573225	912400465126	Mini Coupler Black	-	30/720	PA
■ 6149NWH	784197573232	912400465127	Mini Coupler White	-	30/720	PA
■ 6150NBK	784197573089	912400465130	"L" Connector Black	-	30/720	Factory
■ 6150NWH	784197573096	912400465131	"L" Connector White	-	30/720	Factory
■ 6151NWH	784197573126	912400465134	"T" Connector White	-	30/720	Factory
■ 6153NWH	784197573171	912400465140	Variable Angle Connector White	-	6/150	Factory
■ 6154NBK	784197573058	912400465142	In-Line Connector Black	-	30/720	Factory
■ 6154NWH	784197573065	912400465143	In-Line Connector White	-	30/720	PA
<b>Lytespan Radius Track</b>						
■ 9102WH	784197910129	912400462746	2' Plain Track Matte White	-	-	Factory
■ 9104BK	784197910181	912400462747	4' Plain Track Matte Black	-	-	Factory
■ 9104WH	784197910167	912400462749	4' Plain Track Matte White	-	-	Factory
■ 9106WH	784197910204	912400462752	6' Plain Track Matte White	-	-	Factory
■ 9108BK	784197910266	912400462753	8' Plain Track Matte Black	-	-	Factory
■ 9108WH	784197910242	912400462755	8' Plain Track Matte White	-	-	Factory
<b>Lytespan Radius Track Accessories</b>						
■ 9189	784197910785	912400460489	T-Bar Clip for Square Edge Ceiling (set of 9)	-	1/8296	PA
■ 9163WH	784197910563	912400462777	Saddle Canopy Matte White	-	30/720	PA

Cat. No.	UPC Code	Model No.	Product Description	C.	C/P Qty	Dist. Center
<b>PowerTrip In-Line Connector</b>						
■ PLD120BK	784197531362	912400492648	PowerTrip New Design, Plug-In Breaker	-	1/140	Factory
■ PLD120WH	784197531379	912400492649	PowerTrip New Design, Plug-In Breaker	-	1/140	Factory
■ PLD360BK	784197531522	912400492654	PowerTrip New Design, Plug-In Breaker	-	1/140	Factory
■ PLD600BK	784197531577	912400492658	PowerTrip New Design, Plug-In Breaker	-	1/140	Factory
■ PLD600WH	784197531584	912400492659	PowerTrip New Design, Plug-In Breaker	-	1/140	Factory
■ PLD900BK	190096135929	912400492664	PowerTrip New Design, Plug-In Breaker	-	-	Factory
■ PLD900WH	190096135936	912400492665	PowerTrip New Design, Plug-In Breaker	-	-	Factory
<b>Lytespan Basic, Advent, Radius Track Accessories</b>						
■ 56417	784197295516	912400461051	Replacement Stem Hanger Assembly	-	1/720	Factory
■ 56451BK	784197564537	912400465032	Flush Mounting Clip for LyteSpan Track White	-	10/720	PA
■ 56451WH	784197564520	912400465033	Flush Mounting Clip for LyteSpan Track Black	-	10/720	Factory
■ 56491	784197296957	912400461060	Basic Track Dead End Cover	-	1/720	Factory
■ 6074WH	784197607401	912400462284	LyteSpot Extension Wand 18" White	-	1/150	PA
■ 7517	784197272258	912400460424	Splice Box/End Housing	-	10/200	PA
■ 7584	784197274269	912400460431	18" Stem Mounting Kit for Basic & Advent Track White	-	5/150	Factory
■ 7586	784197274320	912400460432	48" Stem Mounting Kit for Basic & Advent Track White	-	1/90	Factory
■ 7589BK	784197758905	912400462422	Track Attachment Fitting Black	-	1/336	Factory
■ 7596	784197274627	912400460434	Track/Surface Raceway Adapter for Basic Track	-	30/720	Factory
■ 7599	784197002305	912400460435	Track Pendant Adapter White	-	1/336	Factory
■ 7681	784197277116	912400460448	48" Stem Mounting Kit for Basic & Advent Track Black	-	1/90	PA
<b>Monopoint Accessories</b>						
■ 6170BK	784197515553	912400462332	Rectangular Monopoint, Matte Black	-	60/1200	PA
■ 6170WH	784197515546	912400462333	Rectangular Monopoint, Matte White	-	60/1200	PA
● 6190BK	784197619015	912400462344	Round Monopoint, Matte Black	-	60/2400	PA
■ 6190NAL	784197594770	912400465145	Round Monopoint, Matte Aluminum	-	60/1800	PA
● 6190WH	784197619022	912400462345	Round Monopoint, Matte White	-	60/2400	PA
<b>Lens Accessories</b>						
■ AF2AS	784197116170	912400461198	Asymmetrical Spread Lens 5"x55° Beam	-	1/720	Factory
■ AF2FR	784197477998	912400461199	Frosted Softening Lens, 2" Diameter	-	1/720	Factory
■ AF2SY	784197116163	912400461206	Spread Lens Symmetrical 55° Beam	-	1/720	CA
■ AF4AS	784197115975	912400461216	Spread Lens for ADJ 6" & 7" HSNB 5"x55°	-	1/720	Factory
<b>Hex Cell Louver Accessories</b>						
■ AL25HC	784197162696	912400462985	2.5" Hex Cell Louver	-	100/1200	PA
■ AL2HC	784197116118	912400461234	2" Hex Cell Louver	-	100/1200	PA
■ AL3HC	784197162931	912400461235	3.75" Hex Cell Louver	-	40/720	PA

● Stock Ready (returnable)  
■ Design Ready (non-returnable)

HCY14/HCY21



## HCY Sealed High Bay

Modern design and **energy savings**

A great new look with no more sacrifices and dependability you can trust.

### Why choose HCY Sealed High Bay?

- Field selectable color 4000K or 5000K
- Corrosion resistant black finish
- Heavy duty eyelet provided for connection to customer supplied suspension
- Accessory options of polycarbonate reflector and surface mount bracket
- Listed cULus for use in wet locations up to 50°C ambient, and IP65 rated



### HCY Sealed High Bay

Catalog Number	UPC Code	Model Number	Product Description	Compliance	Case/Pallet Qty	Distribution Center
<b>HCY Sealed High Bay</b>						
● HCY14L8CST-UN3-DIM	190096131099	911401855281	14,000lm, 80CRI, Color Select 4000K/5000K, 0-10V UNV, 120-347V	DLC Premium	1/45	TN
● HCY21L8CST-UN3-DIM	190096131105	911401855381	21,000lm, 80CRI, Color Select 4000K/5000K, 0-10V UNV, 120-347V	DLC Premium	1/45	TN
● HCY28L8CST-UN3-DIM	190096131112	911401855481	28,000lm, 80CRI, Color Select 4000K/5000K, 0-10V UNV, 120-347V	DLC Premium	1/30	TN
● HCY33L8CST-UN3-DIM	190096131129	911401855581	33,000lm, 80CRI, Color Select 4000K/5000K, 0-10V UNV, 120-347V	DLC Premium	1/30	TN
<b>Accessories</b>						
● HCY-PRSM	190096131150	911401855881	16" Clear Polycarbonate Reflector for HCY14L and HCY21L	-	10/80	TN
● HCY-PRLG	190096131167	911401855981	16" Clear Polycarbonate Reflector for HCY28L and HCY33L	-	10/40	TN
● HCY-SURFACE BKT SM	190096131174	911401856081	Surface Mount Bracket for HCY14L and HCY21L	-	20/720	TN
● HCY-SURFACE BKT LG	190096131181	911401856181	Surface Mount Bracket for HCY28L and HCY33L	-	20/480	TN

- Stock Ready (returnable)
- Design Ready (non-returnable)





## FCY Value High Bay

Update and upgrade for **real savings**

Low profile and durable design, efficiency and great price – FCX value high bay has it all.



### Why choose FCY Value High Bay?

- Die formed sheet metal housing and end plates
- Corrosion resistant gloss white paint after fabrication
- V-hooks and 48" chains supplied (set of 2) for installation
- Lumen maintenance up to 70% (L70) at 50,000 hours
- Access plate located on top of housing for easy wiring
- Field CCT selectable for 4000K or 5000K
- cULus listed for use in damp locations, -20°C to 45°C ambient

### FCY Value High Bay

Catalog Number	UPC Code	Model Number	Product Description	Compliance	Case/Pallet Qty	Distribution Center
<b>FCY Value High Bay</b>						
● FCY15L8CST-UNV-DIM	190096180653	912401590942	15,000lm, 80CRI, Color Select 4000K/5000K, 0-10V, UNV 120-347V	DLC Premium	1/27	GA*
● FCY22L8CST-UNV-DIM	190096180660	912401590943	24,000lm, 80CRI, Color Select 4000K/5000K, 0-10V, UNV 120-347V	DLC Premium	1/27	GA*
● FCY29L8CST-UNV-DIM	190096180677	912401590944	29,000lm, 80CRI, Color Select 4000K/5000K, 0-10V, UNV 120-347V	DLC Premium	1/24	GA*
<b>Accessories</b>						
● FCY-PENHGR	190096180738	912401590950	Pendant hanger accessory (adds 2.5" to height)	-	20/2100	Factory
● FCY-SBK	190096180714	912401590948	Surface bracket kit (adds 2.5" to height)	-	20/1680	Factory
● FCY-WG	190096180721	912401590949	Wire guard for FCY15L and FCY22L	-	10/600	Factory
● FCY-WG29	190096180745	912401590951	Wire guard for FCY29L	-	10/600	Factory
● MD360	734340586084	912400393731	Field installable 360° Motion detector (ON/OFF) occupancy sensor	-	20/720	TN

\* Will Call (pickup only)

- Stock Ready (returnable)
- Design Ready (non-returnable)





## FBX High Bay

**Compact and economical**  
with the latest technology

Save energy without straining your project budget or sacrificing light output.

### Why choose FBX High Bay?

- Versatile fixture ideal for a variety of spaces including warehouses, big box retail and school gymnasiums
- 12,000, 16,000 and 24,000 lm options
- All three configurations are serious energy savers with efficacy up to 138lm per watt
- Dimming is standard
- Simple installation



### FBX High Bay

Catalog Number	UPC Code	Model No.	Product Description	Compliance	Case/Pallet Qty	Dist. Center
<b>FBX High Bay</b>						
■ FBX12LL40-UNV	781370299927	912401261322	12,000lm, 80CRI, 4000K, UNV 120-277V	DLC Standard	1/40	PA
■ FBX12LL50-UNV	781370769079	912401264460	12,000lm, 80CRI, 5000K, UNV 120-277V	DLC Standard	1/40	Factory
● FBX16LL40-UNV	781370009946	912400389505	16,000lm, 80CRI, 4000K, UNV 120-277V	DLC Standard	1/36	TN
● FBX16LL50-UNV	781370754419	912401264353	16,000lm, 80CRI, 5000K, UNV 120-277V	DLC Standard	1/36	PA
■ FBX20LL50-UNV	781370721381	912401264117	20,000lm, 80CRI, 5000K, UNV 120-277V	DLC Standard	1/36	CA
■ FBX24LL40-480	784197054144	912401272102	24,000lm, 80CRI, 4000K, 480V	DLC Standard	-	Factory
● FBX24LL40-UNV	782343066874	912400389502	24,000lm, 80CRI, 4000K, UNV 120-277V	DLC Standard	1/36	TN
■ FBX24LL40-UNV-MD360	781370466206	912401265878	24,000lm, 80CRI, 4000K, UNV 120-277V, 360° Motion detector (ON/OFF)	DLC Standard	-	Factory
■ FBX24LL40-UNV-MD360PDD	784197166915	912401277109	24,000lm, 80CRI, 4000K, UNV 120-277V, 360° Motion detector (ON/DIM)	DLC Standard	1/35	CA
● FBX24LL50-UNV	781370646516	912401263725	24,000lm, 80CRI, 5000K, UNV 120-277V	DLC Standard	1/36	PA
■ FBX24LL50-UNV-MD360D	781370392406	912401267311	24,000lm, 80CRI, 5000K, UNV 120-277V, 360° Motion detector (ON/OFF)	DLC Standard	1/35	CA

- Stock Ready (returnable)
- Design Ready (non-returnable)



Wire Guard  
(accessory)

## FBX High Bay

(continued)

Catalog Number	UPC Code	Model No.	Product Description	Compliance	Case/Pallet Qty	Dist. Center
<b>Accessories</b>						
● FBX CHAIN KIT	782343142394	912401261309	54" Chains & V Brackets	-	50/1650	PA, CA
● FBX-GRIP10	781370375775	912401261677	10' Cables & V Brackets	-	100/2000	PA, CA
● FBX-GRIP5	781370375768	912401263727	5' Cables & V Brackets	-	1/396	PA, CA
● FBX-PENHGR	782343142790	912401261311	Pendant hanger (adds 3" to height)	-	1/210	TN, CA
■ FBX-SLCA-2N	784197228057	912401280917	Clear acrylic snap lens for FBX08L and FBX12L	-	1/1	TN
■ FBX-SLCA-2W	784197228071	912401280918	Clear acrylic snap lens for FBX16L, FBX20L and FBX24L	-	1/1	TN
■ FBX-SLCR-2W	784197228293	912401280921	Clear ribbed snap lens for FBX16L, FBX20L and FBX24L	-	1/1	PA
■ FBX-SLFA-2N	784197228019	912401280914	Frosted acrylic snap lens for FBX08L and FBX12L	-	1/1	TN
● FBX-SLFA-2W	784197228033	912401280915	Frosted acrylic snap lens for FBX16L, FBX20L and FBX24L	-	1/1	CA, TN, PA
■ FBX-SLFR-2W	784197228361	912401280924	Frosted ribbed snap lens for FBX16L, FBX20L and FBX24L	-	1/480	TN
■ WG-FBX-2N	782343143889	912401265067	Wire guard for FBX08L and FBX12L	DLC Standard	1/200	TN
● WG-FBX-2W	782343143872	912401262554	Wire guard for FBX16L, FBX20L and FBX24L	-	2/40	Factory
■ WG-FBX-4	782343143551	912401262184	Wire guard for FBX36L and FBX45L	-	1/64	PA
■ MD360	734340586084	912400393731	Field installable 360° Motion detector (ON/OFF) occupancy sensor	-	20/720	TN

- Stock Ready (returnable)
- Design Ready (non-returnable)





## FBY High Bay

### Versatility in form and function

Reliable and cost-friendly solutions for your big industrial or institutional spaces.

### Why choose FBY High Bay?

- Designed for a variety of applications, perfect for educational facilities, warehouses and retail outlets
- 12,000, 18,000, 24,000, 30,000, 48,000 or 60,000 lumen options
- A variety of useful mounting accessories
- Components are DesignLights Consortium qualified
- Dimming is standard
- Simple installation



### FBY High Bay

Catalog Number	UPC Code	Model No.	Product Description	Compliance	C/P Qty	Dist. Ctr.
<b>FBY High Bay</b>						
■ FBY12L835-UNV	-	912401495035	12,000lm, 80CRI, 3500K, UNV 120-277V	DLC Standard	-	Factory
■ FBY12L835-UNV-BSL10LST	-	912401496383	12,000lm, 80CRI, 3500K, UNV 120-277V, Emergency	DLC Standard	-	Factory
● FBY12L840-UNV	784197653125	912401494858	12,000lm, 80CRI, 4000K, UNV 120-277V	DLC Standard	1/80	TN
■ FBY12L840-UNV-LFA	-	912401496322	12,000lm, 80CRI, 4000K, UNV 120-277V, Factory Installed Frosted Acrylic Lens	DLC Standard	-	Factory
● FBY12L850-UNV	784197655891	912401495037	12,000lm, 80CRI, 5000K, UNV 120-277V	DLC Standard	1/80	TN
■ FBY12L850-UNV-LFA	-	912401496384	12,000lm, 80CRI, 5000K, UNV 120-277V, Factory Installed Frosted Acrylic Lens	DLC Standard	-	Factory
■ FBY18L840-UNV	784197653118	912401494857	18,000lm, 80CRI, 4000K, UNV 120-277V	DLC Standard	1/80	TN, CA
■ FBY18L840-UNV-BSL10LST	784197653187	912401494869	18,000lm, 80CRI, 4000K, UNV 120-277V, Emergency	DLC Standard	1/10	Factory
■ FBY18L840-UNV-LFA	-	912401496245	18,000lm, 80CRI, 4000K, UNV 120-277V, Factory Installed Frosted Acrylic Lens	DLC Standard	-	Factory
■ FBY18L840-UNV-MD360	-	912401496288	18,000lm, 80CRI, 4000K, UNV 120-277V, 360° Motion detector (ON/OFF)	DLC Standard	-	Factory
■ FBY18L840-UNV-WC6	784197665548	912401495687	18,000lm, 80CRI, 4000K, UNV 120-277V, Wired 6' 16/3 Cord	DLC Standard	-	Factory
● FBY18L850-UNV	784197655907	912401495039	18,000lm, 80CRI, 5000K, UNV 120-277V	DLC Standard	1/80	TN
■ FBY18L850-UNV-LFA	-	912401499011	18,000lm, 80CRI, 5000K, UNV 120-277V, Factory Installed Frosted Acrylic Lens	DLC Standard	-	Factory
■ FBY24L840-277-WP6	-	912401496343	24,000lm, 80CRI, 4000K, 277V, Wired 6' 16/3 Cord & NEMA Twist Lock Plug	DLC Standard	-	Factory

- Stock Ready (returnable)
- Design Ready (non-returnable)



## FBY High Bay

(continued)

Catalog Number	UPC Code	Model No.	Product Description	Compliance	C/P Qty	Dist. Ctr.
<b>FBY High Bay (continued)</b>						
■ FBY24L835-UNV-WC6/5	-	912401510475	24,000lm, 80CRI, 3500K, UNV 120-277V, Wired 6' 18/5 Cord		1/80	Factory
■ FBY24L840-277-WP6-MD360	-	912401496083	24,000lm, 80CRI, 4000K, 277V Driver, Wired 6' 16/3 Cord & NEMA Twist Lock Plug, Motion Detector	DLC Standard	-	Factory
● FBY24L840-UNV	784197653101	912401494856	24,000lm, 80CRI, 4000K, UNV 120-277V	DLC Standard	1/80	CA, TN, IL
■ FBY24L840-UNV-BSL10LST	784197653170	912401494854	24,000lm, 80CRI, 4000K, UNV 120-277V, Emergency	DLC Standard	-	Factory
■ FBY24L840-UNV-LFA	784197678722	912401495988	24,000lm, 80CRI, 4000K, UNV 120-277V, Factory Installed Frosted Acrylic Lens	DLC Standard	-	Factory
■ FBY24L840-UNV-MD360	784197653088	912401494853	24,000lm, 80CRI, 4000K, UNV 120-277V, Motion Detector	DLC Standard	-	Factory
■ FBY24L840-UNV-WC6	784197665562	912401495688	24,000lm, 80CRI, 4000K, UNV 120-277V, Wired 6' 16/3 Cord	DLC Standard	-	Factory
■ FBY24L840-UNV-WC6-MD360	-	912401496027	24,000lm, 80CRI, 4000K, UNV 120-277V, Wired 6' 16/3 Cord, 360° Motion detector (ON/OFF)	DLC Standard	-	Factory
● FBY24L850-UNV	784197655914	912401495041	24,000lm, 80CRI, 5000K, UNV 120-277V,	DLC Standard	1/80	TN
■ FBY24L850-UNV-LFA	-	912401496049	24,000lm, 80CRI, 5000K, UNV 120-277V, Factory Installed Frosted Acrylic Lens	DLC Standard	-	Factory
■ FBY24L850-UNV-WC6	-	912401510460	24,000lm, 80CRI, 5000K, UNV 120-277V, Wired 6' 16/3 Cord		1/80	Factory
■ FBY30L840-277-WP6-MD360	-	912401496081	30,000lm, 80CRI, 4000K, 277V, Wired 6' 16/3 Cord & NEMA Twist Lock, 360° Motion detector (ON/OFF)	DLC Standard	-	Factory
■ FBY30L840-UNV	784197653095	912401494855	30,000lm, 80CRI, 4000K, UNV 120-277V	DLC Standard	-	Factory
■ FBY30L840-UNV-BSL10LST-MD360	-	912401497289	30,000lm, 80CRI, 4000K, UNV 120-277V, Emergency, 360° Motion detector (ON/OFF)	DLC Standard	-	Factory
■ FBY30L840-UNV-LFA	-	912401497040	30,000lm, 80CRI, 4000K, UNV 120-277V, Factory Installed Frosted Acrylic Lens	DLC Standard	-	Factory
■ FBY30L840-UNV-MD360	-	912401496121	30,000lm, 80CRI, 4000K, UNV 120-277V, 360° Motion detector (ON/OFF)	DLC Standard	-	Factory
■ FBY30L840-UNV-WC6	784197680084	912401497405	30,000lm, 80CRI, 4000K, UNV 120-277V, Wired 6' 16/3 Cord	DLC Standard	-	Factory
■ FBY30L840-UNV-WC6-LFA	-	912401510374	30,000lm, 80CRI, 4000K, UNV 120-277V, Wired 6' 16/3 Cord, Factory Installed Frosted Acrylic Lens		6/6	Factory
■ FBY30L840-UNV-WC6-MD360	-	912401496076	30,000lm, 80CRI, 4000K, UNV 120-277V, Wired 6' 16/3 Cord, 360° Motion detector (ON/OFF)	DLC Standard	-	Factory
■ FBY30L850-UNV-LFA	-	912401497321	30,000lm, 80CRI, 5000K, UNV 120-277V, Factory Installed Frosted Acrylic Lens	DLC Standard	-	Factory
■ FBY30L850-UNV-WC6	-	912401510454	30,000lm, 80CRI, 5000K, UNV 120-277V, Wired 6' 16/3 Cord		1/80	Factory
■ FBY30L850-UNV-WC6-MD360	-	912401510473	30,000lm, 80CRI, 5000K, UNV 120-277V, Wired 6' 16/3 Cord, 360° Motion detector (ON/OFF)		1/21	Factory
■ FBY36L840-UNV	-	912401496843	36,000lm, 80CRI, 4000K, UNV 120-277V	DLC Standard	-	Factory
■ FBY36L840-UNV-MD360	-	828820102717	36,000lm, 80CRI, 4000K, UNV 120-277V, 360° Motion detector (ON/OFF)	DLC Standard	-	Factory
■ FBY36L850-UNV	-	912401510342	36,000lm, 80CRI, 5000K, UNV 120-277V		1/27	TN, CA
■ FBY48L840-UNV	-	912401496850	48,000lm, 80CRI, 4000K, UNV 120-277V	DLC Standard	-	Factory
■ FBY48L840-UNV-BSL320LV	-	912401496846	48,000lm, 80CRI, 4000K, UNV 120-277V, Emergency	DLC Standard	-	Factory
■ FBY48L840-UNV-MD360	-	912401496847	48,000lm, 80CRI, 4000K, UNV 120-277V, 360° Motion detector (ON/OFF)	DLC Standard	-	Factory
■ FBY60L840-UNV	-	912401496849	60,000lm, 80CRI, 4000K, UNV 120-277V	DLC Standard	-	Factory
■ FBY60L840-UNV-WC6	-	912401497217	60,000lm, 80CRI, 4000K, UNV 120-277V, Wired 6' 16/3 Cord	DLC Standard	-	Factory
■ FBY60L850-UNV	-	912401510339	60,000lm, 80CRI, 5000K, UNV 120-277V		1/27	Factory
<b>Accessories</b>						
● FBY-PENHGR	784197665036	912401495721	Pendant hanger (adds 3" to height)	-	1/960	TN, CA
● HNHS-VHOOK	784197658762	912401459117	54" Chains & V Brackets	-	1/1	TN, GA*
● HCH10-VHOOK	784197658731	912401459114	10' Cables & V Brackets	-	1/1	TN, GA*
● HCH5-VHOOK	784197658724	912401459113	5' Cables & V Brackets	-	1/1	TN, GA*

\* Will Call (pickup only)

- Stock Ready (returnable)
- Design Ready (non-returnable)



## FBD High Bay

A flexible fluorescent linear luminaire

Designed to meet the needs of today's industrial environment.



### Why choose FBD High Bay?

- 95% reflective specular aluminum reflectors maximize luminaire efficiency and control light distribution
- Steel housing with white polyester powder finish
- Electronic ballast(s)
- Rotating ring, locking type lampholders for T5HO and T8 lamps

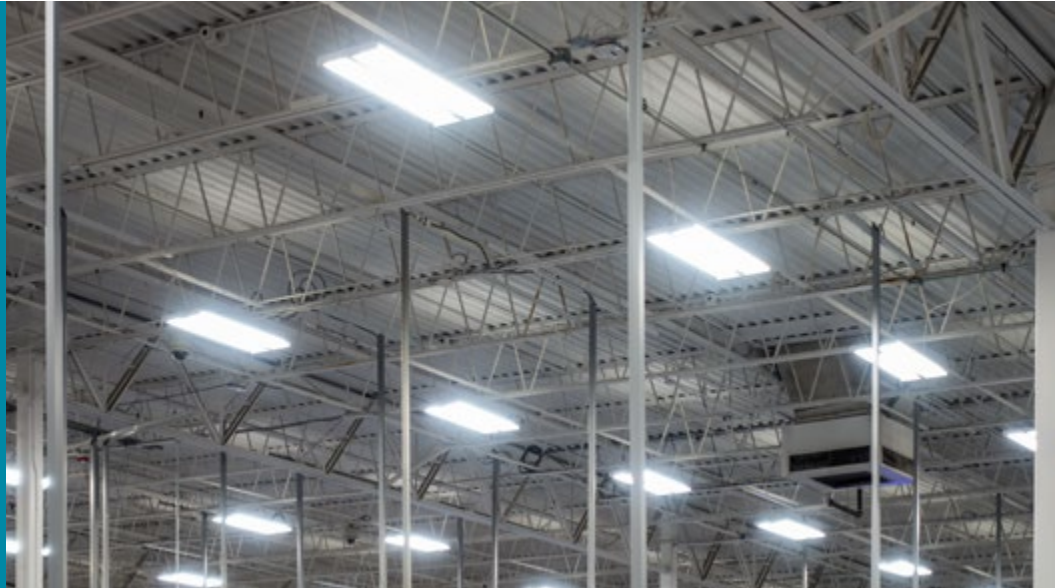

### FBD High Bay

Catalog Number	UPC Code	Model Number	Product Description	Compliance	Case/Pallet Qty	Dist. Ctr.
<b>FBD High Bay</b>						
FBD454HO-UNV-1/4-EB-2LS	782343199558	912400348321	4 Lamp, 54W T5HO, UNV 108-305V, Two Level Switching Option	-	1/36	PA
FBD632-UNV-1/42-EB	782343393406	912401025118	6 Lamp, 32W T8, UNV 108-305V, Two Level Switching Option	-	1/26	Factory
FBD654HO-UNV-1/42-EB	782343264003	912400348812	6 Lamp, 54W T5HO, UNV 108-305V, Two Level Switching Option	-	1/26	PA
<b>Accessories</b>						
FBD-6E-1W	782343829653	912401025192	Single Gasketed Door with Clear Acrylic Lens for 6 lamp units	-	-	Factory
WG-FBD4	782343829592	912401025189	Wire Guard for 4 lamp units	-	5/375	TN
MD360	734340586084	912400393731	Field installable 360° Motion detector (ON/OFF) occupancy sensor	-	20/720	TN

- Stock Ready (returnable)
- Design Ready (non-returnable)



## HBO High Bay

A general purpose high bay suitable for a host of applications

Applications including retail, education and industrial where uplight is required.



### Why choose HBO High Bay?

- Heavy wall, two piece die cast aluminum housing with white polyester powder finish
- Heavy gauge yoke provides positive mounting of reflector to ballast assembly and field adjustable light distribution patterns
- Injection molded 100% virgin acrylic prismatic reflector
- UL 1598 Listed suitable for damp location and 40°C ambient (55°C ambient for 400W)

### HBO High Bay

Catalog Number	UPC Code	Model Number	Product Description	Compliance	C/P Qty	Dist. Ctr.
<b>HBO High Bay</b>						
■ HBO250PMT-PSC-OR	734340394634	912400344291	250W, Pulse Start Metal Halide, 120/208/240/277V, Pulse Start CWA Ballast, Open Rated Socket	-	-	Factory
■ HBO320PMT-PSC-OR	734340394122	912400344287	320W, Pulse Start Metal Halide, 120/208/240/277V, Pulse Start CWA Ballast, Open Rated Socket	-	-	Factory
■ HBO10XMMT-OR	734340330984	912400343948	1000W, Metal Halide, 120/208/240/277V, Open Rated Socket	-	1/50	Factory
<b>Accessories</b>						
■ 16/17BE	782343957462	912400368341	16" Flat Tempered Glass Bottom Enclosure for A16 & A17 Aluminum High Bay Reflectors	-	1/260	Factory
■ A16	782343174609	912400348161	16" Aluminum High Bay Reflector for 450W Max	-	10/120	TN
■ HP27-3	782343601204	912400351763	Male Hook 3/4" NPT, 3' Usable Cord, Twist Lock Plug 277V AC 15 Amp, Nema L7-15P	-	-	Factory

## RBX High Bay

Familiar look and feel of a traditional high bay

Ideal for retail, industrial or commercial applications.

RBX/ARR16SL

RBX/ARR22L



### Why choose RBX High Bay?

- Die cast aluminum housing provides excellent thermal transfer to extend component life
- Textured polyester powder finish for excellent impact and corrosion resistance
- White acrylic reflector options available to provide up to 15% uplight
- 3/4" NPS top hub for easy hook or stem mounting



### RBX High Bay

Catalog Number	UPC Code	Model Number	Product Description	Compliance	Case/Pallet Qty	Distribution Center
<b>RBX High Bay</b>						
■ RBX10L840-UNV-WT	784197191511	912401283136	10,000lm, 80CRI, 4000K, UNV 120-277V, White Finish	-	1/16	PA
■ RBX15L840-UNV-WT	784197191504	912401282887	15,000lm, 80CRI, 4000K, UNV 120-277V, White Finish	-	1/16	PA
<b>Accessories</b>						
■ ARR16SL	784197247676	912401282408	Open 16" white acrylic reflector	-	1/1	Factory
■ ARR22L	784197253097	912401283128	Open 22" white acrylic standard reflector	-	1/1	CA

- Stock Ready (returnable)
- Design Ready (non-returnable)



# Day-Brite

## CFI

by Signify



## LBD/LBN Low Bay

**High efficiency general purpose industrial lighting**

For mounting height applications of 30' and below.



### Why choose LBD/LBN Low Bay?

- Heavy wall, one piece die cast aluminum housing with white polyester powder finish
- 3/4" threaded cast aluminum nut and hub for easy, positive mounting
- UL 1598 Listed suitable for wet location and 40°C ambient for all lamp wattages listed
- Corrosion resistant stainless steel latches

### LBD/LBN Low Bay

Catalog Number	UPC Code	Model No.	Product Description	Compliance	Case/Pallet Qty	Dist. Center
LBD/LBN Low Bay						
■ LBN400PMT-PSC-OR	782343589526	912401025134	400W, Pulse Start Metal Halide, 120/208/240/277V, Pulse Start CWA Ballast, Open Rated Socket	-	1/36	PA

- Stock Ready (returnable)
- Design Ready (non-returnable)





## FluxPanel Gen2

Uniform surface of light provides low glare, flicker free lighting at an affordable price.

### Why choose FluxPanel Gen2?

- DLC standard and premium options to assure performance and maximum ROI
- Tested TM21 prediction L70 up to 90,000 hrs and warranted for 5 years<sup>1</sup>
- Install the remote mount sensor accessory to capture maximum savings now and expand the network for add on sales and value in the future
- Flexible wiring options
- Available with factory installed BSL10LST self test 10W and BSL6LST self test 6W ...more lumen output for 1 watt less



### FluxPanel

Catalog Number	UPC Code	Model No.	Product Description	Compliance	Case/Pallet Qty	Dist. Center
<b>FluxPanel Gen2</b>						
1FPZ38B835-4-DS-UNV-DIM	190096180011	912401587017	1x4, 3800lm, 80CRI, 3500K, Smooth Diffuser, UNV 120-277V, 0-10V	DLC Standard	1/40	PA
1FPZ38B840-4-DS-UNV-DIM	190096180028	912401587018	1x4, 3800lm, 80CRI, 4000K, Smooth Diffuser, UNV 120-277V, 0-10V	DLC Standard	1/40	CA
2FPZ20L835-2-DS-UNV-DIM	190096180769	912401591598	2x2, 2000lm, 80CRI, 3500K, Smooth Diffuser, UNV 120-277V, 0-10V	DLC Premium	1/40	PA
2FPZ20L840-2-DS-UNV-DIM	190096180776	912401591599	2x2, 2000lm, 80CRI, 4000K, Smooth Diffuser, UNV 120-277V, 0-10V	DLC Premium	1/40	PA
2FPZ20L850-2-DS-UNV-DIM	190096181902	912401591705	2x2, 2000lm, 80CRI, 5000K, Smooth Diffuser, UNV 120-277V, 0-10V	DLC Premium	1/40	PA
2FPZ30L835-2-DS-UNV-DIM	190096180783	912401591601	2x2, 3000lm, 80CRI, 3500K, Smooth Diffuser, UNV 120-277V, 0-10V	DLC Premium	1/40	PA
2FPZ30L840-2-DS-UNV-DIM	190096180790	912401591602	2x2, 3000lm, 80CRI, 4000K, Smooth Diffuser, UNV 120-277V, 0-10V	DLC Premium	1/40	PA
2FPZ38B835-2-DS-UNV-DIM	190096180035	912401587019	2x2, 3800lm, 80CRI, 3500K, Smooth Diffuser, UNV 120-277V, 0-10V	DLC Standard	1/40	CA, TN, PA
2FPZ38B840-2-DS-UNV-DIM	190096180042	912401587020	2x2, 3800lm, 80CRI, 4000K, Smooth Diffuser, UNV 120-277V, 0-10V	DLC Standard	1/40	CA, TN, PA, IL
2FPZ30L835-4-DS-UNV-DIM	190096180806	912401591603	2x4, 3000lm, 80CRI, 3500K, Smooth Diffuser, UNV 120-277V, 0-10V	DLC Premium	1/20	PA
2FPZ30L840-4-DS-UNV-DIM	190096180813	912401591604	2x4, 3000lm, 80CRI, 4000K, Smooth Diffuser, UNV 120-277V, 0-10V	DLC Premium	1/20	PA
2FPZ30L850-4-DS-UNV-DIM	190096181919	912401591706	2x4, 3000lm, 80CRI, 5000K, Smooth Diffuser, UNV 120-277V, 0-10V	DLC Premium	1/20	PA
2FPZ38L835-4-DS-UNV-DIM	190096180837	912401591606	2x4, 3800lm, 80CRI, 3500K, Smooth Diffuser, UNV 120-277V, 0-10V	DLC Premium	1/20	PA
2FPZ38L840-4-DS-UNV-DIM	190096180820	912401591605	2x4, 3800lm, 80CRI, 4000K, Smooth Diffuser, UNV 120-277V, 0-10V	DLC Premium	1/20	PA
2FPZ42B835-4-DS-UNV-DIM	190096180066	912401587022	2x4, 4200lm, 80CRI, 3500K, Smooth Diffuser, UNV 120-277V, 0-10V	DLC Standard	1/20	CA, TN, PA
2FPZ42B840-4-DS-UNV-DIM	190096180073	912401587023	2x4, 4200lm, 80CRI, 4000K, Smooth Diffuser, UNV 120-277V, 0-10V	DLC Standard	1/20	CA, TN, PA, IL

1. Visit [signify.com/warranties](http://signify.com/warranties) for full warranty information.

- Stock Ready (returnable)
- Design Ready (non-returnable)





## Selectable Backlit Panel

Make the **easy selection**

Carry less stock with more options.



### Why choose Selectable Backlit Panel?

- 3 color temperature selections, 3 wattage choices, and 3 sizes available
- Numerous options for your customers, while keeping inventory levels and SKU count low
- Available for use in recessed, suspended and surface mount applications

#### Selectable Backlit Panel

Catalog Number	UPC Code	Model No.	Product Description	Compliance	Case/Pallet Qty	Dist. Center
Selectable Backlit Panel						
● 1SBP3040L8CS-4-UNV-DIM	190096130993	911401837681	1x4, Lumens Select, 80CRI, Color Select 3500K/4000K/5000K, UNV 120-277V, 0-10V (30W/34W/39W)	DLC Standard	4/24	CA, TN, PA, IL
● 2SBP3040L8CS-2-UNV-DIM	190096131006	911401837781	2x2, Lumens Select, 80CRI, Color Select 3500K/4000K/5000K, UNV 120-277V, 0-10V (30W/34W/39W)	DLC Standard	4/24	CA, TN, PA, IL, GA*
● 2SBP3550L8CS-4-UNV-DIM	190096131013	911401837881	2x2, Lumens Select, 80CRI, Color Select 3500K/4000K/5000K, UNV 120-277V, 0-10V (35W/38W/50W)	DLC Standard	4/12	CA, TN, PA, IL, GA*

\* Will Call (pickup only)

- Stock Ready (returnable)
- Design Ready (non-returnable)



## APX High Bay

**Durability and high performance for demanding environments**

For many areas requiring a sealed luminaire, such as laboratories, food processing, parking areas and other industrial applications.



### Why choose APX High Bay?

- Sealed, corrosion resistant luminaire for use in food processing or other industrial applications
- White, one-piece, molded fiberglass reinforced polyester housing with formed in place gasket
- Injection molded, high impact clear acrylic lens is standard
- Tamper-resistant, stainless steel, captive latches provide durability



### APX High Bay

Catalog Number	UPC Code	Model Number	Product Description	Compliance	Case/Pallet Qty	Distribution Center
APX High Bay						
■ APX24LL40-UNV	7841970566520	912401272307	24,000lm, 80CRI, 4000K, UNV 120-277V	DLC Standard	1/14	Factory



## LED Dock Light

**Rugged flexibility combined with incredible energy savings**

Designed to withstand the rigorous demands of shipping and receiving areas.



### Why choose LED Dock Light?

- Die cast aluminum head assembly
- All metal construction for extended life
- Flexible arm is infinitely adjustable and almost indestructible
- Painted "safety yellow" after fabrication for high visibility
- Shipped fully assembled with a replaceable LED module included

### LED Dock Light

Catalog Number	UPC Code	Model Number	Product Description	Compliance	Case/Pallet Qty	Dist. Center
LED Dock Light						
■ ID5L32-120	734340130249	912400342903	Light Engine with 5 Cool White LEDs, Stainless Steel Arm and Die Cast Head, 120V	-	1/16	Factory

## FluxStream Family



FSI  
(industrial)

**Real convenience for your operation's success**

Tough and dependable luminaires designed for ease of handling and flexibility.

### Why choose FluxStream?

- Compact design for tight spaces
- Frosted acrylic diffuser provides wide light distribution, superior glare control
- Diffuser and LED plate snap into place allowing tool-free access to LED boards and driver
- 2', 3', 4' and 8' tandem lengths available to accommodate many field applications
- Up to 100,000 hour predicted L70 LED lumen maintenance provides long service life to reduce maintenance costs



### FluxStream Family

Catalog Number	UPC Code	Model Number	Product Description	Compliance	Case/Pallet Qty	Dist. Center
<b>FluxStream LED Industrial</b>						
FSI440L840-UNV-DIM	784197245542	912401282281	4' Length, 4000lm, 80CRI, 4000K, UNV 120-277V, 0-10V	DLC Standard	1/40	TN
FSI440L840-UNV-DIM-EMLED	784197270575	912401283475	4' Length, 4000lm, 80CRI, 4000K, UNV 120-277V, 0-10V, Emergency	DLC Standard	1/40	Factory
FSI455L840-UNV-DIM	784197245566	912401283477	4' Length, 5500lm, 80CRI, 4000K, UNV 120-277V, 0-10V	DLC Standard	1/40	PA, IL
FSI455L840-UNV-DIM-EMLED	784197270711	912401283481	4' Length, 5500lm, 80CRI, 4000K, UNV 120-277V, 0-10V, Emergency	DLC Standard	1/40	TN
FSI470L840-UNV-DIM	784197245573	912401283483	4' Length, 7000lm, 80CRI, 4000K, UNV 120-277V, 0-10V	DLC Standard	1/40	Factory
FSI470L840-UNV-DIM-EMLED	784197270971	912401283487	4' Length, 7000lm, 80CRI, 4000K, UNV 120-277V, 0-10V, Emergency	DLC Standard	1/40	TN
FSI880L840-UNV-DIM	784197245580	912401283497	8' Length, 8000lm, 80CRI, 4000K, UNV 120-277V, 0-10V	DLC Standard	1/36	Factory
FSI880L840-UNV-DIM-EMLED	784197271138	912401283502	8' Length, 8000lm, 80CRI, 4000K, UNV 120-277V, 0-10V, Emergency	DLC Standard	1/36	TN
FSI8110L840-UNV-DIM	784197245597	912401283489	8' Length, 11000lm, 80CRI, 4000K, UNV 120-277V, 0-10V	DLC Standard	1/36	PA, IL
FSI8110L840-UNV-DIM-EMLED	784197271015	912401283491	8' Length, 11000lm, 80CRI, 4000K, UNV 120-277V, 0-10V, Emergency	DLC Standard	1/36	TN
FSI8140L840-UNV-DIM	784197245603	912401283493	8' Length, 14000lm, 80CRI, 4000K, UNV 120-277V, 0-10V	DLC Standard	1/36	Factory
FSI8140L840-UNV-DIM-EMLED	784197271060	912401283495	8' Length, 14000lm, 80CRI, 4000K, UNV 120-277V, 0-10V, Emergency	DLC Standard	1/36	Factory
<b>FluxStream LED Industrial Accessories</b>						
FSIWG4	784197295035	912401461922	Wire Guard 4' (order two for 8' models)	-	1/52	PA, IL

- Stock Ready (returnable)
- Design Ready (non-returnable)



FSS  
(Strip)

## FluxStream Family

(continued)

Catalog Number	UPC Code	Model Number	Product Description	Compliance	Case/Pallet Qty	Dist. Center
<b>FluxStream LED Strip</b>						
FSS220L835-UNV-DIM	784197270001	912401283411	2' Length, 2000lm, 80CRI, 3500K, UNV 120-277V, 0-10V	DLC Standard	1/80	TN
FSS220L840-UNV-DIM	784197245351	912401283410	2' Length, 2000lm, 80CRI, 4000K, UNV 120-277V, 0-10V	DLC Standard	1/80	TN
FSS220L850-UNV-DIM	-	912401502354	2' Length, 2,000lm, 80CRI, 5000K, UNV 120-277V, 0-10V	DLC Standard	-	Factory
FSS330L835-UNV-DIM	784197270018	912401283413	3' Length, 3000lm, 80CRI, 3500K, UNV 120-277V, 0-10V	DLC Standard	1/70	TN
FSS330L840-UNV-DIM	784197245375	912401283412	3' Length, 3000lm, 80CRI, 4000K, UNV 120-277V, 0-10V	DLC Standard	1/70	TN
FSS430L850-UNV-DIM	-	912401462710	4' Length, 3000lm, 80CRI, 5000K, UNV 120-277V, 0-10V	DLC Standard	-	Factory
FSS440L830-UNV-DIM	784197360948	912401462460	4' Length, 4000lm, 80CRI, 3000K, UNV 120-277V, 0-10V	DLC Standard	1/60	Factory
FSS440L835-UNV-DIM	784197270025	912401283415	4' Length, 4000lm, 80CRI, 3500K, UNV 120-277V, 0-10V	DLC Standard	1/60	CA, TN, PA
FSS440L835-UNV-DIM-EMLD	784197270056	912401283419	4' Length, 4000lm, 80CRI, 3500K, UNV 120-277V, 0-10V, Emergency	DLC Standard	1/40	TN
FSS440L835-UNV-DIM-SWZCS	-	912401607470	Fluxstream Strip, 4', 4000lm, 3500K, Interact Pro scalable	DLC Standard	1/70	Factory
FSS440L835-UNV-SDIM	784197270063	912401283421	4' Length, 4000lm, 80CRI, 3500K, UNV 120-277V, Step Dimming	DLC Standard	1/60	Factory
FSS440L835-UNV-SDIM-EMLD	784197270087	912401283423	4' Length, 4000lm, 80CRI, 3500K, UNV 120-277V, Step Dimming, Emergency	DLC Standard	1/40	TN
FSS440L840-UNV-DIM	784197245382	912401283414	4' Length, 4000lm, 80CRI, 4000K, UNV 120-277V, 0-10V	DLC Standard	1/60	CA, TN, PA, IL
FSS440L840-UNV-DIM-EMLD	784197251109	912401283418	4' Length, 4000lm, 80CRI, 4000K, UNV 120-277V, 0-10V, Emergency	DLC Standard	1/40	TN
FSS440L840-UNV-DIM-SWZCS	-	912401607471	Fluxstream Strip, 4', 4000lm, 4000K, Interact Pro scalable	DLC Standard	1/70	Factory
FSS440L840-UNV-SDIM	784197270070	912401283422	4' Length, 4000lm, 80CRI, 4000K, UNV 120-277V, Step Dimming	DLC Standard	1/60	TN
FSS440L840-UNV-SDIM-EMLD	784197270094	912401283424	4' Length, 4000lm, 80CRI, 4000K, UNV 120-277V, Step Dimming, Emergency	DLC Standard	1/40	TN
FSS440L850-UNV-DIM	784197360764	912401462451	4' Length, 4000lm, 80CRI, 5000K, UNV 120-277V, 0-10V	DLC Standard	-	Factory
FSS440L850-UNV-DIM-SWZCS	-	912401607472	Fluxstream Strip, 4', 4000lm, 5000K, Interact Pro scalable	DLC Standard	1/70	Factory
FSS455L835-UNV-DIM	784197270100	912401283426	4' Length, 5500lm, 80CRI, 3500K, UNV 120-277V, 0-10V	DLC Standard	1/60	CA, TN, PA
FSS455L840-UNV-DIM	784197245405	912401283425	4' Length, 5500lm, 80CRI, 4000K, UNV 120-277V, 0-10V	DLC Standard	1/60	TN, PA, IL
FSS455L850-UNV-DIM	784197375164	912401493099	4' Length, 5500lm, 80CRI, 5000K, UNV 120-277V, 0-10V	DLC Standard	-	Factory
FSS470L840-UNV-DIM	784197245412	912401283431	4' Length, 7000lm, 80CRI, 4000K, UNV 120-277V, 0-10V	DLC Standard	1/60	TN
FSS810L835-UNV-DIM	784197270254	912401283438	8' Length, 11000lm, 80CRI, 3500K, UNV 120-277V, 0-10V	DLC Standard	1/70	Factory
FSS810L835-UNV-DIM-EMLD	784197270278	912401283440	8' Length, 11000lm, 80CRI, 3500K, UNV 120-277V, 0-10V, Emergency	DLC Standard	1/36	TN
FSS810L840-UNV-DIM	784197245436	912401283437	8' Length, 11000lm, 80CRI, 4000K, UNV 120-277V, 0-10V	DLC Standard	1/70	PA, CA
FSS810L840-UNV-DIM-EMLD	784197270261	912401283439	8' Length, 11000lm, 80CRI, 4000K, UNV 120-277V, 0-10V, Emergency	DLC Standard	1/36	Factory
FSS810L850-UNV-DIM	784197140094	912401502098	8' Length, 11000lm, 80CRI, 5000K, UNV 120-277V, 0-10V	DLC Standard	-	Factory
FSS860L840-UNV-DIM	-	912401502152	8' Length, 6000lm, 80CRI, 4000K, UNV 120-277V, 0-10V	DLC Standard	-	Factory
FSS860L850-UNV-DIM	-	912401501722	8' Length, 6000lm, 80CRI, 5000K, UNV 120-277V, 0-10V	DLC Standard	-	Factory
FSS880L835-UNV-DIM	784197270308	912401283446	8' Length, 8000lm, 80CRI, 3500K, UNV 120-277V, 0-10V	DLC Standard	1/70	PA, CA
FSS880L835-UNV-DIM-EMLD	784197270346	912401283450	8' Length, 8000lm, 80CRI, 3500K, UNV 120-277V, 0-10V, Emergency	DLC Standard	1/36	Factory
FSS880L840-UNV-DIM	784197245429	912401283445	8' Length, 8000lm, 80CRI, 4000K, UNV 120-277V, 0-10V	DLC Standard	1/70	CA, TN, PA, IL
FSS880L840-UNV-DIM-EMLD	784197270339	912401283449	8' Length, 8000lm, 80CRI, 4000K, UNV 120-277V, 0-10V, Emergency	DLC Standard	1/36	Factory
FSS880L850-UNV-DIM	784197360771	912401462452	8' Length, 8000lm, 80CRI, 5000K, UNV 120-277V, 0-10V	DLC Standard	-	Factory
<b>FluxStream LED Sealed Strip</b>						
FSX440L840-UNV	784197416102	912401501592	4' Length, 4000lm, 80CRI, 4000K, UNV 120-277V	DLC Standard	1/60	Factory
FSX460L840-UNV	784197426026	912401501667	4' Length, 6000lm, 80CRI, 4000K, UNV 120-277V	DLC Standard	1/60	Factory
<b>FluxStream LED Strip EZ</b>						
FSSEZ440L830-UNV	784197269999	912401283409	4' Length, 4000lm, 80CRI, 3000K, UNV 120-277V, Non-Dimming	DLC Standard	1/60	PA, CA
FSSEZ440L835-UNV	784197269982	912401283408	4' Length, 4000lm, 80CRI, 3500K, UNV 120-277V, Non-Dimming	DLC Standard	1/60	CA, TN, PA, IL
FSSEZ440L840-UNV	784197245344	912401283407	4' Length, 4000lm, 80CRI, 4000K, UNV 120-277V, Non-Dimming	DLC Standard	1/60	CA, TN, PA, IL, GA*
FSSEZ440L840-UNV-DIM	784197700171	912401499854	4' Length, 4000lm, 80CRI, 4000K, UNV 120-277V, 0-10V	DLC Standard	1/60	TN, CA
FSSEZ880L840-UNV	622252811052	912401494485	8' Length, 8000lm, 80CRI, 4000K, UNV 120-277V, Non-Dimming	DLC Standard	-	Factory
FSSEZ880L840-UNV-DIM	784197700188	912401499855	Fluxstream EZ 8', 8000 lm, 4000K, UNV 120-277V, 0-10V	DLC Standard	1/70	TN, CA

\* Will Call (pickup only)

- Stock Ready (returnable)
- Design Ready (non-returnable)





## FluxStream Family

(continued)

Catalog Number	UPC Code	Model Number	Product Description	Compliance	Case/Pallet Qty	Dist. Center
<b>FluxStream LED Strip Accessories</b>						
● FSSWG4	784197295028	912401461921	Wire Guard 4' (order two for 8' models)	DLC Standard	1/60	CA, TN, PA, IL
● FSTH	078197349707	912401462272	Sliding Hanger Bracket (set of two)	DLC Standard	4/900	TN, CA
<b>Fluxstream LED Wraparound</b>						
■ FSW230L835-UNV-DIM	784197263515	912401282853	2' Length, 3000lm, 80CRI, 3500K, UNV 120-277V, 0-10V	DLC Standard	1/80	TN
■ FSW230L840-UNV-DIM	784197245467	912401282854	2' Length, 3000lm, 80CRI, 4000K, UNV 120-277V, 0-10V	DLC Standard	1/80	Factory
■ FSW430L835-UNV-DIM-SWZCS	-	912401607474	Fluxstream Wrap, 4', 3000lm, 3500K, Interact Pro scalable	DLC Standard	1/40	Factory
■ FSW430L840-UNV-DIM-SWZCS	-	912401607475	Fluxstream Wrap, 4', 3000lm, 4000K, Interact Pro scalable	DLC Standard	1/40	Factory
● FSW440L835-UNV-DIM	784197263485	912401282849	4' Length, 4000lm, 80CRI, 3500K, UNV 120-277V, 0-10V	DLC Standard	1/40	PA
■ FSW440L835-UNV-DIM-SWZCS	-	912401607476	Fluxstream Wrap, 4', 4000lm, 3500K, Interact Pro scalable	DLC Standard	1/40	Factory
● FSW440L840-UNV-DIM	784197245481	912401282277	4' Length, 4000lm, 80CRI, 4000K, UNV 120-277V, 0-10V	DLC Standard	1/40	PA, CA
■ FSW440L840-UNV-DIM-SWZCS	-	912401607477	Fluxstream Wrap, 4', 4000lm, 4000K, Interact Pro scalable	DLC Standard	1/40	Factory
■ FSW440L840-UNV-SDIM	784197263584	912401282866	4' Length, 4000lm, 80CRI, 4000K UNV 120-277V, Step Dimming	DLC Standard	1/40	TN
■ FSW455L835-UNV-DIM	784197263522	912401282855	4' Length, 5500lm, 80CRI, 3500K, UNV 120-277V, 0-10V	DLC Standard	1/40	Factory
■ FSW455L840-UNV-DIM	784197245498	912401282856	4' Length, 5500lm, 80CRI, 4000K, UNV 120-277V, 0-10V	DLC Standard	1/40	TN
■ FSW470L840-UNV-DIM	784197245504	912401282858	4' Length, 7000lm, 80CRI, 4000K, UNV 120-277V, 0-10V	DLC Standard	1/40	Factory
■ FSW880L835-UNV-DIM	784197263560	912401282863	8' Length, 8000lm, 80CRI, 3500K, UNV 120-277V, 0-10V	DLC Standard	1/36	TN
■ FSW880L840-UNV-DIM	784197245511	912401282864	8' Length, 8000lm, 80CRI, 4000K, UNV 120-277V, 0-10V	DLC Standard	1/36	Factory
■ FSW810L835-UNV-DIM	784197263546	912401282859	8' Length, 11000lm, 80CRI, 3500K, UNV 120-277V, 0-10V	DLC Standard	1/36	TN
■ FSW8110L840-UNV-DIM	784197245528	912401282860	8' Length, 11000lm, 80CRI, 4000K, UNV 120-277V, 0-10V	DLC Standard	1/36	TN
■ FSW8140L835-UNV-DIM	784197263553	912401282861	8' Length, 14000lm, 80CRI, 3500K, UNV 120-277V, 0-10V	DLC Standard	1/36	TN
■ FSW8140L840-UNV-DIM	784197245535	912401282862	8' Length, 14000lm, 80CRI, 4000K, UNV 120-277V, 0-10V	DLC Standard	1/36	Factory
<b>FluxStream LED Wraparound EZ</b>						
● FSWEZ440L830-UNV	784197263492	912401282850	4' Length, 4000lm, 80CRI, 3000K, UNV 120-277V, Non-Dimming	DLC Standard	1/40	Factory
● FSWEZ440L835-UNV	784197263508	912401282851	4' Length, 4000lm, 80CRI, 3500K, UNV 120-277V, Non-Dimming	DLC Standard	1/40	PA
● FSWEZ440L840-UNV	784197245450	912401282852	4' Length, 4000lm, 80CRI, 4000K, UNV 120-277V, Non-Dimming	DLC Standard	1/40	PA
<b>Fluxstream LED Wraparound Accessories</b>						
● FSWJ	784197349721	912401462274	Continuous row Joiner for Wraparound (one per joint required)	DLC Standard	8/440	TN
● DACH48	734340989724	912400347291	Adjustable 48" cable hanger kit (single)	-	100/2000	PA, CA
● DACH48-1-SC	734340989731	912400347292	Adjustable 48" cable hanger kit with white straight 18/3 cord (single)	-	1/1	PA
● DACH48-ID-SC	784197362096	912401454126	Adjustable 48" cable hanger kit with white straight 18/5 cord & dim leads (single)	-	1/1	PA, CA

- Stock Ready (returnable)
- Design Ready (non-returnable)







NWL  
(Wraparound)  
with field on/off  
occupancy sensor

## NWL Selectable Wraparound

Achieve a balance of performance and appeal

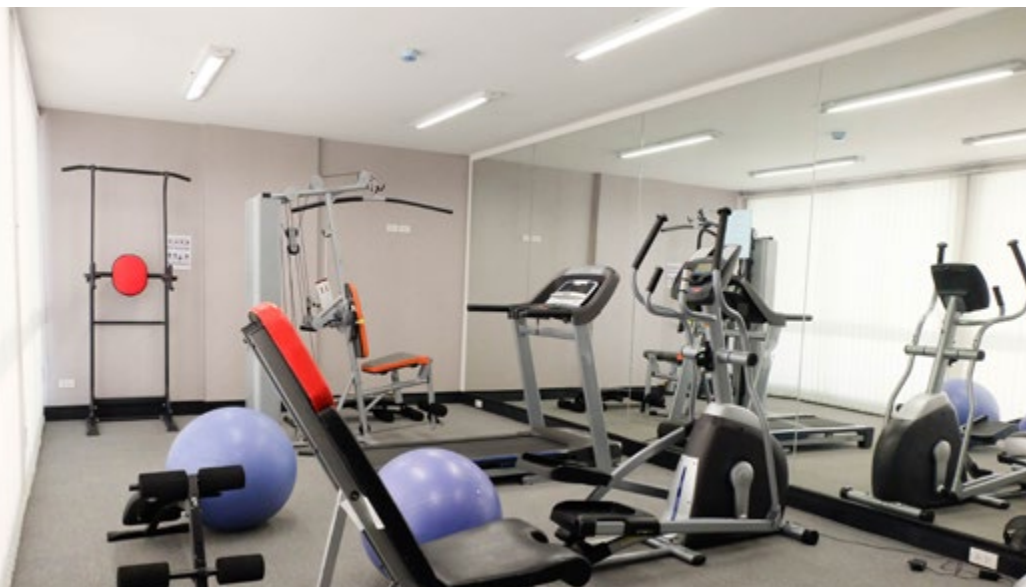

### Why choose NWL Selectable Wraparound?

- White polycarbonate housing for durability
- Frosted polycarbonate lens for even, low glare lighting
- Hardware for surface mounting included
- Field CCT selectable for 3000K, 3500K or 4000K
- cETLus listed to meet UL 1598 standards for -10°C to 35°C ambient. Suitable for damp locations

### NWL Selectable Wraparound

Catalog Number	UPC Code	Model Number	Product Description	Compliance	Case/Pallet Qty	Distribution Center
NWL Selectable Wraparound						
● NWL440L8CST-UNV-DIM-OCC	190096130917	911401803581	4' Length, 4000lm, 80CRI, Color Select 3000K-3500K-4000K, UNV 120-277V, 0-10V, Occupancy sensor	DLC Standard	4/32	TN, IL, GA*

\* Will Call (pickup only)



## OW Wraparound

### Functional & economical lift-and-shift wrap

Ideal for surface mount general illumination in light commercial and residential applications.

### Why choose OW Wraparound?

- Full steel end plates feature embosses for improved aesthetics
- 1% virgin acrylic lens hinges from either side
- Housing is multi-stage phosphate treated
- Multiple knockouts
- For surface or stem mounting



### OW Wraparound

Catalog Number	UPC Code	Model Number	Product Description	Compliance	Case/Pallet Qty	Distribution Center
<b>OW Wraparound</b>						
OWN217-UNV-1/2-EB	734340949810	912401025078	2' Length, Narrow Housing, 2 Lamp, 17W T8 (24"), UNV 120-277V, 1x2-Lamp Electronic Ballast	-	1/84	Factory
OWN232-UNV	734340608281	912400345515	4' Length, Narrow Housing, 2 Lamp, 32W T8 (48"), UNV 120-277V (lamp not included)	-	1/40	TN, PA
OWW432-UNV	734340608298	912400345516	4' Length, Wide Housing, 4 Lamp, 32W T8 (48"), UNV 120-277V (lamp not included)	-	1/30	TN
<b>OW Wraparound Accessories</b>						
OWL1448	782343403648	912400393874	Replacement Lens for Wide Housing	-	2/60	TN, PA, CA
OWL948-CS	782343403662	912400393804	Replacement Lens for Narrow Housing	-	1/40	PA

- Stock Ready (returnable)
- Design Ready (non-returnable)



OWL  
(Wraparound)

## OWL Wraparound

Achieve a balance of **performance and appeal**

Offers an optimal balance between LED performance and quality of light.



### Why choose OWL Wraparound?

- Tapered shape provides appearance of reduced depth
- Pattern 12 prismatic acrylic diffuser is specially designed to provide peak performance while minimizing pixilated glare
- Ceiling or suspended mounting
- Continuous row mountable

### OWL Wraparound

Catalog Number	UPC Code	Model Number	Product Description	Compliance	Case/Pallet Qty	Distribution Center
OWL Wraparound						
● OWL440L835-UNV	781370097219	912401261070	4' Length, 4,000lm, 80CRI, 3500K, UNV 120-277V, Non-Dimming	DLC Standard	1/40	CA, PA
● OWL440L840-UNV	781370049003	912401261072	4' Length, 4,000lm, 80CRI, 4000K, UNV 120-277V, Non-Dimming	DLC Standard	1/40	TN, PA
■ OWL450L835-UNV-DIM	781370097417	912401261074	4' Length, 5000lm, 80CRI, 3500K, UNV 120-277V, 0-10V	DLC Standard	1/40	Factory
■ OWL450L840-UNV-DIM	781370049010	912401261075	4' Length, 5000lm, 80CRI, 4000K, UNV 120-277V, 0-10V	DLC Standard	1/40	Factory
■ OWL470L840-UNV-DIM	781370049027	912401261077	4' Length, 7000lm, 80CRI, 4000K, UNV 120-277V, 0-10V	DLC Standard	-	Factory
■ OWL850L840-UNV-DIM	781370169015	912401261079	8' Length, 10000lm, 80CRI, 4000K, UNV 120-277V, 0-10V	DLC Standard	-	Factory

- Stock Ready (returnable)
- Design Ready (non-returnable)



# Day-Brite

## CFI

by Signify



## VTC Sealed Strip

**Rugged reliability**  
for efficient environments

Works hard and long to give you the durability you are looking for in challenging locations.

### Why choose VTC Sealed Strip?

- Grey one piece, molded polycarbonate body with no rusting, no oxidation, and no corrosion
- Standard lens is frosted
- Gasket provides tight seal between plastic lens and housing
- Stainless steel latches are standard
- Hanging V-hooks included (set of 2)
- cULus listed to meet UL 1598 standards for -10°C to 40°C ambient and suitable for wet locations



### VTC Sealed Strip

Catalog Number	UPC Code	Model Number	Product Description	Compliance	Case/Pallet Qty	Distribution Center
VTC Sealed Strip						
● VTC436L840-UNV	190096130283	911401738102	4' Length, 3600lm, 80CRI, 4000lm, UNV 120-277V (wet location)	-	6/36	CA, TN, PA, IL

- Stock Ready (returnable)
- Design Ready (non-returnable)



# Day-Brite

## CFI

by Signify

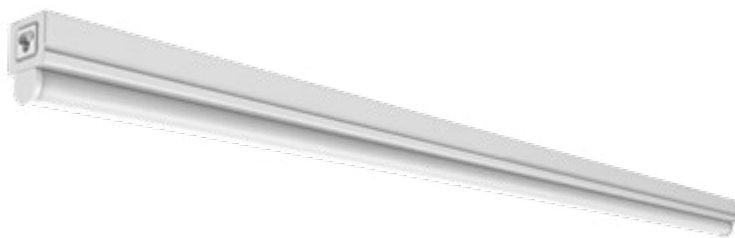

## SLS Linkable Strip

Get a team of lights  
working for you

Discover how continuous rows give you the quality of light needed in hard-working spaces.



### Why choose SLS Linkable Strip?

- Ideal for commercial or residential applications
- Available in 2' and 4' lengths
- High efficacy, more than 100 lumens per watt
- Frosted acrylic lens for even, low glare lighting
- Damp location listed
- 5-year limited warranty<sup>1</sup>

### SLS Linkable Strip

Catalog Number	UPC Code	Model Number	Product Description	Compliance	Case/Pallet Qty	Distribution Center
SLS Linkable Strip						
● SLS216L840-UNV	190096130191	911401737992	2' Length, 1600lm, 80CRI, 4000lm, UNV 120-277V	-	6/120	CA, TN, PA
● SLS432L840-UNV	190096130207	911401738002	4' Length, 3200lm, 80CRI, 4000lm, UNV 120-277V	-	6/120	CA, TN, PA

1. Visit [signify.com/warranties](http://signify.com/warranties) for full warranty information.

- Stock Ready (returnable)
- Design Ready (non-returnable)





## N Narrow Strip

### Small cross section strip

Budget friendly, yet highly efficient.

### Why choose N Narrow Strip?

- T8 luminaire available in 2', 3' and 4' lengths
- Heavy duty channel of code gauge die formed steel
- Suitable for unit, row, surface or suspension mounting
- cULus listed for direct mounting on low density ceilings and damp locations



### N Narrow Strip

Catalog Number	UPC Code	Model Number	Product Description	Compliance	Case/Pallet Qty	Distribution Center
N Narrow Strip						
■ N117-UNV-1/1-EB	734340776171	912400346346	2' Length, 1 Lamp, 17W T8, UNV 120-277V, Electronic Ballast	-	6/480	Factory
■ N125-UNV-1/1-EB	734340776188	912400346347	3' Length, 1 Lamp, 25W T8, UNV 120-277V, Electronic Ballast	-	8/200	PA
■ N132-UNV-1/1-EB	734340776195	912400346348	4' Length, 1 Lamp, 32W T8, UNV 120-277V, Electronic Ballast	-	1/200	Factory
■ TN132-UNV-1/2-EB	734340752571	912401025060	8' Length, 1 Lamp, 32W T8, UNV 120-277V, 1x2-Lamp Electronic Ballast	-	1/78	PA



## T Standard Strip

Economical, **functional**

A basic strip luminaire available in multiple lamp and reflector types.



### Why choose T Standard Strip?

- Convenient installation
- Suitable for unit, row, surface or suspension mounting
- Suitable for damp locations

### T Standard Strip

Catalog Number	UPC Code	Model Number	Product Description	Compliance	Case/Pallet Qty	Distribution Center
<b>T Standard Strip</b>						
● T232-UNV	734340608328	912400345519	4' Length, 2 Lamp, 32W T8, UNV 120-277V (lamp not included)	-	1/63	TN, PA
● TT232-UNV	734340608342	912400345521	4' Length, 2 Lamp, 32W T8, UNV 120-277V (lamp not included) (Tandem)	-	1/56	TN, PA
■ T259-UNV-1/2-EB	734340698688	912401025056	8' Length, 2 Lamp, 59W T8, UNV 120-277V, 1x2-Lamp Electronic Ballast	-	1/56	Factory
<b>T Standard Strip Accessories</b>						
● CG-4	782343296059	912400348992	Wire Guard for 4' T Strip / TH Strip	-	36/288	TN
■ CS-24	782343300244	912400349033	Straight Stem, 3/8" Trade Size, 24" Length	-	50/5000	TN
■ CS-48	782343300480	912400349037	Straight Stem, 3/8" Trade Size, 48" Length	-	25/1500	TN
■ CS-400	782343297803	912400349015	Rigid Canopy for 3/8" Straight Stem	-	50/2250	PA
■ CS-500	782343297902	912400349016	42° Top Swivel Canopy for 3/8" Straight Stem	-	50/400	TN
■ FL-123	782343299708	912400349026	5' Chain & "S" Hooks for Strips or Industrials	-	36/1728	PA

- Stock Ready (returnable)
- Design Ready (non-returnable)



## V3W Vaporlume

**Robust, yet highly efficient**

A specialized wet location, IP rated product designed for use in both indoor and outdoor environments.

### Why choose V3W Vaporlume?

- Ideally suited for use in refrigerated cold storage, industrial, parking garage, and canopy applications
- Acceptable for outdoor as well as indoor installations
- Can be surface mounted on ceilings or walls, or suspended via brackets, chain or cables
- Mounting brackets available, order separately
- NSF Certified option for Non-Food Zone/Splash Zone installations



### V3W Vaporlume

Catalog Number	UPC Code	Model Number	Product Description	Compliance	Case/Pallet Qty	Distribution Center
<b>V3W Vaporlume</b>						
■ V3W227L840-UNV-DIM	784197426781	912401501698	2' Length, 2700lm, 80CRI, 4000K, UNV 120-277V, 0-10V	DLC Standard	1/30	TN, PA, CA
■ V3W435L835-UNV-DIM	784197626358	912401460061	4' Length, 3500lm, 80CRI, 3500K, UNV 120-277V, 0-10V	DLC Standard	1/35	TN
■ V3W435L840-UNV-DIM	784197426460	912401501677	4' Length, 3500lm, 80CRI, 4000K, UNV 120-277V, 0-10V	DLC Standard	1/35	TN
■ V3W443L835-UNV-DIM	784197626365	912401460062	4' Length, 4300lm, 80CRI, 3500K, UNV 120-277V, 0-10V	DLC Standard	1/35	PA, CA
■ V3W443L840-UNV-DIM	784197426552	912401501686	4' Length, 4300lm, 80CRI, 4000K, UNV 120-277V, 0-10V	DLC Standard	1/35	Factory
■ V3W451L835-UNV-DIM	784197626372	912401460063	4' Length, 5100lm, 80CRI, 3500K, UNV 120-277V, 0-10V	DLC Standard	1/35	TN, PA, CA
● V3W451L840-UNV-DIM	784197426538	912401501684	4' Length, 5100lm, 80CRI, 4000K, UNV 120-277V, 0-10V	DLC Standard	1/35	TN, CA
■ V3W470L840-UNV-DIM	784197426514	912401501682	4' Length, 7000lm, 80CRI, 4000K, UNV 120-277V, 0-10V	DLC Standard	1/35	Factory
<b>V3W Vaporlume EZ</b>						
■ V3WEZ440L835-UNV	784197632175	912401457554	4' Length, 4000lm, 80CRI, 3500K, UNV 120-277V	DLC Standard	1/47	TN

- Stock Ready (returnable)
- Design Ready (non-returnable)







## DW/V2 Vaporlume

Highly specialized and designed for a variety of applications

A specialized IP rated luminaire designed for both indoor and outdoor environments



### Why choose DW/V2 Vaporlume?

- Ideally suited for use in refrigerated cold storage, industrial, parking garage and canopy applications
- Acceptable for outdoor as well as indoor installations
- Can be surface (wall/ceiling) or suspended mounted unless otherwise specified
- Wet location – areas of high humidity, water vapor, rain, incidental water spray or other non-corrosive or non-flammable liquid
- NSF Certified for Non-Food Zone installations

### DW/V2 Vaporlume

Catalog Number	UPC Code	Model Number	Product Description	Compliance	Case/Pallet Qty	Distribution Center
<b>DW/V2 Vaporlume</b>						
■ DWAE232-UNV-1/2-EB	734340608267	912400345513	2' Length, Wet Location, DR Acrylic Lens, Hub Installed Ends only, 2 Lamps, 32W T8, UNV 120-277V, 1x2-Lamp Electronic Ballast	-	1/35	Factory
■ TDWAE232-UNV-1/4-EB	734340608274	912400345514	2' Length, Wet Location, DR Acrylic Lens, Hub Installed Ends only, 2 Lamps, 32W T8, UNV 120-277V, 1x4-Lamp Electronic Ballast (Tandem)	-	1/30	PA
■ V2/DW-4ARL-CS	734340374667	912400344170	V2/DW-4ARL-CS	-	1/35	TN
■ V2/DW-8ARL	734340374704	912400344173	V2/DW-8ARL	-	1/30	Factory
<b>DW/V2 Vaporlume Accessories</b>						
● TBK	734340374599	912400344165	Stainless Steel Top Bracket Kit (pair of brackets plus hardware)	-	50/1000	PA, IL
● WBK	781370485887	912400370467	Stainless Steel Wraparound Bracket Kit (pair of brackets)	-	50/1200	PA

- Stock Ready (returnable)
- Design Ready (non-returnable)



## 1F/2F Industrial

A heavy duty luminaire with upright and crosswise shielding



### Why choose 1F/2F Industrial?

- Heavy duty channel of code gauge die formed steel
- Multiple knockouts for convenient installation
- Reflectors provide 10% uplight
- cULus listed for direct mounting on low density ceilings and damp locations



### 1F/2F Industrial

Catalog Number	UPC Code	Model Number	Product Description	Compliance	Case/Pallet Qty	Dist. Center
<b>1F/2F - 10% Uplight</b>						
1F232-PP-UNV-1/2-EB	782343241295	912400348691	4' Length, 2 Lamp, 32W T8, Painted Reflector, UNV 120-277V, 1x2-Lamp Electronic Ballast	-	1/20	PA
<b>1FD - 10% Uplight</b>						
1FD232-PP-UNV-1/2-EB	782343291238	912400348948	4' Length, 2 Lamp, 32W T8, Painted Reflector, UNV 120-277V, 1x2-Lamp Electronic Ballast	-	-	Factory
<b>Accessories</b>						
FL-173	782343296202	912400348997	Wire Guard for 1F Industrial, 2F Industrial, 1FD Industrial	-	25/300	TN



## IA/IS All-Purpose

**Industrial aesthetic,**  
all purpose application

An all purpose industrial luminaire with  
uplight at a budget friendly price.



### Why choose IA/IS All-Purpose?

- Reflectors feature reinforcing forms and are painted with high reflectance baked white enamel finish
- Multiple knockouts for convenient installation
- Heavy duty channel of code gauge die formed steel with baked white enamel finish
- cULus listed for damp locations

### IA/IS All-Purpose

Catalog Number	UPC Code	Model Number	Product Description	Compliance	Case/Pallet Qty	Dist. Center
<b>IA - Industrial with uplight</b>						
■ IA232-UNV-1/2-EB	734340608229	912400345509	4' Length, 2 Lamp, 32W T8, UNV 120-277V, 1x2-Lamp Electronic Ballast	-	1/33	TN
<b>TIA - Industrial with uplight</b>						
■ TIA232-UNV-1/4-EB	734340608236	912400345510	4' Length, 2 Lamp, 32W T8, UNV 120-277V, 1x4-Lamp Electronic Ballast (Tandem)	-	1/33	PA
<b>Accessories</b>						
● FKR-126	782343184103	912400348218	Chain hanger set with V-Hook (2)	-	20/1920	CA, TN, PA, GA*
■ FKR-173	782343259009	912400348780	4' Wire guard (use 2 for 8') for IA Industrial, IS Industrial	-	25/400	TN

\* Will Call (pickup only)

- Stock Ready (returnable)
- Design Ready (non-returnable)

## SlimLux

Saves time, energy and cost, all in one slim package



### Why choose SlimLux?

- Unique design allows you to mount directly to the NEMA G T-Grid
- Fast and convenient installation
- Quick connect mounting to the T-Grid speeds the work and minimizes disruption to existing spaces and returning workers
- The narrow profile has an extra wide bat wing distribution allowing you to distribute light evenly across the ceiling, with a 10% direct component to "activate" the space...and its occupants



### SlimLux

Catalog Number	UPC Code	Model Number	Product Description	Compliance	Case/Pallet Qty	Dist. Center
<b>Lightbars</b>						
SL1P02835NGW	190096130061	911401570851	2ft, 80CRI, 3500K, 90% Up / 10% Down, NEMA G 15/16" T-Grid, White Finish	DLC Standard	1/1	TN
SL1P02840NGW	190096130047	911401570651	2ft, 80CRI, 4000K, 90% Up / 10% Down, NEMA G 15/16" T-Grid, White Finish	DLC Standard	1/1	TN
SL1P04835NGW	190096130023	911401570451	4ft, 80CRI, 3500K, 90% Up / 10% Down, NEMA G 15/16" T-Grid, White Finish	DLC Standard	1/1	TN
SL1P04840NGW	190096130009	911401570251	4ft, 80CRI, 4000K, 90% Up / 10% Down, NEMA G 15/16" T-Grid, White Finish	DLC Standard	1/1	TN
<b>Driver Pods</b>						
SL02SG15LUNVDIM1	784197677206	912401495782	2ft, for 1 Lightbar, NEMA G T-Grid, 1500lm, UNV 120-277V, 0-10V	-	-	Factory
SL02SG15LUNVDIM1-BSL6LST	784197677213	912401495776	2ft, for 1 Lightbar, NEMA G T-Grid, 1500lm, UNV 120-277V, 0-10V, 6W Emergency	-	-	Factory
SL02QG15LUNVDIM1	784197677190	912401495781	2ft, for 4 Lightbars, NEMA G T-Grid, 1500lm, UNV 120-277V, 0-10V	-	-	Factory
SL02SG19LUNVDIM1	784197677176	912401495779	2ft, for 1 Lightbar, NEMA G T-Grid, 1900lm, UNV 120-277V, 0-10V	-	-	Factory
SL02SG19LUNVDIM1-BSL6LST	784197677183	912401495780	2ft, for 1 Lightbar, NEMA G T-Grid, 1900lm, UNV 120-277V, 0-10V, 6W Emergency	-	-	Factory
SL02QG19LUNVDIM1	784197677169	912401495778	2ft, for 4 Lightbars, NEMA G T-Grid, 1900lm, UNV 120-277V, 0-10V	-	-	Factory
SL04SG30LUNVDIM1	784197677145	912401495783	4ft, for 1 Lightbar, NEMA G T-Grid, 3000lm, UNV 120-277V, 0-10V	-	-	Factory
SL04SG30LUNVDIM1-BSL6LST	784197677152	912401495777	4ft, for 1 Lightbar, NEMA G T-Grid, 3000lm, UNV 120-277V, 0-10V, 6W Emergency	-	-	Factory
SL04QG30LUNVDIM1	784197677138	912401495774	4ft, for 4 Lightbars, NEMA G T-Grid, 3000lm, UNV 120-277V, 0-10V	-	-	Factory
SL04MG30LUNVDIM1	784197677121	912401495773	4ft, for 8 Lightbars, NEMA G T-Grid, 3000lm, UNV 120-277V, 0-10V	-	-	Factory
SL04SG38LUNVDIM1	784197656027	912401495771	4ft, for 1 Lightbar, NEMA G T-Grid, 3800lm, UNV 120-277V, 0-10V	-	1/108	TN
SL04SG38LUNVDIM1-BSL6LST	784197677114	912401495772	4ft, for 1 Lightbar, NEMA G T-Grid, 3800lm, UNV 120-277V, 0-10V, 6W Emergency	-	-	Factory
SL04QG38LUNVDIM1	784197656010	912401495770	4ft, for 4 Lightbars, NEMA G T-Grid, 3800lm, UNV 120-277V, 0-10V	-	1/108	TN
SL04MG38LUNVDIM1	784197656034	912401495769	4ft, for 8 Lightbars, NEMA G T-Grid, 3800lm, UNV 120-277V, 0-10V	-	1/108	TN

- Stock Ready (returnable)
- Design Ready (non-returnable)



## DuaLED

Rugged construction as the gen2 and clean aesthetic, blending into any environment.



### Why choose DuaLED?

- A companion surface mount luminaire that completes the look in those hard to access locations
- A range of lumen packages 4300-7300 to accommodate a range of ceiling heights and illumination requirements.
- CRI 80 at 3000, 3500, 4000 5000K
- DLC standard listed

### DuaLED

Catalog Number	UPC Code	Model No.	Product Description	Compliance	Case/Pallet Qty	Dist. Center
1DLG27L835-4-D-UNV-DIM	781370169817	912400395340	1x4, 2700lm, 80CRI, 3500K, Opal Diffuser, UNV 120-277V, 0-10V	DLC Standard	-	Factory
2DLG27L840-2-D-UNV-DIM	781370181307	912401044236	2x2, 2700lm, 80CRI, 4000K, Opal Diffuser, UNV 120-277V, 0-10V	DLC Standard	1/56	Factory
2DLG34L835-2-D-UNV-DIM	782343815472	912400359284	2x2, 3400lm, 80CRI, 3500K, Opal Diffuser, UNV 120-277V, 0-10V	DLC Standard	1/52	PA
2DLG34L840-2-D-UNV-DIM	782343751732	912400355077	2x2, 3400lm, 80CRI, 4000K, Opal Diffuser, UNV 120-277V, 0-10V	DLC Standard	-	Factory
2DLG38L835-2-D-UNV-DIM	782343882276	912400364135	2x2, 3800lm, 80CRI, 3500K, Opal Diffuser, UNV 120-277V, 0-10V	DLC Standard	1/68	Factory
2DLG38L840-2-D-UNV-DIM	782343781098	912400395153	2x2, 3800lm, 80CRI, 4000K, Opal Diffuser, UNV 120-277V, 0-10V	DLC Standard	-	Factory
2DLG43L835-4-D-UNV-DIM	782343815458	912400359283	2x4, 4300lm, 80CRI, 3500K, Opal Diffuser, UNV 120-277V, 0-10V	DLC Standard	1/1	Factory
2DLG43L840-4-D-UNV-DIM	782343814710	912400359224	2x4, 4300lm, 80CRI, 4000K, Opal Diffuser, UNV 120-277V, 0-10V	DLC Standard	1/1	Factory
2DLG44L835-2-D-UNV-DIM	782343873267	912400363564	2x2, 4400lm, 80CRI, 3500K, Opal Diffuser, UNV 120-277V, 0-10V	DLC Standard	-	Factory
2DLG44L840-2-D-UNV-DIM	782343743591	912400354598	2x2, 4400lm, 80CRI, 4000K, Opal Diffuser, UNV 120-277V, 0-10V	DLC Standard	1/64	Factory
2DLG49L835-4-D-UNV-DIM	782343841167	912400361222	2x4, 4900lm, 80CRI, 3500K, Opal Diffuser, UNV 120-277V, 0-10V	DLC Standard	1/24	PA
2DLG49L840-4-D-UNV-DIM	782343786635	912400357278	2x4, 4900lm, 80CRI, 4000K, Opal Diffuser, UNV 120-277V, 0-10V	DLC Standard	1/36	Factory
2DLG58L835-4-D-UNV-DIM	782343947043	912400367873	2x4, 5800lm, 80CRI, 3500K, Opal Diffuser, UNV 120-277V, 0-10V	DLC Standard	1/1	TN
2DLG58L840-4-D-UNV-DIM	782343496763	912400383682	2x4, 5800lm, 80CRI, 4000K, Opal Diffuser, UNV 120-277V, 0-10V	DLC Standard	-	Factory
2DLG73L835-4-D-UNV-DIM	782343820230	912400359615	2x4, 7300lm, 80CRI, 3500K, Opal Diffuser, UNV 120-277V, 0-10V	DLC Standard	-	Factory
2DLG73L840-4-D-UNV-DIM	782343786628	912400357277	2x4, 7300lm, 80CRI, 4000K, Opal Diffuser, UNV 120-277V, 0-10V	DLC Standard	1/38	Factory

- Stock Ready (returnable)
- Design Ready (non-returnable)

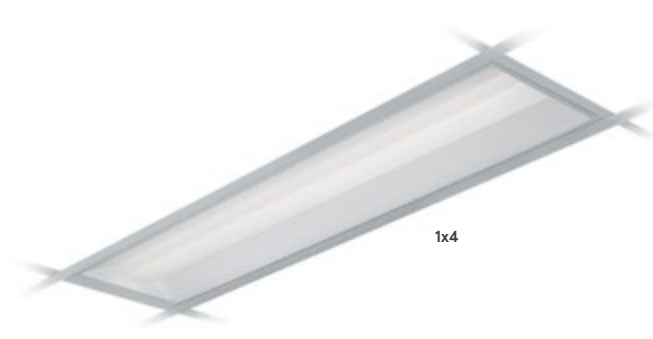

## ClearAppeal

Presenting a classic architectural profile with an end to end diffuser centered in a contoured metal body

### Why choose ClearAppeal?

- Internally ribbed diffuser provides an unique appearance with a smooth surface for easy maintenance
- Lambertian lighting distribution assures uniformity and visual comfort
- Glare free high angle light distribution provides even illumination of walls and ceilings
- Antimicrobial finish
- 5-year warranty<sup>1</sup>



### ClearAppeal

Catalog Number	UPC Code	Model No.	Product Description	Compliance	Case/Pallet Qty	Dist. Center
<b>ClearAppeal 1x4</b>						
1CAXG30L835-4-DS-UNV-DIM	784197669546	912401496467	1x4, 3000lm, 80CRI, 3500K, Smooth Diffuser, UNV 120-277V, 0-10V	DLC Standard	-	Factory
1CAXG30L840-4-DS-UNV-DIM	784197669621	912401496474	1x4, 3000lm, 80CRI, 4000K, Smooth Diffuser, UNV 120-277V, 0-10V	DLC Standard	1/33	TN
1CAXG38B835-4-DS-UNV-DIM	784197669522	912401496465	1x4, 3800lm, 80CRI, 3500K, Smooth Diffuser, UNV 120-277V, 0-10V	DLC Standard	-	Factory
1CAXG38B835-4-DS-UNV-DIM-BSL10LST	784197669942	912401496508	1x4, 3800lm, 80CRI, 3500K, Smooth Diffuser, UNV 120-277V, 0-10V, 10W Emergency	DLC Standard	-	Factory
1CAXG38B840-4-DS-UNV-DIM	784197669539	912401496466	1x4, 3800lm, 80CRI, 4000K, Smooth Diffuser, UNV 120-277V, 0-10V	DLC Standard	-	Factory
1CAXG38B840-4-DS-UNV-DIM-BSL10LST	784197669959	912401496509	1x4, 3800lm, 80CRI, 4000K, Smooth Diffuser, UNV 120-277V, 0-10V, 10W Emergency	DLC Standard	-	Factory
1CAXG38L835-4-DS-UNV-DIM	784197669553	912401496468	1x4, 3800lm, 80CRI, 3500K, Smooth Diffuser, UNV 120-277V, 0-10V	DLC Standard	-	Factory
1CAXG38L840-4-DS-UNV-DIM	784197669638	912401496475	1x4, 3800lm, 80CRI, 4000K, Smooth Diffuser, UNV 120-277V, 0-10V	DLC Standard	-	Factory
1CAXG45L835-4-DS-UNV-DIM	784197669560	912401496469	1x4, 4500lm, 80CRI, 3500K, Smooth Diffuser, UNV 120-277V, 0-10V	DLC Standard	-	Factory
1CAXG45L840-4-DS-UNV-DIM	784197669645	912401496476	1x4, 4500lm, 80CRI, 4000K, Smooth Diffuser, UNV 120-277V, 0-10V	DLC Standard	-	Factory

1. Visit [signify.com/warranties](http://signify.com/warranties) for full warranty information.

- Stock Ready (returnable)
- Design Ready (non-returnable)



## ClearAppeal

(continued)

Catalog Number	UPC Code	Model No.	Product Description	Compliance	Case/Pallet Qty	Dist. Center
<b>ClearAppeal 2x2</b>						
2CAXG30L835-2-DS-UNV-DIM	784197669683	912401496480	2x2, 3000lm, 80CRI, 3500K, Smooth Diffuser, UNV 120-277V, 0-10V	DLC Standard	-	Factory
2CAXG30L835-2-DS-UNV-DIM-CHIC	784197669690	912401496481	2x2, 3000lm, 80CRI, 3500K, Smooth Diffuser, UNV 120-277V, 0-10V, Chicago Plenum	DLC Standard	-	Factory
2CAXG30L840-2-DS-UNV-DIM	784197669737	912401496486	2x2, 3000lm, 80CRI, 4000K, Smooth Diffuser, UNV 120-277V, 0-10V	DLC Standard	1/44	TN
2CAXG38B835-2-DS-UNV-DIM	784197669652	912401496477	2x2, 3800lm, 80CRI, 3500K, Smooth Diffuser, UNV 120-277V, 0-10V	DLC Standard	-	Factory
2CAXG38B835-2-DS-UNV-DIM-CHIC	784197669669	912401496478	2x2, 3800lm, 80CRI, 3500K, Smooth Diffuser, UNV 120-277V, 0-10V, Chicago Plenum	DLC Standard	-	Factory
2CAXG38B840-2-DS-UNV-DIM	784197669676	912401496479	2x2, 3800lm, 80CRI, 4000K, Smooth Diffuser, UNV 120-277V, 0-10V	DLC Standard	-	Factory
2CAXG38L835-2-DS-UNV-DIM-BSL10LST	784197676575	912401497077	2x2, 3800lm, 80CRI, 3500K, Smooth Diffuser, UNV 120-277V, 0-10V, 10W Emergency	DLC Standard	-	Factory
2CAXG38L835-2-DS-UNV-DIM-CHIC	784197676568	912401497019	2x2, 3800lm, 80CRI, 3500K, Smooth Diffuser, UNV 120-277V, 0-10V, Chicago Plenum	DLC Standard	-	Factory
2CAXG38L840-2-DS-UNV-DIM	784197669744	912401496487	2x2, 3800lm, 80CRI, 4000K, Smooth Diffuser, UNV 120-277V, 0-10V	DLC Standard	1/44	TN
2CAXG45L835-2-DS-UNV-DIM	784197669713	912401496484	2x2, 4500lm, 80CRI, 3500K, Smooth Diffuser, UNV 120-277V, 0-10V	DLC Standard	-	Factory
2CAXG45L840-2-DS-UNV-DIM	784197669751	912401496488	2x2, 4500lm, 80CRI, 4000K, Smooth Diffuser, UNV 120-277V, 0-10V	DLC Standard	-	Factory
<b>ClearAppeal 2x4</b>						
2CAXG38L835-4-DS-UNV-DIM-CHIC	784197669805	912401496493	2x4, 3800lm, 80CRI, 3500K, Smooth Diffuser, UNV 120-277V, 0-10V, Chicago Plenum	DLC Standard	-	Factory
2CAXG42B835-4-DS-UNV-DIM-BSL10LST	784197670016	912401496516	2x4, 4200lm, 80CRI, 3500K, Smooth Diffuser, UNV 120-277V, 0-10V, 10W Emergency	DLC Standard	-	Factory
2CAXG42B835-4-DS-UNV-DIM-CHIC	784197669782	912401496491	2x4, 4200lm, 80CRI, 3500K, Smooth Diffuser, UNV 120-277V, 0-10V, Chicago Plenum	DLC Standard	-	Factory
2CAXG42B840-4-DS-UNV-DIM	784197669799	912401496492	2x4, 4200lm, 80CRI, 4000K, Smooth Diffuser, UNV 120-277V, 0-10V	DLC Premium	-	Factory
2CAXG42B840-4-DS-UNV-DIM-BSL10LST	784197670023	912401496517	2x4, 4200lm, 80CRI, 4000K, Smooth Diffuser, UNV 120-277V, 0-10V, 10W Emergency	DLC Premium	-	Factory
2CAXG43L835-4-DS-UNV-DIM	784197669812	912401496494	2x4, 4300lm, 80CRI, 3500K, Smooth Diffuser, UNV 120-277V, 0-10V	DLC Standard	-	Factory
2CAXG43L835-4-DS-UNV-DIM-BSL10LST	784197670030	912401496518	2x4, 4300lm, 80CRI, 3500K, Smooth Diffuser, UNV 120-277V, 0-10V, 10W Emergency	DLC Standard	-	Factory
2CAXG43L840-4-DS-UNV-DIM	784197669850	912401496498	2x4, 4300lm, 80CRI, 4000K, Smooth Diffuser, UNV 120-277V, 0-10V	DLC Standard	1/22	TN
2CAXG43L840-4-DS-UNV-DIM-BSL10LST	784197670054	912401496520	2x4, 4300lm, 80CRI, 4000K, Smooth Diffuser, UNV 120-277V, 0-10V, 10W Emergency	DLC Standard	-	Factory
2CAXG54L835-4-DS-UNV-DIM	784197669829	912401496495	2x4, 5400lm, 80CRI, 3500K, Smooth Diffuser, UNV 120-277V, 0-10V	DLC Standard	-	Factory
2CAXG54L835-4-DS-UNV-DIM-BSL10LST	784197670047	912401496519	2x4, 5400lm, 80CRI, 3500K, Smooth Diffuser, UNV 120-277V, 0-10V, 10W Emergency	DLC Standard	-	Factory
2CAXG54L835-4-DS-UNV-DIM-CHIC	784197669836	912401496496	2x4, 5400lm, 80CRI, 3500K, Smooth Diffuse, UNV 120-277V, 0-10V, Chicago Plenum	DLC Standard	-	Factory
2CAXG54L840-4-DS-UNV-DIM	784197669874	912401496501	2x4, 5400lm, 80CRI, 4000K, Smooth Diffuse, UNV 120-277V, 0-10V	DLC Standard	-	Factory
2CAXG54L840-4-DS-UNV-DIM-BSL10LST	784197670061	912401496521	2x4, 5400lm, 80CRI, 4000K, Smooth Diffuse, UNV 120-277V, 0-10V, 10W Emergency	DLC Standard	-	Factory

- Stock Ready (returnable)
- Design Ready (non-returnable)





2x2

## EvoGrid

Quiet obtrusive lighting for a variety of applications

EvoGrid LED delivers high efficacies (125–135lm/W) and superior visual comfort.

### Why choose EvoGrid?

- T Bar grids integral to the body for 15/16 and 9/16 grids
- Integral sensors, wired and wireless and POE control options
- Tunable options to support well-being and performance



### EvoGrid

Catalog Number	UPC Code	Model No.	Product Description	Compliance	C/P Qty	Dist. Center
<b>EvoGrid 2x2</b>						
● 2EVG30L835-2-D-UNV-DIM	784197028763	912401273519	2x2, 3000lm, 80CRI, 3500K, Opal Lens, UNV 120-277V, 0-10V	DLC Standard	1/52	TN, PA
■ 2EVG30L835-2-D-UNV-DIM-SWZCS	-	912401607429	2x2, 3000lm, 80CRI, 3500K, Opal Lens, UNV 120-277V, 0-10V, Interact Pro scalable	DLC Standard	1/20	Factory
● 2EVG30L840-2-D-UNV-DIM	784197061593	912401272954	2x2, 3000lm, 80CRI, 4000K, Opal Lens, UNV 120-277V, 0-10V	DLC Standard	1/52	TN, PA
■ 2EVG30L840-2-D-UNV-DIM-SWZCS	-	912401607430	2x2, 3000lm, 80CRI, 4000K, Opal Lens, UNV 120-277V, 0-10V, Interact Pro scalable	DLC Standard	1/20	Factory
● 2EVG38L835-2-D-UNV-DIM	784197028770	912401272141	2x2, 3800lm, 80CRI, 3500K, Opal Lens, UNV 120-277V, 0-10V	DLC Standard	1/52	TN, PA
■ 2EVG38L835-2-D-UNV-DIM-EMLED	784197028732	912401272133	2x2, 3800lm, 80CRI, 3500K, Opal Lens, UNV 120-277V, 0-10V, Emergency	DLC Standard	1/20	Factory
● 2EVG38L840-2-D-UNV-DIM	784197049133	912401272139	2x2, 3800lm, 80CRI, 4000K, Opal Lens, UNV 120-277V, 0-10V	DLC Standard	1/52	TN, PA
■ 2EVG38L840-2-D-UNV-DIM-EMLED	784197049188	912401272131	2x2, 3800lm, 80CRI, 4000K, Opal Lens, UNV 120-277V, 0-10V, Emergency	DLC Standard	1/20	PA, CA
● 2EVG45L835-2-D-UNV-DIM	784197028787	912401272138	2x2, 4500lm, 80CRI, 3500K, Opal Lens, UNV 120-277V, 0-10V	DLC Standard	1/52	PA
■ 2EVG45L835-2-D-UNV-DIM-EMLED	784197028749	912401272143	2x2, 4500lm, 80CRI, 3500K, Opal Lens, UNV 120-277V, 0-10V, Emergency	DLC Standard	1/20	Factory

- Stock Ready (returnable)
- Design Ready (non-returnable)





## EvoGrid

(continued)

Catalog Number	UPC Code	Model No.	Product Description	Compliance	C/P Qty	Dist. Center
<b>EvoGrid 2x4</b>						
● 2EVG38L835-4-D-UNV-DIM	784197028947	912401273072	2x4, 3800lm, 80CRI, 3500K, Opal Lens, UNV 120-277V, 0-10V	DLC Standard	1/26	TN
■ 2EVG38L835-4-D-UNV-DIM-EMLD	784197028848	912401273082	2x4, 3800lm, 80CRI, 3500K, Opal Lens, UNV 120-277V, 0-10V, Emergency	DLC Standard	-	Factory
■ 2EVG38L835-4-D-UNV-DIM-SWZCS	-	912401607432	2x4, 3800lm, 80CRI, 3500K, Opal Lens, UNV 120-277V, 0-10V, Interact Pro scalable	DLC Standard	1/10	Factory
● 2EVG38L840-4-D-UNV-DIM	784197049287	912401273077	2x4, 3800lm 80CRI, 4000K, Opal Lens, UNV 120-277V, 0-10V	DLC Standard	1/26	PA
■ 2EVG38L840-4-D-UNV-DIM-EMLD	784197049348	912401273087	2x4, 3800lm, 80CRI, 4000K, Opal Lens, UNV 120-277V, 0-10V, Emergency	DLC Standard	1/10	Factory
■ 2EVG38L840-4-D-UNV-DIM-SWZCS	-	912401607434	2x4, 3800lm, 80CRI, 4000K, Opal Lens, UNV 120-277V, 0-10V, Interact Pro scalable	DLC Standard	1/10	Factory
■ 2EVG38LH835-4-D-UNV-DIM	784197049201	912401273068	2x4, 3800lm, Hi-Efficacy, 80CRI, 3500K, Opal Lens, UNV 120-277V, 0-10V	DLC Premium	-	Factory
■ 2EVG38LH840-4-D-UNV-DIM	784197049249	912401273073	2x4, 3800lm, Hi-Efficacy, 80CRI, 4000K, Opal Lens, UNV 120-277V, 0-10V	DLC Premium	1/26	Factory
● 2EVG43L840-4-D-UNV-DIM	784197061302	912401272623	2x4, 4300lm, 80CRI, 4000K, Opal Lens, UNV 120-277V, 0-10V	DLC Standard	1/26	TN, PA
● 2EVG48L835-4-D-UNV-DIM	784197028961	912401272125	2x4, 4800lm, 80CRI, 3500K, Opal Lens, UNV 120-277V, 0-10V	DLC Standard	1/26	TN, PA
■ 2EVG48L835-4-D-UNV-DIM-EMLD	784197028862	912401272130	2x4, 4800lm, 80CRI, 3500K, Opal Lens, UNV 120-277V, 0-10V, Emergency	DLC Standard	1/10	Factory
● 2EVG48L840-4-D-UNV-DIM	784197049102	912401272128	2x4, 4800lm, 80CRI, 4000K, Opal Lens, UNV 120-277V, 0-10V	DLC Standard	1/26	TN, PA
■ 2EVG48LH840-4-D-UNV-DIM	784197049256	912401273074	2x4, 4800lm, Hi-Efficacy, 80CRI, 4000K, Opal Lens, UNV 120-277V, 0-10V	DLC Premium	1/26	CA
● 2EVG54L840-4-D-UNV-DIM	784197049119	912401272129	2x4, 5400lm, 80CRI, 4000K, Opal Lens, UNV 120-277V, 0-10V	DLC Standard	1/26	PA
■ 2EVG54L840-4-D-UNV-DIM-EMLD	784197049362	912401272135	2x4, 5400lm, 80CRI, 4000K, Opal Lens, UNV 120-277V, 0-10V, Emergency	DLC Standard	1/10	TN
■ 2EVG54LH840-4-D-UNV-DIM	784197049263	912401273075	2x4, 5400lm, Hi-Efficacy, 80CRI, 4000K, Opal Lens, UNV 120-277V, 0-10V	DLC Premium	1/26	PA
■ 2EVG74L835-4-D-UNV-DIM	784197028985	912401272127	2x4, 7400lm, 80CRI, 3500K, Opal Lens, UNV 120-277V, 0-10V	DLC Standard	1/26	Factory
■ 2EVG74L840-4-D-UNV-DIM	784197049126	912401272142	2x4, 7400lm, 80CRI, 4000K, Opal Lens, UNV 120-277V, 0-10V	DLC Standard	1/26	Factory
■ 2EVG74L840-4-D-UNV-DIM-EMLD	784197049379	912401272134	2x4, 7400lm, 80CRI, 4000K, Opal Lens, UNV 120-277V, 0-10V, Emergency	DLC Standard	1/10	TN
■ 2EVG74LH840-4-D-UNV-DIM	784197049270	912401273076	2x4, 7400lm, Hi-Efficacy, 80CRI, 4000K, Opal Lens, UNV 120-277V, 0-10V	DLC Premium	1/26	CA
<b>EvoGrid Accessories</b>						
● FMA14	734340775488	912400346341	1x4 "F" mounting frame for NEMA "F" ceiling	-	40/320	CA, TN, PA
● FMA22	734340775471	912400346340	2x2 "F" mounting frame for NEMA "F" ceiling	-	50/450	CA, GA*
● FMA24	734340775464	912400346339	2x4 "F" mounting frame for NEMA "F" ceiling	-	40/480	CA, TN, PA, GA*

\* Will Call (pickup only)

- Stock Ready (returnable)
- Design Ready (non-returnable)



## FluxGrid

FluxGrid family trusted solutions for core and performance applications

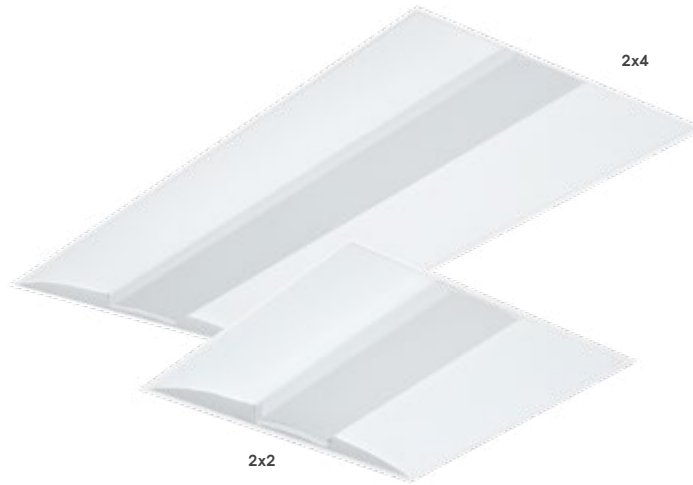

### Why choose FluxGrid?

- Offers just the right selection of service features and value
- Budget conscious specification product, offering premium visual comfort
- Popular diffuse lens types including a ribbed option round and flat
- Integrated control options at a competitive price
- 4 a full range of specification options such as hard ceiling compatibility



### FluxGrid

Catalog Number	UPC Code	Model No.	Product Description	Compliance	C/P Qty	Dist. Center
<b>FluxGrid 1x4 for Grid NEMA G 15/16" with Ribbed &amp; Smooth Diffuser</b>						
1FGG38L835-4-D-UNV-DIM	784197242176	912401282086	1x4, 3800lm, 80CRI, 3500K, Ribbed Diffuser, UNV 120-277V, 0-10V	DLC Standard	-	Factory
1FGG41B830-4-D-UNV-DIM	784197242206	912401282083	1x4, 4100lm, 80CRI, 3000K, Ribbed Diffuser, UNV 120-277V, 0-10V	DLC Standard	-	Factory
1FGG41B835-4-D-UNV-DIM	784197203634	912401281459	1x4, 4100lm, 80CRI, 3500K, Ribbed Diffuser, UNV 120-277V, 0-10V	DLC Standard	1/39	Factory
1FGG41B840-4-D-UNV-DIM	784197242282	912401282075	1x4, 4100lm, 80CRI, 4000K, Ribbed Diffuser, UNV 120-277V, 0-10V	DLC Standard	1/39	PA
1FGG41B840-4-DS-UNV-DIM	784197269159	912401283351	1x4, 4100lm, 80CRI, 4000K, Smooth Diffuser, UNV 120-277V, 0-10V	DLC Standard	1/39	TN
1FGG41B850-4-D-UNV-DIM	784197242114	912401282092	1x4, 4100lm, 80CRI, 5000K, Ribbed Diffuser, UNV 120-277V, 0-10V	DLC Standard	-	Factory
1FGG45L835-4-D-UNV-DIM	784197242169	912401282087	1x4, 4500lm, 80CRI, 3500K, Ribbed Diffuser, UNV 120-277V, 0-10V	DLC Standard	-	Factory
1FGG45L840-4-D-UNV-DIM	784197242138	912401282090	1x4, 4500lm, 80CRI, 4000K, Ribbed Diffuser, UNV 120-277V, 0-10V	DLC Standard	-	Factory
<b>FluxGrid 1x4 for Grid NEMA G 15/16" with Round Smooth Lens</b>						
1FGXG42B840-4-RS-UNV	-	912401608149	1x4, 4200lm, 80CRI, 4000K, Round Smooth Lens, UNV 120-277V, 0-10V	DLC Premium		
1FGXG38L840-4-RS-UNV-DIM-SWZCS	-	912401607956	1x4, 3800lm, 80CRI, 4000K, Round Smooth Lens, UNV 120-277V, 0-10V, Interact Pro scalable	DLC Premium	1/39	Factory
1FGXGH38L840-4-RS-UNV-DIM-SWZCS	-	912401608031	1x4, 3800lm, 80CRI, 4000K, Round Smooth Lens, UNV 120-277V, 0-10V, Interact Pro scalable	DLC Premium	1/39	Factory
<b>FluxGrid 2x2 for Grid NEMA G 15/16" with Ribbed &amp; Smooth Diffuser</b>						
2FGGH30L830-2-D-UNV-DIM-CHIC	784197375263	912401493048	2x2, 3000lm, 80CRI, 3000K, Ribbed Diffuser, UNV 120-277V, 0-10V, Chicago Plenum	DLC Standard	1/52	PA
2FGG30L835-2-D-UNV-DIM	784197291549	912401461796	2x2, 3000lm, 80CRI, 3500K, Ribbed Diffuser, UNV 120-277V, 0-10V	DLC Standard	1/52	TN
2FGG30L835-2-D-UNV-DIM-SWZDT	-	912401460375	2x2, 3000lm, 80CRI, 3500K, Ribbed Diffuser, UNV 120-277V, 0-10V, SpaceWise	DLC Standard	1/52	Factory
2FGG30L835-2-D-UNV-DIM-SWZCS	-	912401607446	2x2, 3000lm, 80CRI, 3500K, Ribbed Diffuser, UNV 120-277V, 0-10V, Interact Pro scalable	DLC Standard	1/20	Factory
2FGGH30L835-2-D-UNV-DIM-CHIC	784197364083	912401462544	2x2, 3000lm, 80CRI, 3500K, Ribbed Diffuser, UNV 120-277V, 0-10V, Chicago Plenum	DLC Standard	1/52	Factory
2FGG30L840-2-D-UNV-DIM-SWZDT	-	912401493083	2x2, 3000lm, 80CRI, 4000K, Ribbed Diffuser, UNV 120-277V, 0-10V, SpaceWise	DLC Standard	1/52	TN
2FGG30L840-2-D-UNV-DIM-SWZCS	-	912401607447	2x2, 3000lm, 80CRI, 4000K, Ribbed Diffuser, UNV 120-277V, 0-10V, Interact Pro scalable	DLC Standard	1/20	Factory

- Stock Ready (returnable)
- Design Ready (non-returnable)

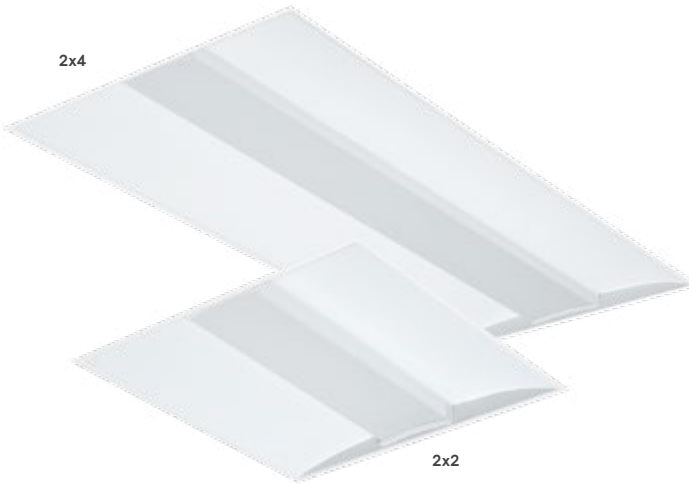

## FluxGrid

(continued)

Catalog Number	UPC Code	Model No.	Product Description	Compliance	C/P Qty	Dist. Center
<b>FluxGrid 2x2 for Grid NEMA G 15/16" with Ribbed &amp; Smooth Diffuser (continued)</b>						
● 2FGG38B830-2-D-UNV-DIM	784197242190	912401282084	2x2, 3800lm, 80CRI, 3000K, Ribbed Diffuser, UNV 120-277V, 0-10V	DLC Standard	1/52	TN
■ 2FGGH38B830-2-D-UNV-DIM-CHIC	784197374334	912401493050	2x2, 3800lm, 80CRI, 3000K, Ribbed Diffuser, UNV 120-277V, 0-10V, Chicago Plenum	DLC Standard	1/52	PA
● 2FGG38B835-2-D-UNV-DIM	784197203641	912401281466	2x2, 3800lm, 80CRI, 3500K, Ribbed Diffuser, UNV 120-277V, 0-10V	DLC Standard	1/52	TN, PA, GA*
● 2FGG38L835-2-D-UNV-DIM	784197242336	912401282070	2x2, 3800lm, 80CRI, 3500K, Ribbed Diffuser, UNV 120-277V, 0-10V	DLC Standard	1/52	TN, PA
■ 2FGG38L835-2-D-UNV-DIM-SWZDT	784197697884	912401502265	2x2, 3800lm, 80CRI, 3500K, Ribbed Diffuser, UNV 120-277V, 0-10V, SpaceWise	DLC Standard	1/52	PA
■ 2FGG38L835-2-D-UNV-DIM-SWZCS	-	912401607451	2x2, 3800lm, 80CRI, 3500K, Ribbed Diffuser, UNV 120-277V, 0-10V, Interact Pro scalable	DLC Standard	1/20	PA
■ 2FGG38B835-2-D-UNV-DIM-CHIC	784197395407	912401493042	2x2, 3800lm, 80CRI, 3500K, Ribbed Diffuser, UNV 120-277V, 0-10V, Chicago Plenum	DLC Standard	1/52	Factory
■ 2FGGH38B835-2-D-UNV-DIM-CHIC	784197374341	912401493051	2x2, 3800lm, 80CRI, 3500K, Ribbed Diffuser, UNV 120-277V, 0-10V, Chicago Plenum (Air Return)	DLC Standard	1/52	Factory
● 2FGG38B840-2-D-UNV-DIM	784197242268	912401282077	2x2, 3800lm, 80CRI, 4000K, Ribbed Diffuser, UNV 120-277V, 0-10V	DLC Standard	1/52	CA, TN, PA, GA*
● 2FGG38L840-2-D-UNV-DIM	784197242275	912401282076	2x2, 3800lm, 80CRI, 4000K, Ribbed Diffuser, UNV 120-277V, 0-10V	DLC Standard	1/52	PA
● 2FGG38B840-2-DS-UNV-DIM	784197269166	912401283352	2x2, 3800lm, 80CRI, 4000K, Smooth Diffuser, UNV 120-277V, 0-10V	DLC Standard	1/52	TN
■ 2FGG38L840-2-D-UNV-DIM-SWZDT	784197366988	912401493090	2x2, 3800lm, 80CRI, 4000K, Ribbed Diffuser, UNV 120-277V, 0-10V, SpaceWise	DLC Standard	1/52	PA
■ 2FGG38L840-2-D-UNV-DIM-SWZCS	784197702014	912401607333	2x2, 3800lm, 80CRI, 4000K, Ribbed Diffuser, UNV 120-277V, 0-10V, Interact Pro scalable	DLC Standard	1/20	PA
● 2FGG38B850-2-D-UNV-DIM	784197242107	912401282093	2x2, 3800lm, 80CRI, 5000K, Ribbed Diffuser, UNV 120-277V, 0-10V	DLC Standard	-	Factory
● 2FGG45L835-2-D-UNV-DIM	784197242329	912401282071	2x2, 4500lm, 80CRI, 3500K, Ribbed Diffuser, UNV 120-277V, 0-10V	DLC Standard	1/52	PA
■ 2FGG45L840-2-D-UNV-DIM	784197242251	912401282078	2x2, 4500lm, 80CRI, 4000K, Ribbed Diffuser, UNV 120-277V, 0-10V	DLC Standard	1/52	PA
<b>FluxGrid 2x2 for Grid NEMA G 15/16" with Round Smooth Lens</b>						
■ 2FGXG20L835-2-RS-UNV-DIM-SWZCS	-	912401608349	2x2, 2000lm, 80CRI, 3500K, Round Smooth Lens, UNV 120-277V, 0-10V, Interact Pro scalable	DLC Premium	1/52	Factory
■ 2FGXG20L840-2-RS-UNV-DIM-SWZCS	-	912401608350	2x2, 2000lm, 80CRI, 4000K, Round Smooth Lens, UNV 120-277V, 0-10V, Interact Pro scalable	DLC Premium	1/52	Factory
■ 2FGXG30L835-2-RS-UNV-DIM-SWZCS	-	912401608352	2x2, 3000lm, 80CRI, 3500K, Round Smooth Lens, UNV 120-277V, 0-10V, Interact Pro scalable	DLC Premium	1/52	Factory
■ 2FGXG30L840-2-RS-UNV-DIM-SWZCS	-	912401608353	2x2, 3000lm, 80CRI, 4000K, Round Smooth Lens, UNV 120-277V, 0-10V, Interact Pro scalable	DLC Premium	1/52	Factory
■ 2FGXG38L835-2-RS-UNV-DIM-SWZCS	-	912401608357	2x2, 3800lm, 80CRI, 3500K, Round Smooth Lens, UNV 120-277V, 0-10V, Interact Pro scalable	DLC Premium	1/52	Factory
■ 2FGXG38L840-2-RS-UNV	-	912401607978	2x2, 3800lm, 80CRI, 4000K, Round Smooth Lens, UNV 120-277V, 0-10V	DLC Premium	-	Factory
■ 2FGXG38L840-2-RS-UNV-DIM-SWZCS	-	912401608356	2x2, 3800lm, 80CRI, 4000K, Round Smooth Lens, UNV 120-277V, 0-10V, Interact Pro scalable	DLC Premium	1/52	Factory
■ 2FGXG38L840-2-RS-UNV-DIM-SWZCS	-	912401608054	2x2, 3800lm, 80CRI, 4000K, Round Smooth Lens, UNV 120-277V, 0-10V, Interact Pro scalable	DLC Premium	1/52	Factory
■ 2FGXG38L850-2-RS-UNV-DIM-SWZCS	-	912401608426	2x2, 3800lm, 80CRI, 5000K, Round Smooth Lens, UNV 120-277V, 0-10V, Interact Pro scalable	DLC Premium	1/52	Factory
■ 2FGXG45L840-2-RS-UNV-DIM-SWZCS	-	912401608312	2x2, 4500lm, 80CRI, 4000K, Round Smooth Lens, UNV 120-277V, 0-10V, Interact Pro scalable	DLC Premium	1/52	Factory
■ 2FGXGH38L840-2-RS-UNV-DIM-SWZCS	-	912401608041	2x2, 3800lm, 80CRI, 4000K, Round Smooth Lens, UNV 120-277V, 0-10V, Interact Pro scalable	DLC Premium	1/52	Factory
<b>FluxGrid 2x4 for Grid NEMA G 15/16" with Ribbed &amp; Smooth Diffuser</b>						
■ 2FGG38L835-4-D-UNV-DIM	784197291549	912401462051	2x4, 3800lm, 80CRI, 3500K, Ribbed Diffuser, UNV 120-277V, 0-10V	DLC Standard	1/26	TN
■ 2FGG38L835-4-D-UNV-DIM-SWZDT	-	912401460376	2x4, 3800lm, 80CRI, 3500K, Ribbed Diffuser, UNV 120-277V, 0-10V, SpaceWise	DLC Standard	1/26	Factory
■ 2FGG38L835-4-D-UNV-DIM-SWZCS	-	912401607332	2x4, 3800lm, 80CRI, 3500K, Ribbed Diffuser, UNV 120-277V, 0-10V, Interact Pro scalable	DLC Standard	1/10	Factory
■ 2FGG38L840-4-D-UNV-DIM-SWZDT	-	912401493088	2x4, 3800lm, 80CRI, 4000K, Ribbed Diffuser, UNV 120-277V, 0-10V, SpaceWise	DLC Standard	1/26	TN
■ 2FGG38L840-4-D-UNV-DIM-SWZCS	-	912401607452	2x4, 3800lm, 80CRI, 4000K, Ribbed Diffuser, UNV 120-277V, 0-10V, Interact Pro scalable	DLC Standard	1/10	Factory
● 2FGG42B830-4-D-UNV-DIM	784197242183	912401282085	2x4, 4200lm, 80CRI, 3000K, Ribbed Diffuser, UNV 120-277V, 0-10V	DLC Standard	1/26	Factory
■ 2FGGH42B830-4-D-UNV-DIM-CHIC	784197374358	912401493052	2x4, 4200lm, 80CRI, 3000K, Ribbed Diffuser, UNV 120-277V, 0-10V, Chicago Plenum (Air Return)	DLC Standard	1/26	PA
● 2FGG42B835-4-D-UNV-DIM	784197203658	912401281469	2x4, 4200lm, 80CRI, 3500K, Ribbed Diffuser, UNV 120-277V, 0-10V	DLC Standard	1/26	CA, TN, PA, GA*
■ 2FGG42B835-4-D-UNV-DIM-CHIC	784197375256	912401493046	2x4, 4200lm, 80CRI, 3500K, Ribbed Diffuser, UNV 120-277V, 0-10V, Chicago Plenum	DLC Standard	1/26	PA
■ 2FGGH42B835-4-D-UNV-DIM-CHIC	784197374365	912401493053	2x4, 4200lm, 80CRI, 3500K, Ribbed Diffuser, UNV 120-277V, 0-10V, Chicago Plenum (Air Return)	DLC Standard	1/26	Factory
● 2FGG42B840-4-D-UNV-DIM	784197242237	912401282080	2x4, 4200lm, 80CRI, 4000K, Ribbed Diffuser, UNV 120-277V, 0-10V	DLC Standard	1/26	CA, TN, PA, GA*
● 2FGG42B840-4-DS-UNV-DIM	784197269173	912401283354	2x4, 4200lm, 80CRI, 4000K, Smooth Diffuser, UNV 120-277V, 0-10V	DLC Standard	1/26	TN
● 2FGG42B850-4-D-UNV-DIM	784197242091	912401282094	2x4, 4200lm, 80CRI, 5000K, Ribbed Diffuser, UNV 120-277V, 0-10V	DLC Standard	-	Factory
● 2FGG43L835-4-D-UNV-DIM	784197242312	912401282072	2x4, 4300lm, 80CRI, 3500K, Ribbed Diffuser, UNV 120-277V, 0-10V	DLC Standard	1/26	TN, PA
■ 2FGG43L835-4-D-UNV-DIM-SWZDT	784197380595	912401493266	2x4, 4300lm, 80CRI, 3500K, Ribbed Diffuser, UNV 120-277V, 0-10V, SpaceWise	DLC Standard	1/26	PA
■ 2FGG43L835-4-D-UNV-DIM-SWZCS	-	912401607335	2x4, 4300lm, 80CRI, 3500K, Ribbed Diffuser, UNV 120-277V, 0-10V, Interact Pro scalable	DLC Standard	1/10	PA
● 2FGG43L840-4-D-UNV-DIM	784197242244	912401282079	2x4, 4300lm, 80CRI, 4000K, Ribbed Diffuser, UNV 120-277V, 0-10V	DLC Standard	1/26	TN, PA
■ 2FGG43L840-4-D-UNV-DIM-SWZDT	784197367015	912401493086	2x4, 4300lm, 80CRI, 4000K, Ribbed Diffuser, UNV 120-277V, 0-10V, SpaceWise	DLC Standard	1/26	PA
■ 2FGG43L840-4-D-UNV-DIM-SWZCS	784197702038	912401607336	2x4, 4300lm, 80CRI, 4000K, Ribbed Diffuser, UNV 120-277V, 0-10V, Interact Pro scalable	DLC Standard	1/10	PA

- Stock Ready (returnable)
- Design Ready (non-returnable)

\* Will Call (pickup only)



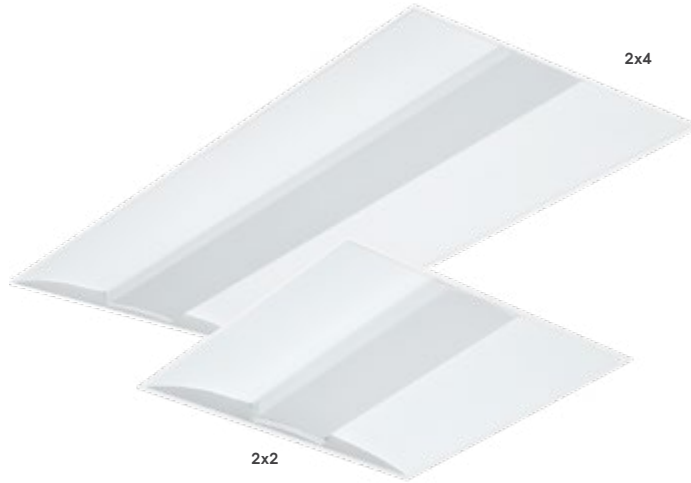

## FluxGrid

(continued)

Catalog Number	UPC Code	Model No.	Product Description	Compliance	C/P Qty	Dist. Center
<b>FluxGrid 2x4 for Grid NEMA G 15/16" with Ribbed &amp; Smooth Diffuser (continued)</b>						
2FGG48L830-4-D-UNV-DIM-CHIC	784197420628	912401502439	2x4, 4800lm, 80CRI, 3000K, Ribbed Diffuser, UNV 120-277V, 0-10V, Chicago Plenum	DLC Standard	1/26	PA
2FGG48L835-4-D-UNV-DIM	784197242305	912401282073	2x4, 4800lm, 80CRI, 3500K, Ribbed Diffuser, UNV 120-277V, 0-10V	DLC Standard	1/26	TN, PA
2FGGH48L835-4-D-UNV-DIM-CHIC	784197420680	912401502441	2x4, 4800lm, 80CRI, 3500K, Ribbed Diffuser, UNV 120-277V, 0-10V, Chicago Plenum (Air Return)	DLC Standard	1/26	PA
2FGG48L840-4-D-UNV-DIM	784197242220	912401282081	2x4, 4800lm, 80CRI, 4000K, Ribbed Diffuser, UNV 120-277V, 0-10V	DLC Standard	1/26	CA, TN, PA
2FGG48L840-4-DS-UNV-DIM	784197284121	912401461559	2x4, 4800lm, 80CRI, 4000K, Smooth Diffuser, UNV 120-277V, 0-10V	DLC Standard	1/26	TN
2FGG54L835-4-D-UNV-DIM	784197242299	912401282074	2x4, 5400lm, 80CRI, 3500K, Ribbed Diffuser, UNV 120-277V, 0-10V	DLC Standard	1/26	TN, PA
2FGG54L840-4-D-UNV-DIM	784197242213	912401282082	2x4, 5400lm, 80CRI, 4000K, Ribbed Diffuser, UNV 120-277V, 0-10V	DLC Standard	1/26	CA, TN, PA
2FGG74L835-4-D-UNV-DIM	784197242152	912401282088	2x4, 7400lm, 80CRI, 3500K, Ribbed Diffuser, UNV 120-277V, 0-10V	DLC Standard	1/26	Factory
2FGG74L840-4-D-UNV-DIM	784197242121	912401282091	2x4, 7400lm, 80CRI, 4000K, Ribbed Diffuser, UNV 120-277V, 0-10V	DLC Standard	1/26	Factory
<b>FluxGrid 2x4 for Grid NEMA G 15/16" with Round Smooth Lens</b>						
2FGXG38L835-4-RS-UNV-DIM-SWZCS	-	912401608351	2x4, 3800lm, 80CRI, 3500K, Round Smooth Lens, UNV 120-277V, 0-10V, Interact Pro scalable	DLC Premium	1/26	Factory
2FGXG38L840-4-RS-UNV-DIM-SWZCS	-	912401608354	2x4, 3800lm, 80CRI, 4000K, Round Smooth Lens, UNV 120-277V, 0-10V, Interact Pro scalable	DLC Premium	1/26	Factory
2FGXG38L840-4-RS-UNV-DIM-SWZCS	-	912401607990	2x4, 3800lm, 80CRI, 4000K, Round Smooth Lens, UNV 120-277V, 0-10V, Interact Pro scalable	DLC Premium	1/26	Factory
2FGXGH38L840-4-RS-UNV-DIM-SWZCS	-	912401608044	2x4, 3800lm, 80CRI, 4000K, Round Smooth Lens, UNV 120-277V, 0-10V, Interact Pro scalable	DLC Premium	1/26	Factory
2FGXG42B840-4-RS-UNV	-	912401607944	2x4, 4200lm, 80CRI, 4000K, Round Smooth Lens, UNV 120-277V, 0-10V	DLC Premium		
2FGXG43L835-4-RS-UNV-DIM-SWZCS	-	912401608355	2x4, 4300lm, 80CRI, 3500K, Round Smooth Lens, UNV 120-277V, 0-10V, Interact Pro scalable	DLC Premium	1/26	Factory
2FGXG43L840-4-RS-UNV-DIM-SWZCS	-	912401608358	2x4, 4300lm, 80CRI, 4000K, Round Smooth Lens, UNV 120-277V, 0-10V, Interact Pro scalable	DLC Premium	1/26	Factory
2FGXG43L850-4-RS-UNV-DIM-SWZCS	-	912401608425	2x4, 4300lm, 80CRI, 5000K, Round Smooth Lens, UNV 120-277V, 0-10V, Interact Pro scalable	DLC Premium	1/26	Factory
2FGXG48L835-4-RS-UNV-DIM-SWZCS	-	912401608196	2x4, 4800lm, 80CRI, 3500K, Round Smooth Lens, UNV 120-277V, 0-10V, Interact Pro scalable	DLC Premium	1/26	Factory
2FGXG48L840-4-RS-UNV-DIM-SWZCS	-	912401608470	2x4, 4800lm, 80CRI, 4000K, Round Smooth Lens, UNV 120-277V, 0-10V, Interact Pro scalable	DLC Premium	1/26	Factory
2FGXG60L840-4-RS-UNV-DIM-SWZCS	-	912401608530	2x4, 6000lm, 80CRI, 4000K, Round Smooth Lens, UNV 120-277V, 0-10V, Interact Pro scalable	DLC Premium	1/26	Factory
2FGXG74L840-4-RS-UNV	-	912401608025	2x4, 7400lm, 80CRI, 7400K, Round Smooth Lens, UNV 120-277V, 0-10V	DLC Premium		
2FGXG85L840-4-RS-UNV	-	-	2x4, 8500lm, 80CRI, 8500K, Round Smooth Lens, UNV 120-277V, 0-10V	DLC Premium		
2FGXG90L840-4-RS-UNV	-	-	2x4, 9000lm, 90CRI, 4000K, Round Smooth Lens, UNV 120-277V, 0-10V	DLC Standard		

- Stock Ready (returnable)
- Design Ready (non-returnable)





## TG LED

Rugged and reliable low profile recessed prismatic lens troffer ideal for school applications

### Why choose TG LED

- Broad range of lumen packages 3200-7400 for varying ceiling heights
- Prismatic lens types suitable for classrooms
- Patterns:
  - 12 .100 nominal diffuse 50%
  - 12F DB 12 .125" nominal diffuse 50%
  - 9F DB 19 .156" nominal diffuse 50%
- Robust door frame with multiple gasket options
- Flexible wiring



### TG LED

Catalog Number	UPC Code	Model No.	Product Description	Compliance	C/P Qty	Dist. Ctr.
<b>TG LED 2x2</b>						
● 2TG30L835-2-FS-02F-UNV-DIM	782343333396	912401080018	2x2, 3000lm, 80CRI, 3500K, Flat Steel Door Frame, Pattern 12 Prismatic Acrylic Lens, UNV 120-277V, 0-10V	DLC Standard	1/52	Factory
● 2TG30L840-2-FS-02F-UNV-DIM	782343332696	912401080014	2x2, 3000lm, 80CRI, 4000K, Flat Steel Door Frame, Pattern 12 Prismatic Acrylic Lens, UNV 120-277V, 0-10V	DLC Standard	1/52	PA
● 2TG38L840-2-FS-02F-UNV-DIM	782343332719	912401260245	2x2, 3800lm, 80CRI, 4000K, Flat Steel Door Frame, Pattern 12 Prismatic Acrylic Lens, UNV 120-277V, 0-10V	DLC Standard	1/52	PA
<b>TG LED 2x4</b>						
● 2TG32L835-4-FS-02F-UNV-DIM	782343331156	912401080007	2x4, 3200lm, 80CRI, 3500K, Flat Steel Door Frame, Pattern 12 Prismatic Acrylic Lens, UNV 120-277V, 0-10V	DLC Standard	1/26	Factory
● 2TG32L840-4-FS-02F-UNV-DIM	190096019694	912401080001	2x4, 3200lm, 80CRI, 4000K, Flat Steel Door Frame, Pattern 12 Prismatic Acrylic Lens, UNV 120-277V, 0-10V	DLC Standard	1/26	TN
● 2TG38L840-4-FS-02F-UNV-DIM	782343330173	912401080002	2x4, 3800lm, 80CRI, 4000K, Flat Steel Door Frame, Pattern 12 Prismatic Acrylic Lens, UNV 120-277V, 0-10V	DLC Standard	1/26	Factory
● 2TG43L835-4-FS-02F-UNV-DIM	782343332030	912401080009	2x4, 4300lm, 80CRI, 3500K, Flat Steel Door Frame, Pattern 12 Prismatic Acrylic Lens, UNV 120-277V, 0-10V	DLC Standard	1/26	PA
● 2TG43L840-4-FS-02F-UNV-DIM	782343330425	912401080003	2x4, 4300lm, 80CRI, 4000K, Flat Steel Door Frame, Pattern 12 Prismatic Acrylic Lens, UNV 120-277V, 0-10V	DLC Standard	1/26	CA
● 2TG48L835-4-FS-02F-UNV-DIM	782343332221	912401080010	2x4, 4800lm, 80CRI, 3500K, Flat Steel Door Frame, Pattern 12 Prismatic Acrylic Lens, UNV 120-277V, 0-10V	DLC Standard	1/26	PA
● 2TG48L840-4-FS-02F-UNV-DIM	782343330432	912401080004	2x4, 4800lm, 80CRI, 4000K, Flat Steel Door Frame, Pattern 12 Prismatic Acrylic Lens, UNV 120-277V, 0-10V	DLC Standard	1/26	PA
● 2TG48L840-4-FS-02F-UNV-DIM-EMLD	781370867881	912401265069	2x4, 4800lm, 80CRI, 4000K, Flat Steel Door Frame, Pattern 12 Prismatic Acrylic Lens, UNV 120-277V, 0-10V. Emergency	DLC Standard	-	Factory
● 2TG54L835-4-FS-02F-UNV-DIM	782343332573	912401080011	2x4, 5400lm, 80CRI, 3500K, Flat Steel Door Frame, Pattern 12 Prismatic Acrylic Lens, UNV 120-277V, 0-10V	DLC Standard	1/26	Factory

- Stock Ready (returnable)
- Design Ready (non-returnable)





## TG8

Quality lighting  
at the lowest price

Low profile recessed prismatic lens troffer  
to match existing fluorescent troffers.



### Why choose TG8?

- Prismatic lens types suitable for classrooms
- Patterns:
  - 12 .100 nominal diffuse 50%
  - 12F DB 12 .125" nominal diffuse 50%
  - 9F DB 19 .156" nominal diffuse 50%
- Robust door frame with multiple gasket options
- Flexible wiring

### TG8

Catalog Number	UPC Code	Model No.	Product Description	Cmp.	C/P Qty	Dist. Ctr.
<b>TG T8 1x4</b>						
● 1TG8232-01-UNV-1/2-EB	781370952631	912401270583	1x4, 2 Lamp, 32W T8, Flat Steel Door Frame, Pattern 12 Prismatic Acrylic Lens, UNV 120-277V, 0-10V, Electronic Ballast	-	1/52	PA
<b>TG T8 2x2</b>						
● 2TG8217R-01-UNV-1/2-EB	781370989132	912400373181	2x2, 2 Lamp, 17W T8, Flat Steel Door Frame, Pattern 12 Prismatic Acrylic Lens, UNV 120-277V, 0-10V, Electronic Ballast	-	1/52	Factory
● 2TG8231U6R-01-UNV-1/2-EB	781370943776	912400372909	2x2, 2 Lamp, 31W U6 T8, Flat Steel Door Frame, Pattern 12 Prismatic Acrylic Lens, UNV 120-277V, 0-10V, Electronic Ballast	-	1/52	PA
● 2TG8232-01-UNV-1/2-EB	734340981889	912400347273	2x2, 2 Lamp, 32W T8, Flat Steel Door Frame, Pattern 12 Prismatic Acrylic Lens, UNV 120-277V, 0-10V, Electronic Ballast	-	1/26	TN
● 2TG8332-01-UNV-1/21-EB	734340976526	912400347245	2x2, 3 Lamp, 32W T8, Flat Steel Door Frame, Pattern 12 Prismatic Acrylic Lens, UNV 120-277V, 0-10V, Electronic Ballast	-	1/26	Factory
● 2TG8332-01-UNV-1/3-EB	734340976533	912400347246	2x2, 3 Lamp, 32W T8, Flat Steel Door Frame, Pattern 12 Prismatic Acrylic Lens, UNV 120-277V, 0-10V, Electronic Ballast	-	1/26	TN, PA
● 2TG8432-01-UNV-1/4-EB	734340976595	912400347248	2x2, 4 Lamp, 32W T8, Flat Steel Door Frame, Pattern 12 Prismatic Acrylic Lens, UNV 120-277V, 0-10V, Electronic Ballast	-	1/26	PA
● 2TG8432-01-UNV-1/4-EB-LPT741	734340981919	912400347276	2x2, 4 Lamp, 32W T8, Flat Steel Door Frame, Pattern 12 Prismatic Acrylic Lens, UNV 120-277V, 0-10V, Electronic Ballast	-	1/26	TN
<b>TG Accessories</b>						
● TG8FS01D	782343040713	912400347583	2x4 Pattern 12 Prismatic Acrylic Lens Replacement Door Frame Assembly	-	1/10	Factory

- Stock Ready (returnable)
- Design Ready (non-returnable)

## SofTrace Gen2

A family of classic fully luminous aperture troffers

Pairs a contoured upper reflector with efficiency, visual comfort and wired and wireless controls.

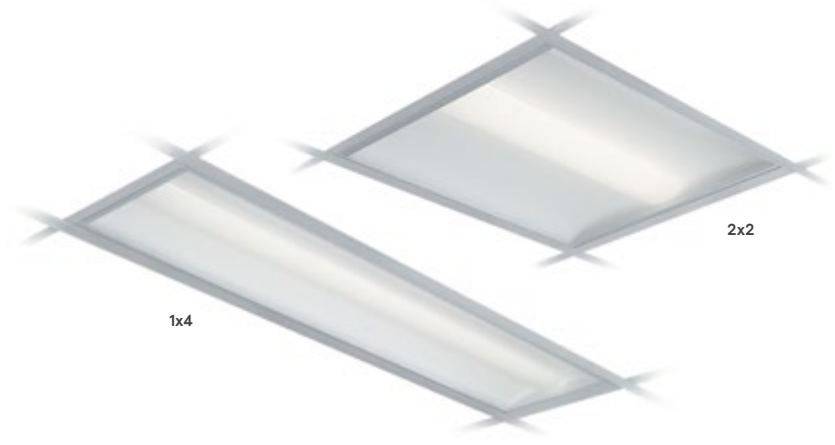

### Why choose SofTrace Gen2?

- DLC Standard and Premium options
- Wet location listed
- Antimicrobial finish
- Full lambertian light distribution assures uniform illumination from floor to ceiling
- Integral controls
- 5-year warranty<sup>1</sup>



### SofTrace

Catalog Number	UPC Code	Model No.	Product Description	Compliance	C/P Qty	Dist. Center
<b>SofTrace Gen2 1x4</b>						
1STXG38B835-4-D-UNV-DIM	784197669881	912401496502	1x4, 3800lm, 80CRI, 3500K, Diffuse Lens, UNV 120-277V, 0-10V	DLC Standard	-	Factory
1STXG38B835-4-D-UNV-DIM-BSL10LST	784197670078	912401496522	1x4, 3800lm, 80CRI, 3500K, Diffuse Lens, UNV 120-277V, 0-10V, 10W Emergency	DLC Standard	-	Factory
1STXG38B840-4-D-UNV-DIM	784197669898	912401496503	1x4, 3800lm, 80CRI, 4000K, Diffuse Lens, UNV 120-277V, 0-10Vr	DLC Standard	-	Factory
1STXG38B840-4-D-UNV-DIM-BSL10LST	784197670085	912401496523	1x4, 3800lm, 80CRI, 4000K, Diffuse Lens, UNV 120-277V, 0-10V, 10W Emergency	DLC Standard	-	Factory
<b>SofTrace Gen2 2x2</b>						
2STXG38B835-2-D-UNV-DIM	784197669904	912401496504	2x2, 3800lm, 80CRI, 3500K, Diffuse Lens, UNV 120-277V, 0-10V	DLC Standard	-	Factory
2STXG38B840-2-D-UNV-DIM	784197669911	912401496505	2x2, 3800lm, 80CRI, 4000K, Diffuse Lens, UNV 120-277V, 0-10V	DLC Standard	-	Factory
<b>SofTrace Gen2 2x4</b>						
2STXG42B835-4-D-UNV-DIM	784197669928	912401496506	2x4, 4200lm, 80CRI, 3500K, Diffuse Lens, UNV 120-277V, 0-10V	DLC Standard	-	Factory
2STXG42B835-4-D-UNV-DIM-BSL10LST	784197670115	912401496526	2x4, 4200lm, 80CRI, 3500K, Diffuse Lens, UNV 120-277V, 0-10V, 10W Emergency	DLC Standard	-	Factory
2STXG42B840-4-D-UNV-DIM	784197669935	912401496507	2x4, 4200lm, 80CRI, 4000K, Diffuse Lens, UNV 120-277V, 0-10V	DLC Standard	-	Factory
2STXG42B840-4-D-UNV-DIM-BSL10LST	784197670122	912401496527	2x4, 4200lm, 80CRI, 4000K, Diffuse Lens, UNV 120-277V, 0-10V, 10W Emergency	DLC Standard	-	Factory

1. Visit [signify.com/warranties](http://signify.com/warranties) for full warranty information.





2x2

2x4

## Coffaire

### Two lights in one

Coffaire is a contoured reflector with a perforated mesh center shield that provides indirect lighting with a soft direct component for visual interest.



### Why choose Coffaire?

- Dust and Insect shielding options for challenging environments
- Lampshield hinges on either side for convenient cleaning and maintenance
- Designed for standard 9/16 and exposed slot T Grid ceilings
- G type and drywall kits available
- Built in earthquake clips

### Coffaire

Catalog Number	UPC Code	Model No.	Product Description	Comp.	C/P Qty	Dist. Center
<b>Coffaire 2x2</b>						
■ CFS2GPF217UNV-1/2-EB	782343969809	912400384727	2x2, 2 Lamp, 17W T8, Perf Diffuser w/ White Overlay, UNV 120-277V, Electronic Ballast	-	1/32	TN
<b>Coffaire 2x4</b>						
■ CFS2GPF228UNV-1/2-EB	782343917831	912401025240	2x4, 2 Lamp, 28W T5, Perf Diffuser w/ White Overlay, UNV 120-277V, Electronic Ballast	-	1/16	Factory
■ CFH2GPF228UNV-1/2-EB	782343932681	912401025247	2x4, 2 Lamp, 28W T5, Perf Diffuser w/ White Overlay, Air Return, UNV 120-277V, Electronic Ballast	-	1/16	PA
■ CFS2GPF232UNV-1/2-EB	782343969823	912400384729	2x4, 2 Lamp, 32W T8, Perf Diffuser w/ White Overlay, UNV 120-277V, Electronic Ballast	-	1/16	Factory
■ CFH2GPF232UNV-1/2-EB	782343917688	912401025237	2x4, 2 Lamp, 32W T8, Perf Diffuser w/ White Overlay, Air Return, UNV 120-277V, Electronic Ballast	-	1/16	TN
■ CFS2GPF332UNV-1/3-EB	782343916919	912400393909	2x4, 3 Lamp, 32W T8, Perf Diffuser w/ White Overlay, UNV 120-277V, Electronic Ballast	-	1/16	TN
■ CFH2GPF332UNV-1/3-EB	782343917657	912401025235	2x4, 3 Lamp, 32W T8, Perf Diffuser w/ White Overlay, Air Return, UNV 120-277V, Electronic Ballast	-	1/16	TN

- Stock Ready (returnable)
- Design Ready (non-returnable)



## 44R Line Edge-lit LED



Features a contemporary compact design. The universal 44R exit can be surface mounted (ceiling, wall, end) or recessed mounted (ceiling, wall) all with one specified catalog number.

### Why choose 44R Line LED?

- Universal mounting
- Self-diagnostic standard (universal mount)
- Self-test standard (universal mount)
- UL damp location listed
- Field selectable self-adhesive chevrons
- DoE compliant



### 44R Line Edge-lit LED

Catalog No.	UPC Code	Model No.	Product Description	Case Qty	Pallet Qty	Dist. Center
44RL1R	734340234114	912400343438	Surface mount edge-lit LED, AC only, single face, satin aluminum housing with black end caps, red font	6	270	CA
44RL2R	734340234121	912400343439	Surface mount edge-lit LED, AC only, double face, satin aluminum housing with black end caps, red font	6	162	CA
44RLU1G	734340234510	912400343457	Exit sign, edge-lit LED, AC only, double face, green font	3	54	CA
44RLU1GM	782343026403	912400347486	Universal mount edge-lit LED, AC only, single face, satin aluminum housing with black end caps, green font on mirror	3	3	CA
44RLU1R	734340234497	912400343455	Universal mount edge-lit LED, AC only, single face, satin aluminum housing with black end caps, red font	3	90	CA
44RLU1WR	734340234534	912400343459	Universal mount edge-lit LED, AC only, single face, white finish housing with white end caps, red font	3	54	CA
44RLU2G	734340234527	912400343458	Exit sign, edge-lit LED, AC only, single face, green font	3	72	CA
44RLU2R	734340234503	912400343456	Universal mount edge-lit LED, AC only, double face, satin aluminum housing with black end caps, red font	3	54	CA
44RLU2WR	734340234558	912400343460	Universal mount edge-lit LED, AC only, double face, white finish housing with white end caps, red font	3	54	CA
ER44RL1R	734340453713	912400344611	Surface mount edge-lit LED, single face, satin aluminum housing with black end caps, red font	6	216	CA
ER44RLDU1G	734340234404	912400343449	Universal mount edge-lit LED with self test/self diagnostics, single face, satin aluminum housing with black end caps, green font	6	24	CA, TN
ER44RLDU1R	734340234367	912400343447	Universal mount edge-lit LED with self test/self diagnostics, single face, satin aluminum housing with black end caps, red font	3	54	CA, TN, PA
ER44RLDU1RM	782343026397	912400347485	Universal Mount, Emergency Operation Nicad Battery, Single Face, Red Letters, Mirror Background, Satin Aluminum Housing	6	90	TN
ER44RLDU1WG	734340234466	912400343453	Universal mount edge-lit LED with self test/self diagnostics, single face, white finish housing with white end caps, green font	6	90	CA
ER44RLDU1WR	734340234442	912400343451	Universal mount edge-lit LED with self test/self diagnostics, single face, white finish housing with white end caps, red font	6	72	CA
ER44RLDU2G	734340234411	912400343450	Universal mount edge-lit LED with self test/self diagnostics, double face, satin aluminum housing with black end caps, green font	6	36	CA
ER44RLDU2R	734340234374	912400343448	Universal mount edge-lit LED with self test/self diagnostics, double face, satin aluminum housing with black end caps, red font	3	54	CA, TN, PA
ER44RLDU2WG	734340234473	912400343454	Universal mount edge-lit LED with self test/self diagnostics, double face, white finish housing with white end caps, green font	6	24	CA
ER44RLDU2WR	734340234459	912400343452	Universal mount edge-lit LED with self test/self diagnostics, double face, white finish housing with white end caps, red font	6	108	CA
<b>44R Line Edge-Lit NYC Universal Edge Lit LED Exit</b>						
ER44RLDU1RNYC	782343568255	912400351437	Universal Mount, Emergency Operation Nicad Battery, Single Face, 8" Red Letters, Mirror Background, Satin Aluminum Housing	2	48	PA
ER44RLDU2RNYC	782343568262	912400351438	Universal Mount, Emergency Operation Nicad Battery, Double Face, 8" Red Letters, Mirror Background, Satin Aluminum Housing	2	48	PA
44RLU1RNYC	784197684341	912400351435	Universal mount edge-lit LED, AC only, single face, satin aluminum housing with black end caps, red font	2	48	#N/A
44RLU2RNYC	782343568248	912400351436	Universal mount edge-lit LED, AC only, double face, satin aluminum housing with black end caps, red font	2	48	#N/A

- Stock Ready (returnable)
- Design Ready (non-returnable)





## 45V Line Edge-lit LED

High quality specification grade edge-lit exit sign that is aesthetically appealing and designed for architectural excellence. It includes self-diagnostic/self-test circuitry, standard on all models.

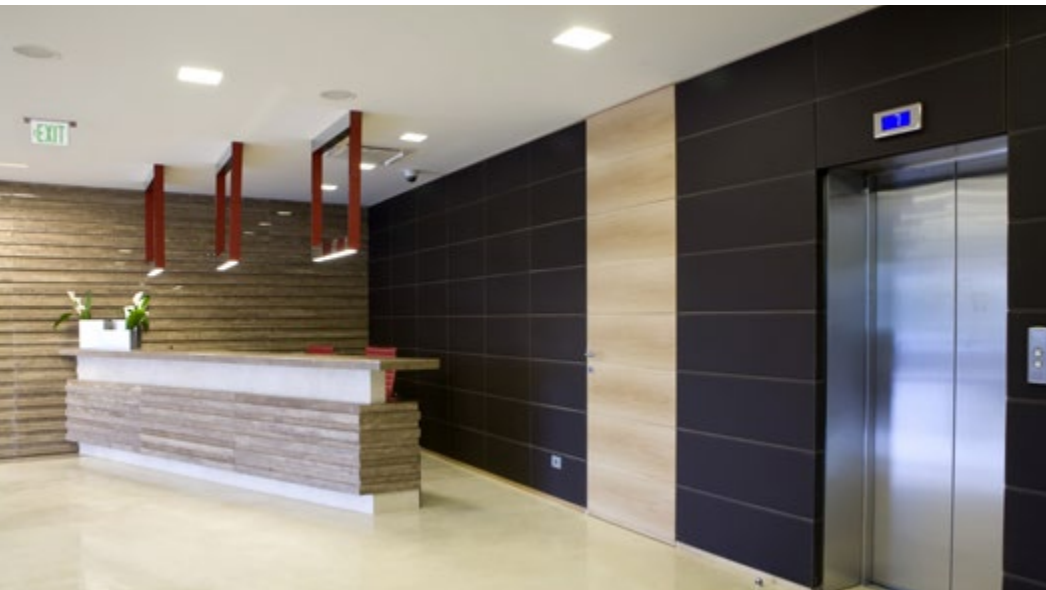

### Why choose 45V Line LED?

- Self-diagnostic standard
- Self-test standard
- Special wording available
- Injection molded wedge shaped panel
- California Energy Commission compliant
- Precision molded, etched letters and chevrons
- Exit panel is ultrasonically welded together eliminating the need for visible hardware
- DoE compliant

### 45V Line Edge-lit LED

Catalog Number	UPC Code	Model Number	Product Description	Case Qty	Pallet Qty	Distribution Center
■ BB45VL	781370614928	912401025366	Back Box Rough In Section, AC Only	1	176	CA, TN, PA
● BBER45VXL	781370518127	912400370603	Back Box Rough In Section, Emergency Operation Nicad Battery	1	176	CA, TN, PA
■ T45VL1RMAR	-	912400371726	Edge-lit, trim and pnl, AC only, single face, red on mirror, right chevron	1	176	CA, TN, PA
■ T45VL1RMAD	-	912400372174	Edge-lit, trim and pnl, AC only, single face, red on mirror, left and right chevron	1	176	CA, TN, PA
■ T45VL2RMAD	-	912401025371	Edge-lit, trim and pnl, AC only, double face, red on mirror, left and right chevron			
■ T45VL2RMLR	-	912401025370	Edge-lit, trim and pnl, AC only, double face, red on mirror, left or right chevron for double face			
■ TER45VXL1RMAR	-	912400390323	Edge-lit, trim and pnl, NiCad, Single face, red on mirror, right chevron			
■ TER45VXL1RMAD	-	912400371925	Edge-lit, trim and pnl, NiCad, Single face, red on mirror, left and right chevron			
■ TER45VXL2RMAD	-	912400371107	Edge-lit, trim and pnl, NiCad, Double face, red on mirror, left and right chevron			
■ TER45VXL2RMLR	-	912401025365	Edge-lit, trim and pnl, NiCad, Double face, red on mirror, left or right chevron for double face			
■ T45VL2GMAD	-	912400371024	Edge-lit, trim and pnl, AC only, double face, green on mirror, left and right chevron			
■ T45VL2GMLR	-	912400371039	Edge-lit, trim and pnl, AC only, double face, green on mirror, left or right chevron for double face			
■ TER45VXL2GMAD	-	912400370982	Edge-lit, trim and pnl, NiCad, Double face, green on mirror, left and right chevron			
■ TER45VXL2GMLR	-	912401025372	Edge-lit, trim and pnl, NiCad, Double face, green on mirror, left or right chevron for double face			

- Stock Ready (returnable)
- Design Ready (non-returnable)



## 55 Line Die-Cast LED



Low profile, die cast aluminum commercial exit sign offering even illumination of letters and high-end aesthetics.

### Why choose 55 Line LED?

- Universal mounting
- Self-diagnostic standard (ER55LD models)
- Self-test standard (ER55LD models)
- UL damp location listed
- Universal face plates
- Field removable chevrons
- DoE compliant



### 55 Line Die-Cast LED

Catalog No.	UPC Code	Model No.	Product Description	Case Qty	Pallet Qty	Dist. Center
55L3G	782343842546	912401025209	Universal Mount, AC Only, Single/Double Face, Green Letters, Black Housing w/ Satin Aluminum Housing	6	180	CA
55L3R	781370104085	912401025273	Universal Mount, AC Only, Single/Double Face, Red Letters, Black Housing w/ Satin Aluminum Housing	6	120	CA
55L3WG	781370104092	912401025274	Universal Mount, AC Only, Single/Double Face, Green Letters, White Housing	6	180	CA
55L3WR	782343390580	912400349641	Universal Mount, AC Only, Single/Double Face, Red Letters, White Housing	6	240	CA
ER55L3G	781370104054	912401025271	Universal Mount, Emergency Operation Nicad Battery, Single/Double Face, Green Letters, Black Housing w/ Satin Aluminum Face	6	240	CA
ER55L3R	781370104047	912401025270	Universal Mount, Emergency Operation Nicad Battery, Single/Double Face, Green Letters, Black Housing w/ Satin Aluminum Face	6	180	CA
ER55L3WG	781370104078	912401025272	Universal Mount, Emergency Operation Nicad Battery, Single/Double Face, Green Letters, White Housing	6	270	CA
ER55L3WR	781370621698	912400371075	Universal Mount, Emergency Operation Nicad Battery, Single/Double Face, Red Letters, White Housing	6	240	CA
ER55LD3G	781370410100	912401025329	Universal Mount, Emergency Operation Nicad Battery, Single/Double Face, Green Letters, Black Housing w/ Satin Aluminum Face	6	120	CA
ER55LD3R	781370410094	912401025328	Universal Mount, Emergency Operation Nicad Battery, Single/Double Face, Red Letters, Black Housing w/ Satin Aluminum Face	6	180	CA
ER55LD3WR	781370410117	912400390155	Universal Mount, Emergency Operation Nicad Battery, Single/Double Face, Red Letters, White Housing	6	180	CA

- Stock Ready (returnable)
- Design Ready (non-returnable)



## 60 Line Die-Cast LED

Designed to meet the demands of today's most extreme environments. Built for extreme temperatures and vandal resistant applications.



### Why choose 60 Line LED?

- Self-diagnostic / Self-test standard
- Special wording available
- NEMA Premium certified
- Meets medical military facilities specification
- UL Wet location listed
- Field selectable chevrons (removable and replaceable)
- Universal mounting
- Tamper resistant / vandal resistant

### 60 Line Die-Cast LED

Catalog No.	UPC Code	Model No.	Product Description	Case Qty	Pallet Qty	Dist. Center
■ 60MLA3RW	781370995416	912401025428	Universal Mount, AC Only, Single Face w/Extra Faceplate, Red Letters, White Housing, White Face Plate	1	100	TN
■ ER60MLD3RB	781370921286	912400372810	Universal Mount, Emergency Operation Nicad Battery, Single Face w/Extra Faceplate, Red Letters, Black Housing, Black Face Plate	1	90	TN
■ ER60MLD3RW	781370921309	912400372812	Universal Mount, Emergency Operation Nicad Battery, Single Face w/Extra Faceplate, Red Letters, White Housing, White Face Plate	1	81	TN

- Stock Ready (returnable)
- Design Ready (non-returnable)



## Compac Units LED

A general purpose exit and emergency family that is designed to complement the Compac LED family. The unobtrusive look offers great aesthetics yet delivers optimum performance.



### Why choose Compac Units LED?

- Low profile unobtrusive designs
- Nickel metal hydride battery (CLU Nickel cadmium)
- Designed for wall or ceiling mounting
- Self-diagnostic, self-test electronics



### Compac Units LED

Catalog Number	UPC Code	Model Number	Product Description	Case Qty	Pallet Qty	Distribution Center
CLCNGW	784197421274	912401502522	Compac LED Exit Combo, Nickel Metal Hydride Battery, Green Letters, White	6	6	CA
CLCNGW2R	784197421298	912401502524	Compac LED Exit Combo, Nickel Metal Hydride Battery, Green Letters, White, Remote Capability	6	6	CA
CLCNRW	784197421267	912401502521	Compac LED Exit Combo, Nickel Metal Hydride Battery, Red Letters, White	6	6	CA, TN, PA
CLCNRW2R	784197421281	912401502523	Compac LED Combo, Nickel Metal Hydride Battery, Red Letters, White, Remote Capability	6	6	CA
CLR1W	784197421151	912401502509	Compac LED Remote Unit, Single LED Lamp Head, White	24	24	CA
CLR2W	784197421304	912401502525	Compac LED Remote Unit, Dual LED Lamp Heads, White	24	24	CA
CLR2WG	784197650551	912401493893	Compac LED Remote, 2 head	1	1	TN
CLU2NW	784197421144	912401502516	Compac LED 2 Lamp Head Emergency Unit, Nickel Metal Hydride Battery, White	6	6	CA, TN, PA
CLU2NW2R	784197421175	912401502510	Compac LED 2 Lamp Head Emergency Unit, Nickel Metal Hydride Battery, White, Remote Capability	6	6	CA
CLU3NW	784197421182	912401502511	Compac LED 3 Lamp Head Emergency Unit, Nickel Metal Hydride Battery, White	6	6	CA
CLU3NW1R	784197421199	912401502512	Compac LED 3 Lamp Head Emergency Unit, Nickel Metal Hydride Battery, White, Remote Capability	1	1	CA
CLUNW	784197421168	912401502515	Compac LED 2 Lamp Head Emergency Unit, Nickel Cadmium Battery, Compact White Cabinet	24	24	CA, TN, PA
CLUR3NW	784197421205	912401502513	Compac LED Recessed 3 Lamp Head Emergency Unit, Nickel Metal Hydride Battery, White	6	6	CA
CLXAGW	784197421229	912401502517	Compac LED Exit, AC Only, Green Letters, White	6	6	CA
CLXARW	784197421212	912401502514	Compac LED Exit, AC Only, Red Letters, White	6	6	CA
CLXNGW	784197421243	912401502519	Compac LED Exit, Nickel Metal Hydride Battery, Green Letters, White	6	6	CA
CLXNRW	784197421236	912401502518	Compac LED Exit, Nickel Metal Hydride Battery, Red Letters, White	6	6	CA, TN, PA
CLXNRW4R	784197421250	912401502520	Compac LED Exit, Nickel Metal Hydride Battery, Red Letters, White, Remote Capability	6	6	CA

- Stock Ready (returnable)
- Design Ready (non-returnable)



## DEB Series

A host of solutions ensuring power is always available and when you need it most.



### Why choose DEB Series?

- Emergency ballasts for fluorescent applications
- Provides 90 minutes of emergency illumination
- Suitable for indoor and damp locations and for sealed and gasketed fixtures including installation inside of fixtures rated for wet locations

### DEB Series

Catalog Number	UPC Code	Model Number	Product Description	Case Qty	Pallet Qty	Distribution Center
■ DEB-1W	734340643596	912400345722	Emergency Ballast, 350-450 Lumens, One Lamp Operation, Fluorescent	20	1000	TN
■ DEB-5W	734340624021	912400345623	Emergency Ballast, 1100-1400 Lumens, One or Two Lamp Operation, Fluorescent	10	780	TN
■ DEB-7W	782343823422	912400359847	Emergency Ballast, 600-700lm, One or Two Lamp Operation, Fluorescent	1	600	PA

- Stock Ready (returnable)
- Design Ready (non-returnable)



## Edge-Glo Edge-Lit LED



Attractive chamfered acrylic panel with floating letters. Bottom edge of panels reflectorized to facilitate even illumination.

### Why choose Edge-Glo LED?

- Red on white signs with Chicago code arrows
- Injection molded clear acrylic panels with chamfered edges
- Bottom edge is reflectorized to facilitate uniform illumination



### Edge-Glo Edge-Lit LED

Catalog Number	UPC Code	Model Number	Product Description	Case Qty	Pallet Qty	Distribution Center
PG1RWSA2W	781370526450	912400391642	Edge-Glo STAIRS Panel, single face, Red letters on white background, no arrows, white faceplate	1	70	Factory
PG1RWSA3W	782343255216	912400392743	Edge-Glo EXIT Panel, single face, Red letters on white background, no arrows, white faceplate	1	70	PA, IL
PG1RWSA6W	782343256336	912400392748	Edge-Glo EXIT Panel, single face, Red letters on white background, right arrow, white faceplate	1	70	PA
PG1RWSA9W	782343256190	912400392747	Edge-Glo EXIT Panel, single face, Red letters on white background, left arrow, white faceplate	1	100	PA
PG2RWSA20W	781370039295	912400391116	Edge-Glo STAIRS Panel, double face, Red letters on white background, left or right arrows, white faceplate	1	70	Factory
PG2RWSA21W	782343257463	912400392755	Edge-Glo EXIT Panel, double face, Red letters on white background, left or right arrows, white faceplate	1	70	TN, PA, IL
RGLOLEDW	781370491291	912401262211	Edge-Glo Recessed Housing, AC Only, White LEDs.	1	91	PA, IL
RGLOLEDXW	781370491253	912401262210	Edge-Glo Recessed Housing, nicad battery, White LEDs.	1	91	PA
SGLOLEDWW	781370491246	912401262209	Edge-Glo Surface Housing, AC Only, White LEDs, white housing	1	120	PA, IL
SGLOLEDXWW	781370491215	912401262207	Edge-Glo Surface Housing, nicad battery, White LEDs, white housing	1	91	PA

- Stock Ready (returnable)
- Design Ready (non-returnable)





## MSL Mini Step Light LED

Recessed 120VAC AC only mini step light for low-level illumination of stairwells, hallways, corridors, ramps and exits.



### Why choose MSL Mini Step Light LED?

- One piece design installs in standard single gang switch box
- White LEDs, color temperature 2700K
- Vertical or horizontal louvered face plates in brushed aluminum, black or brown
- UL damp location listed

### MSL Mini Step Light LED

Catalog Number	UPC Code	Model Number	Product Description	Case Qty	Pallet Qty	Distribution Center
MSLL	734340107807	912401025012	White LED, White Universal Louver Faceplates (Vertical and Horizontal), 120VAC	24	2400	CA

- Stock Ready (returnable)
- Design Ready (non-returnable)



# Patron LED Wall Light

This stylish design is an excellent choice for architectural emergency lighting in either interior or exterior paths of egress.



## Why choose Patron LED Wall Light?

- Self-diagnostic standard
- Self-test standard
- UL wet location listed
- Marine grade die cast housing
- Provides linear and forward throw light distribution with all in one optic design
- AC only/Emergency Patron Unit contains integral nickel cadmium battery
- UV stable polycarbonate lens



### Patron LED Wall Light

Catalog Number	UPC Code	Model Number	Product Description	Case Qty	Pallet Qty	Dist. Center
■ PDNBZ	781370379858	912401025308	Die Cast Aluminum Bronze Housing, Nicad Battery, 6V 6W, Halogen Lamp	2	96	CA
● PLACEMBZ	782343573235	912400351489	Wall Light, Die Cast Aluminum Bronze Housing, AC 120/277V w/ Integral Nicad Battery Backup, 6V 8-3W LEDs	2	54	CA
■ PLEMBZ	782343522431	912401025123	Wall Light, Die Cast Aluminum Bronze Housing, Nicad Battery, 6V 8-3W LEDs	2	72	CA
■ PLEMW	782343573228	912400351488	Wall Light, Die Cast Aluminum White Housing, Nicad Battery, 6V 8-3W LEDs	2	54	CA

- Stock Ready (returnable)
- Design Ready (non-returnable)



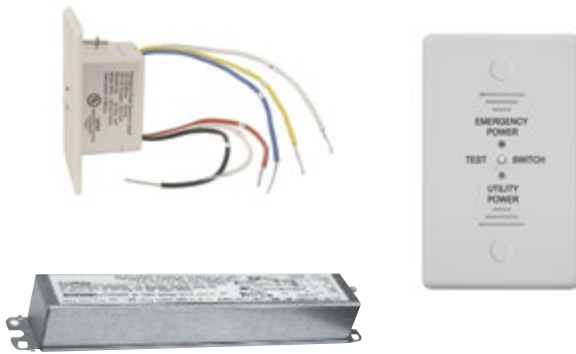

# Transfer Circuit Device

A host of solutions ensuring power is always available and when you need it most.



## Why choose Transfer Circuit Device?

- Auxiliary power transfer device
- MTD - internal luminaire mounted
- MTD20-277 suited for wall or ceiling mounting

### Transfer Circuit Device

Catalog Number	UPC Code	Model Number	Product Description	Case Qty	Pallet Qty	Distribution Center
■ MTD	781370584191	912400370843	Auxiliary Power Transfer Device (Internal Luminaire Mounted)	10	320	PA
■ MTD20-277	781370988821	912401025422	Auxiliary Power Transfer Device 277V (Wall or Ceiling Mounted)	42	840	Factory

- Stock Ready (returnable)
- Design Ready (non-returnable)



## Value+ Family

Basic exit that offers a low profile design, giving it stylish appeal suitable for any general purpose application.



### Why choose Value+ Family?

- Thermoplastic (off white) ABS housing
- Low profile, snap together quick mount design
- Universal wall/ceiling/end mounting
- UL damp location listed
- Pop out chevron directional indicators are easily removed when required
- Extra stencil faceplate for double face sign applications
- 6V maintenance free nickel cadmium battery



### Value+ Family

Catalog Number	UPC Code	Model Number	Product Description	Case Qty	Pallet Qty	Distribution Center
• VEGW	782343263020	912400348806	Universal Mount, AC Only, Green Letters, White Thermoplastic Housing	12	144	CA
• VEGWEM	782343263044	912400348808	Exit Sign, Green With Nicad battery	12	288	CA, TN, PA
• VERW	782343263006	912400348805	Universal Mount, AC Only, Red Letters, White Thermoplastic Housing	12	384	CA, TN, PA
• VERWEM	782343263037	912400348807	Exit Sign, Red With Nicad battery	12	288	CA, TN, PA, IL, GA*

- Stock Ready (returnable)
- Design Ready (non-returnable)



## Value+ Family

General purpose emergency product that features a low profile design giving it a stylish appeal suitable for any general purpose application.



### Why choose Value+ Family?

- Wall, ceiling and surface mounting provisions
- Long life LED lamps
- 3.6V maintenance free nickel cadmium battery
- UL damp location listed

### Value+ Family

Catalog Number	UPC Code	Model Number	Product Description	Case Qty	Pallet Qty	Distribution Center
● VLL1R	784197043926	912401289509	Indoor Remote (1) Head	24	960	CA, GA*
● VLL1RGO	784197043940	912401289511	Outdoor Remote (1) Head	12	360	CA
● VLL2R	784197043933	912401289510	Indoor Remote (2) Head	24	960	CA, GA*
● VLL2RGO	784197043957	912401289512	Outdoor Remote (2) Head	6	150	CA, TN, PA
■ VLLCG	784197043896	912401289506	Value + Economy Grade Emergency Combo unit 3.6V and (2) 1 watt LED lamps. No remote capability. Green letters	12	324	CA
● VLLCG2R	784197043902	912401289507	Value + Economy Grade Emergency Combo unit 3.6V and (2) 1 watt LED lamps. With remote capability. Green letters	12	324	CA, IL, GA*
● VLLCR	784197043865	912401289503	Value + Economy Grade Emergency Combo unit 3.6V and (2) 1 watt LED lamps. No remote capability. Red letters	12	324	CA, TN, PA, IL
● VLLCR2R	784197043872	912401289504	Value + Economy Grade Emergency Combo unit 3.6V and (2) 1 watt LED lamps. With remote capability. Red letters	12	324	CA, TN, PA, IL
● VLLU	784197038342	912401289498	Value + Economy Grade 3.6V LED Emergency white and (2) 1 watt LED lamps	12	96	CA, TN, PA, IL, GA*
● VLLU2	784197043858	912401289502	Value + Economy Grade 3.6V LED Emergency white and (2) 2 watt LED lamps	12	96	CA, TN, PA
● VLLUR	784197043834	912401289499	Value + Economy Grade 3.6V LED Emergency white and (2) 1 watt LED lamps and remote head capability	12	96	CA, TN, PA
● VLT1R	784197302344	912401461341	Value+ LED indoor remote, 3.6V, white housing, 1-1W LED lamp	12	12	CA
● VLT2R	784197302276	912401461410	Value+ LED indoor remote, 3.6V, white housing, 2-1W LED lamp	6	6	CA
■ VLTG3R	784197302337	912401461340	Value+ exit unit combo, 3.6V, green font, white housing, 2-1W LED lamps, remote capable (2-1W or 1-2W lamp heads)	4	4	CA
● VLTOR3R	784197302368	912401461342	Value+ exit unit combo, 3.6V, red font, white housing, 2-1W LED lamps, remote capable (2-1W or 1-2W lamp heads)	4	4	CA, TN, PA
● VLTU	784197302290	912401461338	Value+ LED emergency unit, 3.6V, white housing, 2-1W LED lamps	6	6	CA, TN, PA
● VLTUR	784197302306	912401461339	Value+ LED emergency unit, 3.6V, white housing, 2-1W LED lamps, remote capable (201W or 1-2W heads)	6	6	CA, GA*

- Stock Ready (returnable)
- Design Ready (non-returnable)



## Accessory Wire Guards

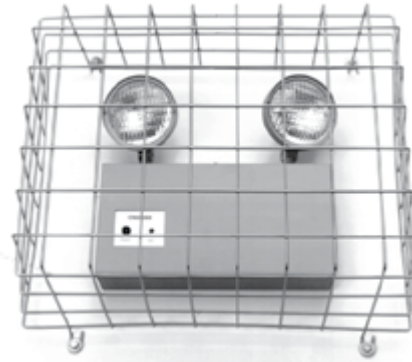

### Why choose Accessory Wire Guards?

- WG4 - Accessory wire guard for use with: wall mount thermoplastic, die cast and steel standard exits, Patron and SL series
- WG5 - Accessory wire guard for 6M2M series, CMF/CNM series (25-100W), HZ series, Steel Lite series, Symmetry series (units and combination), TMF/TNM series (25-150W), ZMF series (100W)



### Accessory Wire Guards

Catalog Number	UPC Code	Model Number	Product Description	Case Qty	Pallet Qty	Distribution Center
WG4	734340115352	912400342802	Wire guard accessory	1	119	Factory
WG5	734340085648	912400342659	Wire guard accessory	1	320	Factory



## Why choose Philips Dynalite?

- Preset lighting control
  - Philips Dynalite allows you to create ambiance and recall different lighting scenes to suit your mood and the occasion
- Distributed control and monitoring
  - you can configure and control all the lights from any point on the network
- Ease of installation and configuration
  - the system is easier to install and takes less time to configure than conventional systems

## Philips Dynalite

Catalog Number	UPC Code	Model Number	Product Description	Case Qty	Pallet Qty	Distribution Center
<b>Indoor Connected Network Controls</b>						
■ ENVISIONGATEWAY (PDEG)	8718696001721	913703013809	10/100 Baset Gateway MPP ENET	1	1	TN
■ DDRC1220FR-GL-V3	8718696887950	913703243009	DDRC1220FR-GL-12Ch 20A Feed Thru Relay	1	1	TN
■ DDBC1200	8718696888735	913703333909	12 X Channel driver control controller (1-10, DSI or DALI)	1	1	TN
■ DDBC120-DALI	8718696887042	913703685109	MultiMaster DALI Driver Controller	1	1	TN
■ DUS360CR	8718696886403	913703500709	Multi-Sensor (PIR+Day) IR Rcvr-Recessed	1	1	TN
■ DUS804CS-UP-NA	8710163527666	913703570709	Sensor Ceiling Mount Ultrasonic / PIR	1	1	TN
■ DACM-DyNet	8718696890387	913703072809	Dynalite Antumbra Communication Module	5	10,000	TN
■ SWI24-24-N-SC	662057980669	912400534747	AC/DC Wall Power Supply, 24W 24V	112	672	TN

- Stock Ready (returnable)
- Design Ready (non-returnable)



## Why choose Occuswitch?

- Slide dimming
  - model uses an intuitive, captive slider knob
- Versatile gang configuration
  - model fits in a single-gang box and can be used in multi-gang configurations
- Recommended for executive offices, boardrooms and conference rooms, lobbies, dining rooms and restaurants, retail stores and residential
- UL/CSA listed



## Occuswitch

Catalog Number	UPC Code	Model Number	Product Description	Case Qty	Pallet Qty	Distribution Center
<b>Indoor Standalone Controls</b>						
LCA2285/00	-	912400473978	OccuSwitch Classic Series PowerPack, 120-230-277V	10	360	TN
LRM2255/00	662057646190	912400474167	Multi-tech-Ceiling Mnt Sensor Low volt 2000 sq.ft.	10	480	TN
LRS2210/00	662057646084	912400474178	Single Wall Switch Sensor - PIR White 120-277	10	600	TN
LRS2220/00	-	912400474182	Single Wall Sw Sensor - Multi-Tech White 120-277	10	600	TN
LRM2250/00	662057646183	912400474166	PIR - Ceiling Mnt Sensor Low voltage 1500 sq.ft.	10	240	TN
IRT9090/01	8718291747635	913700359103	Extended IR Programming Tool		1/1040	TN

1. Tested to B50 L70 requirement. LED lifetime means the length of time (in hours) until half of the LED light sources maintain at least 70% of their initial lumen output (B50, L70).

- Stock Ready (returnable)
- Design Ready (non-returnable)





### Why choose Wall Box Dimmers?

- Slide dimming  
– model uses an intuitive, captive slider knob
- Versatile gang configuration  
– model fits in a single-gang box and can be used in multi-gang configurations
- Recommended for executive offices, boardrooms and conference rooms, lobbies, dining rooms and restaurants, retail stores and residential
- UL/CSA listed

### Wall Box Dimmers

Catalog Number	UPC Code	Model Number	Product Description	Case Qty	Pallet Qty	Distribution Center
Indoor Standalone Controls						
SR12002TUNV	912400526434	-	0-10V DIMMER, 120/277V	10	800	TN

## Interact Pro Scalable System

Lights. Insights. Action.

### Why choose Interact Pro Scalable System?

- Get access to energy reporting and diagnostics by simply adding a gateway
- Implement demand response control strategy
- Get access to scheduling capabilities and qualify for more rebates



### Connected Lighting Controls

Catalog Number	UPC Code	Model Number	Product Description	Case Qty	Pallet Qty	Distribution Center
<b>Interact Pro Scalable System</b>						
• SWS200	046677559144	913701046713	Wireless scene switch - Zigbee Green Power switch and scene selector Dim 4B (NA)	-	-	TN
• SBAZ10-CS	-	912401050728	System bridge accessory - 120/277V, 0-10V Dim, Connectable Sensor	-	1/96	PA
■ UID8451/10	46677455439	913700364403	Wireless Dimmer Switch - Zigbee Green Power switch and On/Off/Dim 2 button	20	480	TN
• LCN3120/05	046677558895	913701044013	Occupancy-DL sensor, IA CM IP65, White Finish		10/660	TN
• ER100/00	046677563561	913701057513	Emergency Relay UL924 IA		12/600	TN
<b>Indoor Connected Network Controls</b>						
• LCN1840/05	46677476335	913701037713	Wireless Gateway NA (20 per box)	2	800	TN
• IRT9015	8718696827598	913700396703	Retrofit commissioning device		1/1040	TN
• RFSR10	046677571849	913701057113	Interact Ready RF switch relay		10/270	TN

- Stock Ready (returnable)
- Design Ready (non-returnable)



# Outdoor luminaires

## Stonco

- Area Light
- Dusk to Dawn
- Garage & Canopy
- General Purpose Floods
- LED Bollard
- Low Profile Wall
- LytePro Wall Sconce
- Roughlyte
- Security Light
- Slim Flood
- Tall Wall Pack
- Wall Light
- Wall Pack

## Hadco

- Accent, Line Voltage
- Accent, Low Voltage
- Beacon & Bollard, Conventional
- Deck Lighting, Low Voltage
- Inground, Conventional
- Inground, Low Voltage
- Landscape Lighting Accessories
- Path Lighting, Line Voltage
- Path Lighting, Low Voltage
- Step Lighting
- Underwater, Conventional
- Wall Wash, Line Voltage

## Lumec

- RoadFocus LED Cobra
- Roadway Security Light

## Gardco

- 101L LED Wall Sconce
- EcoForm Family
- SolarForm



## Garage & Canopy Gen2 DualSelect

Compact and efficient, **built to last**

Slim and durable with a lightweight design, this luminaire provides you with a visually appealing lighting experience.



### Why choose Garage & Canopy?

- Field selectable wattage and color temperature
- Cost-effective and efficient lighting for parking garages, covered walkways and canopies
- Slim and compact design
- Durable, weather-tight IP65 rated construction with a rugged, UV stabilized, frosted lens
- Easy to install with the integral quick-mount plate, or pendant mount with 3/4" rigid conduit

### Garage & Canopy DualSelect

Catalog Number	UPC Code	Model Number	Product Description	Compliance	Case/Pallet Qty	Distribution Center
<b>Garage &amp; Canopy DualSelect</b>						
GC60-SCT-G2-SM-5-10-BZ	190096131310	911401872181	Selectable Wattage and CCT 28-40-60W / 3000K-4000K-5000K, Bronze Finish	DLC Standard	5/90	CA, TN, PA
GC90-SCT-G2-SM-5-10-BZ	190096131327	911401872281	Selectable Wattage and CCT 70-80-90W / 3000K-4000K-5000K, Bronze Finish	DLC Standard	5/60	CA, TN, PA
<b>Accessories</b>						
GC60/90-MH10	190096131556	911401828182	MH10 hand-held wireless remote	-	50/1500	TN

- Stock Ready (returnable)
- Design Ready (non-returnable)



## Area Light Gen2 Selectable



**Enhancing a sense of security** for the long haul

Energy-saving technology ideal for pole mounted lighting applications.

### Why choose Area Light?

- Budget-friendly, high quality area lighting for parking and outdoor spaces
- LED technology will save up to 68% energy over HID<sup>1</sup>
- Mounts standard to round or square pole
- Durable aluminum construction
- Lifetime >54,000 hours<sup>2</sup>
- 5-year limited warranty<sup>3</sup>



### Area Light Selectable

Catalog Number	UPC Code	Model No.	Product Description	Comp.	C/P Qty	Distribution Center
<b>Area Light (Arm Mount with Receptacle 3-Pin with shorting cap)</b>						
● AL70-NW-G2-AR-3-8-FAWS-IMRI-TLRD3-BZ	190096180493	912401590706	70W, 70CRI, 4000K, Type 3, 120-277V, Selectable 50-57-65-72W, Bi-level Motion Response, Bronze Finish	DLC Std.	-	Factory
● AL70-NW-G2-AR-3-8-FAWS-TLRD3-BZ	190096180431	912401590699	70W, 70CRI, 4000K, Type 3, 120-277V, Selectable 50-57-65-72W, Bronze Finish	DLC Std.	1/15	CA, TN, PA, GA*
● AL70-NW-G2-AR-4-8-FAWS-IMRI-TLRD3-BZ	190096180516	912401590708	70W, 70CRI, 4000K, Type 4, 120-277V, Selectable 50-57-65-72W, Bi-level Motion Response, Bronze Finish	DLC Std.	-	Factory
● AL70-NW-G2-AR-4-8-FAWS-TLRD3-BZ	190096180455	912401590702	70W, 70CRI, 4000K, Type 4, 120-277V, Selectable 50-57-65-72W, Bronze Finish	DLC Std.	1/15	CA, TN, PA, GA*
● AL70-NW-G2-AR-5-8-FAWS-IMRI-TLRD3-BZ	190096180530	912401590710	70W, 70CRI, 4000K, Type 5, 120-277V, Selectable 50-57-65-72W, Bi-level Motion Response, Bronze Finish	DLC Std.	-	Factory
● AL70-NW-G2-AR-5-8-FAWS-TLRD3-BZ	190096180479	912401590704	70W, 70CRI, 4000K, Type 5, 120-277V, Selectable 50-57-65-72W, Bronze Finish	DLC Std.	-	Factory
● AL150-NW-G2-AR-3-8-FAWS-IMRI-TLRD3-BZ	190096180509	912401590707	150W, 70CRI, 4000K, Type 3, 120-277V, Selectable 95-115-130-145W, Bi-level Motion Response, Bronze Finish	DLC Std.	-	Factory
● AL150-NW-G2-AR-3-8-FAWS-TLRD3-BZ	190096180448	912401590701	150W, 70CRI, 4000K, Type 3, 120-277V, Selectable 95-115-130-145W, Bronze Finish	DLC Std.	1/15	CA, TN, PA, GA*
● AL150-NW-G2-AR-4-8-FAWS-IMRI-TLRD3-BZ	190096180523	912401590709	150W, 70CRI, 4000K, Type 4, 120-277V, Selectable 95-115-130-145W, Bi-level Motion Response, Bronze Finish	DLC Std.	-	Factory
● AL150-NW-G2-AR-4-8-FAWS-TLRD3-BZ	190096180462	912401590703	150W, 70CRI, 4000K, Type 4, 120-277V, Selectable 95-115-130-145W, Bronze Finish	DLC Std.	1/15	CA, TN, PA, GA*
● AL150-NW-G2-AR-5-8-FAWS-IMRI-TLRD3-BZ	190096180547	912401590711	150W, 70CRI, 4000K, Type 5, 120-277V, Selectable 95-115-130-145W, Bi-level Motion Response, Bronze Finish	DLC Std.	-	Factory
● AL150-NW-G2-AR-5-8-FAWS-TLRD3-BZ	190096180486	912401590705	150W, 70CRI, 4000K, Type 5, 120-277V, Selectable 95-115-130-145W, Bronze Finish	DLC Std.	-	Factory
<b>Accessories</b>						
● AL-SF-G2-BZ	190096180639	912401590781	Slip fitter mount accessory	-	12/432	CA, TN, PA, GA*

1. Based on comparison between 250W PSMH (at 295W) and AL-150-NW-G1 at 147W.

2. Predicted performance derived from LED manufacturer's data and engineering design estimates, based on IESNA LM-80 methodology.

3. See [www.signify.com/warranties](http://www.signify.com/warranties) for details.

- Stock Ready (returnable)
- Design Ready (non-returnable)





## Slim Flood

**Illuminate** with discreet and modern style

The best value for discreet and modern design on your floodlighting projects.



### Why choose Slim Flood?

- Complete family of LED floodlights ideal for illuminating signs, building facades or other dark areas
- Can be mounted on the ground, wall, or pole mounted
- All sizes arrive fully assembled and ready to install
- Fade-resistant, textured bronze finish with tempered glass lens that is heat and impact resistant
- IP65 rated, 5-year limited warranty<sup>1</sup>

### Slim Flood

Catalog Number	UPC Code	Model No.	Product Description	Compliance	Case/Pallet Qty	Distribution Center
<b>Slim Flood</b>						
● TF10-CW -G1-K-FL-8-BZ	190096130580	911401810980	10W, 1,000lm, 80CRI, 5000K, Knuckle Mount/Yoke Mount	DLC Standard	18/18	TN
● TF10-NW -G1-K-FL-8-BZ	783352025944	911401733562	10W, 1,000lm, 80CRI, 4000K, Knuckle Mount/Yoke Mount	DLC Standard	18/756	CA, TN, PA
● TF10-WW -G1-K-FL-8-BZ	190096130467	911401809780	10W, 1,000lm, 80CRI, 3000K, Knuckle Mount/Yoke Mount	DLC Standard	18/18	TN
● TF30-CW -G1-K-FL-8-BZ	190096130597	911401811080	30W, 3,000lm, 80CRI, 5000K, Knuckle Mount/Yoke Mount	DLC Standard	10/10	TN
● TF30-NW -G1-K-FL-8-BZ	783352025951	911401733572	30W, 3,000lm, 80CRI, 4000K, Knuckle Mount/Yoke Mount	DLC Standard	10/540	CA, TN, PA
● TF30-WW -G1-K-FL-8-BZ	190096130474	911401809880	30W, 3,000lm, 80CRI, 3000K, Knuckle Mount/Yoke Mount	DLC Standard	10/10	TN
● TF50-CW -G1-K-FL-8-BZ	190096130603	911401811180	50W, 5,000lm, 80CRI, 5000K, Knuckle Mount/Yoke Mount	DLC Standard	6/6	TN
● TF50-NW -G1-K-FL-8-BZ	783352025968	911401733582	50W, 5,000lm, 80CRI, 4000K, Knuckle Mount/Yoke Mount	DLC Standard	6/330	CA, TN, PA, IL
● TF50-WW -G1-K-FL-8-BZ	190096130481	911401809980	50W, 5,000lm, 80CRI, 3000K, Knuckle Mount/Yoke Mount	DLC Standard	6/6	TN, GA*
● TF100-CW -G1-Y-FL-8-BZ	190096130610	911401811280	100W, 10,000lm, 80CRI, 5000K, Yoke Mount	DLC Standard	4/4	TN
● TF100-NW -G1-Y-FL-8-BZ	783352025975	911401733622	100W, 10,000lm, 80CRI, 4000K, Yoke Mount	DLC Standard	4/144	CA, TN, PA
● TF150-CW -G1-Y-FL-8-BZ	190096130627	911401811380	150W, 15,000lm, 80CRI, 5000K, Yoke Mount	DLC Standard	2/2	TN
● TF150-NW -G1-Y-FL-8-BZ	783352025982	911401733632	150W, 15,000lm, 80CRI, 4000K, Yoke Mount	DLC Standard	2/72	CA, TN, PA, IL, GA*
● TF200-CW -G1-Y-FL-8-BZ	190096130634	911401811480	200W, 20,000lm, 80CRI, 5000K, Yoke Mount	DLC Standard	2/2	TN
● TF200-NW -G1-Y-FL-8-BZ	783352025999	911401733642	200W, 20,000lm, 80CRI, 4000K, Yoke Mount	DLC Standard	2/64	CA, TN, PA

1. See [www.signify.com/warranties](http://www.signify.com/warranties) for details.

- Stock Ready (returnable)
- Design Ready (non-returnable)



## General Purpose Floods

Versatile and stylish for a wide range of applications

Offer energy saving LED technology for long life and reduced maintenance.



### Why choose General Purpose Floods?

- Complete family of LED floodlights ideal for illuminating signs, building facades or other dark areas
- Can be mounted on the ground, wall, or pole-mounted
- All sizes arrive fully assembled and ready to install
- Fade-resistant, textured bronze finish with tempered glass lens that is heat and impact resistant
- IP66 rated, 5-year limited warranty<sup>1</sup>



### General Purpose Floods

Catalog Number	UPC Code	Model Number	Product Description	Compliance	Case/Pallet Qty	Distribution Center
<b>General Purpose Floods</b>						
● FL20-NW-G1-K-FL-8-BZ	783352024152	912401467971	20W, 80CRI, 4000K, Knuckle Mount, 120-277V, Bronze Finish	DLC Standard	1/1	TN
● FL20-NW-G1-PCB-K-FL-8-BZ	783352025449	912401477813	20W, 80CRI, 4000K, Knuckle Mount, Photocell, 120-277V, Bronze Finish	DLC Standard	1/1	TN
● FL40-NW-G1-K-FL-8-BZ	783352024169	912401467972	40W, 80CRI, 4000K, Knuckle Mount, 120-277V, Bronze Finish	DLC Standard	1/1	TN, GA*
● FL40-NW-G1-PCB-K-FL-8-BZ	783352025456	912401477814	40W, 80CRI, 4000K, Knuckle Mount, Photocell, 120-277V, Bronze Finish	DLC Standard	1/1	TN
● FL80-NW-G1-PCB-T-FL-8-BZ	783352025463	912401477815	80W, 80CRI, 4000K, Trunion Mount, Photocell, 120-277V, Bronze Finish	DLC Standard	1/1	TN
● FL80-NW-G1-S-FL-8-BZ	783352025364	912401475275	80W, 80CRI, 4000K, Slipfitter Mount, 120-277V, Bronze Finish	DLC Standard	1/1	TN
● FL80-NW-G1-T-FL-8-BZ	783352024176	912401467973	80W, 80CRI, 4000K, Trunion Mount, 120-277V, Bronze Finish	DLC Standard	1/1	TN, GA*
● FL150-NW-G1-PCB-T-FL-8-BZ	783352025487	912401477817	150W, 80CRI, 4000K, Trunion Mount, Photocell, 120-277V, Bronze Finish	DLC Standard	1/1	TN
● FL150-NW-G1-S-FL-8-BZ	783352025166	912401475271	150W, 80CRI, 4000K, Slipfitter Mount, 120-277V, Bronze Finish	DLC Standard	1/1	TN
● FL150-NW-G1-T-FL-8-BZ	783352024183	912401467974	150W, 80CRI, 4000K, Trunion Mount, 120-277V, Bronze Finish	DLC Standard	1/15	TN, GA*
● FL200-NW-G1-S-FL-8-BZ	783352025173	912401475272	200W, 80CRI, 4000K, Slipfitter Mount, 120-277V, Bronze Finish	DLC Standard	1/1	TN
● FL200-NW-G1-T-FL-8-BZ	783352025180	912401475273	200W, 80CRI, 4000K, Trunion Mount, 120-277V, Bronze Finish	DLC Standard	1/1	CA
● FL300-NW-G1-S-FL-8-BZ	783352025197	912401475274	300W, 80CRI, 4000K, Slipfitter Mount, 120-277V, Bronze Finish	DLC Standard	1/1	TN
● FL300-NW-G1-T-FL-8-BZ	783352024190	912401467975	300W, 80CRI, 4000K, Trunion Mount, 120-277V, Bronze Finish	DLC Standard	1/1	TN
<b>Accessories</b>						
■ USF10BRZ	190 096008919	912400470163	Trunion to slipfitter adaptor	-	6/540	TN

1. See [www.signify.com/warranties](http://www.signify.com/warranties) for details.

- Stock Ready (returnable)
- Design Ready (non-returnable)







## Dusk to Dawn Gen3

**Brighten spaces evenly,  
without glare**

A great performing LED light for general purpose areas that fits your budget.



### Why choose Dusk to Dawn?

- Excellent choice for general areas, where lighting can enhance security
- Provides up to 70% energy savings over HID\*
- Refracted lens design spreads light evenly and significantly reduces glare
- Direct mount or arm mount
- Sturdy, fade and abrasion resistant, built of a one-piece die-cast aluminum housing

### Dusk to Dawn

Catalog Number	UPC Code	Model Number	Product Description	Compliance	Case/Pallet Qty	Distribution Center
<b>Dusk to Dawn</b>						
• DTD40-NW-G3-AR-5-TLRPC-1-GY3S	783352025050	912401473420	40W, 80CRI, 4000K, Twist-lock receptacle w/Photocell, Light Grey Finish	DLC Standard	4/48	TN
<b>Accessories</b>						
• DTDARMGY3S	783352024145	912401050002	Mounting Arm for Dust to Dawn, Light Grey Finish	-	10/200	TN

1. DTDLED rated 40 input watts is 70% less versus metal halide systems rated 129 input watts.

- Stock Ready (returnable)
- Design Ready (non-returnable)



## Roughlyte

### Small but mighty

End your search for durable lighting that will really last – a mighty little light with long lasting shine.

VWXL14-NW-G1-8



VCXL14-NW-G1-8

### Why choose Roughlyte?

- Wall or ceiling mounting available
- Provides 83% energy savings over 100W incandescent<sup>1</sup>
- Heat and shock resistant glass globe with cast aluminum guard
- Long life reduces maintenance
- Provides up to 1,390 lumens
- 5-year limited warranty<sup>2</sup>



### Roughlyte

Catalog Number	UPC Code	Model Number	Product Description	Compliance	Case/Pallet Qty	Distribution Center
<b>Roughlyte</b>						
VCXL14-NW-G1-8	783352024770	912401472395	Ceiling Mount, 14W, 80CRI, 4000K, 120-277V, Shot blasted aluminum finish	DLC Standard	1/54	TN
VWXL14-NW-G1-8	783352024787	912401472396	Wall Mount, 14W, 80CRI, 4000K, 120-277V, Shot blasted aluminum finish	DLC Standard	1/60	CA, TN, PA

1. Based on comparison between 100W INC @1710lm and VCXL14 NW-G1 @ 1390lm.  
 2. See [www.signify.com/warranties](http://www.signify.com/warranties) for details.



## Low Profile Wall Light

**Sleek and slim**, with energy saving illumination

Efficacies up to 110 lumens per watt with significant energy savings over HID luminaires.



### Why choose Low Profile Wall Light?

- Budget-friendly, discreet fixture for a wide variety of outdoor spaces
- Energy efficient fixture that delivers up to 110 lumens per watt
- Available in 15W, 30W or 50W
- Slim profile, just over 4 inches
- Durable construction of die-cast aluminum with a UV stabilized lens and stainless steel hardware
- 5-year limited warranty<sup>1</sup>

### Low Profile Wall Light

Catalog Number	UPC Code	Model Number	Product Description	Compliance	Case/Pallet Qty	Distribution Center
<b>Low Profile Wall Light</b>						
● PW15-NW-G1-8-BZ	783352024299	912401468308	15W, 80CRI, 4000K, 120-277V, Bronze Finish	DLC Standard	6/120	PA
● PW30-NW-G1-8-BZ	783352024305	912401468309	30W, 80CRI, 4000K, 120-277V, Bronze Finish	DLC Standard	6/120	PA
● PW50-NW-G1-8-BZ	783352024312	912401468310	50W, 80CRI, 4000K, 120-277V, Bronze Finish	DLC Standard	2/54	PA

1. See [www.signify.com/warranties](http://www.signify.com/warranties) for details.

- Stock Ready (returnable)
- Design Ready (non-returnable)



## Wall Light

Get tough and efficient within your budget

An economical solution for general purpose lighting in an attractive compact form.



SWL-WW-G1-PCB-1-BZ



LWL-WW-G2-PCB-1-BZ

### Why choose Wall Light?

- Wall mount fixture ideal for doorways, entryways and other areas
- Cost-effective enhanced LED performance for an compromised quality for your budget
- Built-in photocell for automatic dusk to dawn lighting offers cost-savings
- Mounts to a standard 4" J-box with a galvanized mounting plate
- One-piece housing with a tough polycarbonate lens
- 5-year limited warranty<sup>1</sup>



### Wall Light

Catalog Number	UPC Code	Model Number	Product Description	Compliance	Case/Pallet Qty	Distribution Center
Wall Light						
SWL-WW-G1-PCB-1-BZ	783352025777	912401479151	SWL Wall Light, 13W, 1100lm, 80CRI, 3000K, Photocell control, 120V, Bronze Finish	-	8/144	CA, TN, PA
LWL-WW-G2-PCB-1-BZ	783352025760	912401479150	LWL Wall Light, 12W, 1100lm, 80CRI, 3000K, Photocell control, 120V, Bronze Finish	-	8/288	CA, TN, PA

1. See [www.signify.com/warranties](http://www.signify.com/warranties) for details.



## Wall Pack Gen2 DualSelect

**Classic design meets  
LED technology**

The new Wall Pack DualSelect helps you upgrade from costly HID fixtures with confidence.



### Why choose Wall Pack?

- An easy switch from costly HID fixture
- Field selectable wattage and color temperature
- Flexible options, built-in photocell, and field enable or disable
- Glass refractor lens design cuts down on glare

### Wall Pack DualSelect

Catalog Number	UPC Code	Model Number	Product Description	Compliance	Case/Pallet Qty	Distribution Center
Wall Pack DualSelect						
● WP100-SCT-G2-10-BZ	190096131341	911401872481	Selectable Wattage and CCT 80-100W / 30K-40K-50K, Bronze Finish	DLC Premium	2/24	CA, TN, PA, IL, GA*
● WP60-SCT-G2-10-BZ	190096131334	911401872381	Selectable Wattage and CCT 28-40-60W / 30K-40K-50K, Bronze Finish	DLC Premium	2/24	CA, TN, PA, IL, GA*

- Stock Ready (returnable)
- Design Ready (non-returnable)



## Tall Wall Pack

Tall, brilliant and **full of life...**

An easy choice for almost any outdoor lighting location with durable illumination that was built to last.



### Why choose Tall Wall Pack?

- Lightweight, compact and built to last
- Provides up to 83% energy savings over 70W Metal Halide luminaires<sup>1</sup>
- The bronze housing is die-cast aluminum and impact resistant polycarbonate, with a frosted lens
- Installation is quick and easy, by mounting to a standard 3.5" or 4" junction box
- Rated for temperatures from -40°C to 40°C



### Tall Wall Pack

Catalog Number	UPC Code	Model Number	Product Description	Compliance	Case/Pallet Qty	Distribution Center
Tall Wall Pack						
• TW20-NW-G1-8-BZ	783352024053	912401468315	20W, 80CRI, 4000K, 120-277V, Bronze Finish	DLC Standard	1/108	TN
• TW20-NW-G1-PCB-1-BZ	783352025104	912401475299	20W, 80CRI, 4000K, Photocell, 120V, Bronze Finish	DLC Standard	6/72	PA

1. Based on comparison between TW20 @ 20W and 70W Metal halide.

- Stock Ready (returnable)
- Design Ready (non-returnable)



## Security Light Selectable

**Motion activated**  
LED security light

Enhance your safety, light when there is need.



### Why choose Security Light?

- Color selectable (30K, 40K, 50K)
- Die-cast aluminum housing with adjustable twin heads
- Motion and photocell control, light up when needed
- IP65 rated, suitable for outdoor application

### Security Light Selectable

Catalog Number	UPC Code	Model Number	Product Description	Compliance	Case/Pallet Qty	Distribution Center
Security Light						
● SL20-SCT-G1-8-BK	190096131303	911401872081	20W, 2000lm, 3000K-4000K-5000K CCT Selectable, 120V, Black Finish	DLC Standard	8/144	CA, TN, PA, IL, GA*

- Stock Ready (returnable)
- Design Ready (non-returnable)



## Lytepro Gen3 Wall Sconce

Designed for projects, **built for stock**

A powerful and precise combination with outstanding energy savings and excellent photometric performance.



### Why choose Lytepro?

- Low-profile design to complement and blend in with surroundings
- Provides energy saving replacement for INC, CFL and HID sources up to 320W
- Optical distributions offer full cutoff performance and an excellent uniformity for precise wall and area illumination
- Easily mounts to a variety of J-box types or fastens directly to wall for seamless retrofitting
- Outstanding value in a compact, architectural design with a long life providing maintenance savings



### Lytepro Wall Sconce

Catalog Number	UPC Code	Model Number	Product Description	Compliance	Case/Pallet Qty	Distribution Center
<b>Lytepro Wall Sconce</b>						
● LPW16-G3-8-BZ	622252813872	912401477098	LPW16, 30W, 4000K, Type 3, 120-277V, Bronze textured paint	DLC Standard	1/84	TN
● LPW16-G3-8-DGY	622252813865	912401477097	LPW16, 30W, 4000K, Type 3, 120-277V, Dark gray textured paint	DLC Standard	1/84	TN
● LPW32-G3-8-BZ	622252813896	912401477101	LPW32, 70W, 4000K, Type 3, 120-277V, Bronze textured paint	DLC Standard	1/63	TN
● LPW32-G3-8-DGY	622252813889	912401477099	LPW32, 70W, 4000K, Type 3, 120-277V, Dark gray textured paint	DLC Standard	1/63	TN
● LPW7-G3-8-BZ	622252813858	912401477096	LPW7, 10W, 4000K, Type 2, 120-277V, Bronze textured paint	DLC Standard	1/450	TN
● LPW7-G3-8-DGY	622252813841	912401477095	LPW7, 10W, 4000K, Type 2, 120-277V, Dark gray textured paint	DLC Standard	1/450	TN
<b>Accessories</b>						
● LPWCVRPLT-BZ	190096011292	912400531043	LPW Universal wall cover mounting plate, Bronze	-	-	PA

- Stock Ready (returnable)
- Design Ready (non-returnable)





## LED Bollard

The path ahead looks clear and bright



### Why choose LED Bollard?

- Clean lines for a timeless, modern look
- Rugged, aluminum construction and high quality finish
- Simple installation
- Silicone gaskets protect internals from harsh elements
- 50,000 hour rated life (L70)

### LED Bollard

Catalog Number	UPC Code	Model Number	Product Description	Compliance	Case/Pallet Qty	Distribution Center
LED Bollard						
● BL25-NW-G1-5-8-BZ	783352025388	912401476167	Bollard, 25W, Type 5	DLC Standard	1/1	PA

- Stock Ready (returnable)
- Design Ready (non-returnable)



## Path Lighting Low Voltage

Creates symmetrical patterns of light for illuminating walkways, steps, and other elevations. Use to show navigation.



### Why choose Low Voltage Path Lighting?

- 12 Volt
- Ships with S7 mounting stake for ease of installation
- toolless relamping
- Die-cast aluminum or spun copper robust housing



### Path Lighting, Low Voltage

Catalog Number	UPC Code	Model Number	Product Description	Case Qty	Pallet Qty	Distribution Center
Path Light Low Voltage, Conventional						
■ CPL12-AS7	783352019653	912400121561	20W T3, Contemporary Path light, Flat Roof w/Stake, 12V, Black	1	60	TN
■ CPL12-HS7	783352019660	912400121564	20W T3, Contemporary Path light, Flat Roof w/Stake, 12V, Bronze	25	200	TN
■ CUL6S7	783352005830	912400121621	20W T3, Path light w/ Stake, Copper	1	60	TN
● CUL7S7	783352001955	912400121629	20W T3, Medium Path light w/ Straight Stem w/ Stake, 12V, Copper	1	60	TN
■ MUL4-AS7	783352008046	912400124595	20W T3, Sm Mushroom w/ lamp, 12V, Black	25	300	TN
■ MUL4-GS7	783352008077	912400124599	20W T3, Sm Mushroom w/ lamp, 12V, Verde	25	300	TN
■ MUL4-HS7	783352002020	912400124604	20W T3, Sm Mushroom w/ lamp, 12V, Bronze	25	200	TN
■ RL4-AS7	783352001948	912400126004	20W T3, Large Horizon, 12V, Black	6	96	TN
■ RL4-HS7	783352009043	912400126008	20W T3, Large Horizon, 12V, Bronze	1	65	TN
■ RL9-AS7	783352019288	912400126051	20W T3, Horizon Path Light With Stake, 12V, Black	1	40	TN
■ RL9-HS7	783352019295	912400126053	20W T3, Horizon Path Light With Stake, 12V, Bronze	16	64	TN
■ GAL3-ACS7	783352019691	912400122613	10W Xenon T3, Garden Art Line Light Contemporary Path light, 12V, Copper	1	50	TN
■ TUL1-GS7	783352014139	912400128658	20W, Small Tulip Path Lite With Stake, 12V, Verde	1	60	CA
Path Light Low Voltage, LED						
■ CUL7-S7LED2W	783352022912	912401335080	12V, LED, Contemporary Path Lite, Roof with Stake, Copper	1	1	TN
■ CPL12-HS7LED2W	783352022851	912401335071	12V, LED, Contemporary Path Lite, Flat Roof with Stake, Bronze	1	60	TN
■ MUL4-AS7LED2W	783352020468	912401335024	12V, LED, Warm 2W T3, Black	1	60	TN
■ MUL4-HS7LED2W	783352020482	912401335026	12V, LED, Warm 2W T3, Bronze	1	60	TN
■ RL4-AS7LED2W	783352020505	912401335028	12V, LED, Warm 2W T3, Black	1	48	TN
■ RL4-HS7LED2W	783352020512	912401335029	12V, LED, Warm 2W T3, Bronze	1	48	TN
■ RL9-AS7LED2W	046677323806	912401335031	12V, LED, Warm 2W T3, Black	1	60	TN

- Stock Ready (returnable)
- Design Ready (non-returnable)





## Path Lighting Line Voltage

Low level, evenly dispersed illumination to highlight plants, flowers, low shrubs and ground cover.



### Why choose Line Voltage Path Lighting?

- 120 Volt
- Die-cast aluminum construction
- Frosted, tempered glass sprinkler shield with molded silicone gaskets
- Thermoset powder coated durable finish

### Path Lighting, Line Voltage

Catalog Number	UPC Code	Model Number	Product Description	Case Qty	Pallet Qty	Distribution Center
Path Light Line Voltage, Conventional						
■ MU5-A	783352001597	912400124587	100W A19, Med Mushroom, 120V, Black	9	180	PA
■ MU5-G	783352001603	912400124589	100W A19, Med Mushroom, 120V, Verde	16	320	TN
■ MU5-H	783352007919	912400124590	100W A19, Med Mushroom, 120V, Bronze	16	320	TN
■ R3-G	783352008909	912400125533	100W A19, Large Indirect, 120V, Verde	1	120	PA

- Stock Ready (returnable)
- Design Ready (non-returnable)



## Accent Lighting Line Voltage

Spot lighting focuses an intense beam of light on a particular subject to showcase focal points.



### Why choose Line Voltage Accent Lighting?

- For projects requiring a system designed to operate utilizing lamping options such as HID, LED or incandescents
- 120 Volts
- 1/2" NPS fitter
- Shrouding and light shielding options available
- Moon lighting simulates the light of a full moon filtering through the foliage of a tree



### Accent Lighting, Line Voltage

Catalog Number	UPC Code	Model Number	Product Description	Case Qty	Pallet Qty	Distribution Center
Accent, Line Voltage						
B4-H	783352003645	912400115703	300W, R40, Large Bullet, 120V, Bronze	1	168	TN
B1-A	783352003485	912400114154	100W, PAR/R20, Small Aluminum Bullet, 120V, Black	1	210	PA
B1-H	783352003515	912400114159	100W, PAR/R20, Small Aluminum Bullet, 120V, Bronze	1	210	PA
B3-H	783352003591	912400115618	100W, PAR/R30, Medium Aluminum Bullet w/ Shroud, 120V, Bronze	1	168	PA
BU3-A	783352005083	912400118972	75W PAR30, Medium Ultem Composite Bullet, 120V, Black	1	168	TN
BU3-G	783352005090	912400118974	75W PAR30, Medium Ultem Composite Bullet, 120V, Verde	1	168	TN
BU3-H	783352005106	912400118978	75W PAR30, Medium Ultem Composite Bullet, 120V, Bronze	1	168	TN
BU1-A	783352005052	912400118964	50W, PAR/R20, Small Ultem Composite Bullet, 120V, Black	1	210	TN
BU1-G	783352005069	912400118966	50W, PAR/R20, Small Ultem Composite Bullet, 120V, Verde	1	210	TN
BU1-H	783352005076	912400118967	50W, PAR/R20, Small Ultem Composite Bullet, 120V, Black	1	210	TN
BU4-A	783352005113	912400118982	100W, Incandescent Composite Bullyte, 120V, Black	1	168	TN
BU4-G	783352005120	912400118983	100W, Incandescent Composite Bullyte, 120V, Verde	1	168	TN
BU4-H	783352005137	912400118984	100W, Incandescent Composite Bullyte, 120V, Bronze	1	168	TN
BUL16-AS7	783352020970	912400119008	35W MR16, Micro Ultem Composite Bullet w/Stake, 12V, Black	1	168	TN
BUL16-GS7	783352020987	912400119015	35W MR16, Micro Ultem Composite Bullet w/Stake, 12V, Verde	1	168	TN
BUL16-HS7	783352020109	912400119021	35W MR16, Micro Ultem Composite Bullet w/Stake, 12V, Bronze	1	168	TN
BL5016-AS7	783352004154	912400118714	50W, MR16, Micro Bullet w/Stake, 12V, Black	1	320	PA
BL5016-HS7	783352004260	912400118753	50W, MR16, Micro Bullet w/Stake, 12V, Bronze	1	320	PA
BL5016-AS7BAB	783352002068	912400118716	20W, MR16, Micro Bullet w/Stake & Lamp, 12V, Black	1	320	TN
BL5016-HS7BAB	783352002150	912400118755	20W, MR16, Micro Bullet w/Stake & Lamp, 12V, Bronze	1	320	TN
BL616-AS7BAB	783352004376	912400118784	20W, MR16, Micro Bullet w/Stake & Lamp, 12V, Black	1	320	TN
BL616-HS7BAB	783352004482	912400118796	20W, MR16, Micro Bullet W/Stake & Lamp, 12V, Bronze	1	320	TN

- Stock Ready (returnable)
- Design Ready (non-returnable)





## Accent Lighting LED Line Voltage

This accent landscape luminaire has interchangeable 20°, 36° and 65° optics by switching lenses.



### Why choose LED Line Voltage Accent Lighting?

- Narrow, medium and wide flood beam patterns, interchangeable via snap-on lenses
- Standard 0-10V dimming
- Five field adjustable lumen outputs

### Accent Lighting, LED Line Voltage

Catalog Number	UPC Code	Model Number	Product Description	Case Qty	Pallet Qty	Distribution Center
Accent, Line Voltage						
■ B9DC-A	662057949994	912400537464	120V, LED, Cool, Large Architectural Accent LED, Black Finish	1	100	TN
■ B9DC-H	662057950006	912400537465	120V, LED, Cool, Large Architectural Accent LED, Bronze Finish	1	100	TN
■ B9DW-A	662057949970	912400537462	120V, LED, Warm, Large Architectural Accent LED, Black Finish	1	100	TN
● B9DW-H	783352022783	912400537463	120V, LED, Warm, Large Architectural Accent LED, Bronze Finish	1	168	PA

- Stock Ready (returnable)
- Design Ready (non-returnable)



## Accent Lighting LED Low Voltage

### The all-in-one solution for landscape lighting.

Imagine the convenience and cost savings of having different light levels and a variety of beam patterns, all within a single LED luminaire.

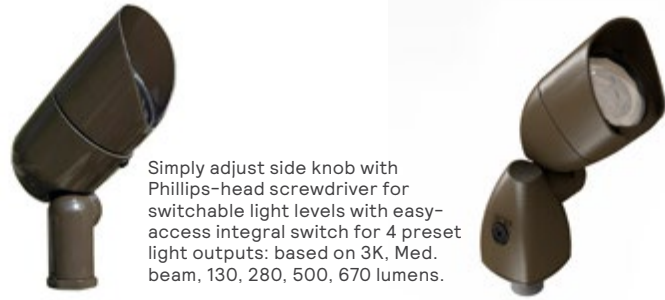

Simply adjust side knob with Phillips-head screwdriver for switchable light levels with easy-access integral switch for 4 preset light outputs: based on 3K, Med. beam, 130, 280, 500, 670 lumens.

### Why choose LED Low Voltage Accent Lighting?

- Beam adjustable lens that zooms from narrow (15°) to medium (30°) beam, with easy removal via twist-off shroud
- Interchangeable flood (60°) lens included
- Adjustable knuckle arm for precise aiming to a range of 150°
- Vibration locking teeth secured by black SS screw



### Accent Lighting, LED Low Voltage

Catalog Number	UPC Code	Model Number	Product Description	Case Qty	Pallet Qty	Distribution Center
Accent LED, Low Voltage						
BL5016-AS7LED7FLW	783352017079	912400118722	12V, LED, Warm, 7 Watts, Flood, Micro Bullet W/Stake, Black	1	320	PA
BL5016-AS7LED7NFW	783352016997	912400118725	12V, LED, Warm, 7 Watts, Narrow Flood, Micro Bullet W/Stake, Black	1	320	TN
BL5016-HS7LED7FLW	783352017093	912400118763	12V, LED, Warm, 7 Watts, Flood, Micro Bullet W/Stake, Bronze	1	320	TN
BL5016-HS7LED7NFW	783352017017	912400118765	12V, LED, Warm, 7 Watts, Narrow Flood, Micro Bullet W/Stake, Bronze	1	320	TN
BL9DC-AS7	783352020826	912401150003	12V, LED, Cool, Small Architectural Accent LED, FlexScape, Black	1	336	TN
BL9DC-HS7	783352020833	912401150004	12V, LED, Cool, Small Architectural Accent LED, FlexScape, Bronze	28	336	TN
BL9DW-AS7	783352020802	912401150001	12V, LED, Warm, Small Architectural Accent LED, FlexScape, Black	1	320	PA
BL9DW-HS7	783352020819	912401150002	12V, LED, Warm, Small Architectural Accent LED, FlexScape, Bronze	1	168	PA

- Stock Ready (returnable)
- Design Ready (non-returnable)



## Beacons & Bollards

Creates symmetrical patterns of light for illuminating walkways, steps, and other elevations. Use to show navigation.



### Why choose Beacons & Bollards?

- Ensures long-lasting durability
- Tightly sealed protection
- Highly weather-resistant
- 25,000 hour life with LEDs
- Die-cast aluminum dome and louvers
- Walkway application

### Beacon & Bollard

Catalog Number	UPC Code	Model Number	Product Description	Case Qty	Pallet Qty	Distribution Center
<b>Beacon</b>						
1010-H	783352002266	912400104302	120V, 100W, A19, Beacons, Bronze	1	100	PA
DWCL2-A	783352006240	912400121909	12V, 20W,T3, Composite Semi Recessed Beacon, Black	1	168	PA
<b>Bollard</b>						
DB14-H	783352014825	912400121673	120V, 100W INC, Round Top Bollard, 14", Bronze	1	72	PA
DB30-A	783352020772	912400121701	120V, 100W INC, 100W INC Round Top Bollard, 30", Black	1	24	TN
DB30-H	783352014832	912400121702	120V, 100W INC, 100W INC Round Top Bollard,30", Bronze	1	24	TN
<b>Bollard LED</b>						
DB30AA012LE	190096019700	912400121711	120V, LED, Warm, 11W, Clear Symmetric, Round Top Bollard, 30",Black	1	24	CA
DB30HA012LE	190096019717	912400121724	120V, LED, Warm, 11W, Clear Symmetric, Round Top Bollard, 30", Bronze	1	24	TN

- Stock Ready (returnable)
- Design Ready (non-returnable)

# Deck Lighting Low Voltage

illuminating deck floors and steps while enhancing design and outdoor living spaces.



## Why choose Low Voltage Deck Lighting?

- Consider placing fixtures under built in benches for a clean, inconspicuous look. When placing under handrails, mount fixtures high enough for good light distribution but be careful not to see the source when seated



### Deck Lighting, Low Voltage

Catalog Number	UPC Code	Model Number	Product Description	Case Qty	Pallet Qty	Distribution Center
<b>Deck Conventional, Low Voltage</b>						
DAL1-A	783352002099	912401290001	Decklyte, AL,12V,10W,31002058	25	1000	TN
DAL1-H	783352001993	912401290004	Decklyte, AL,12V,10W,31002058	25	1000	TN
DUL1-H	783352006196	912401290008	Decklyte, COMPOSITE,12V,10W,T3	1	660	TN
<b>Deck LED, Low Voltage</b>						
DAL1-ALED2W	046677323776	912401335011	12V, LED, Deck Light, Aluminum, Warm 2W T3, Black	1	630	TN
DAL1-HLED2W	046677323790	912401335014	12V, LED, Deck Light, Aluminum, Warm 2W T3, Bronze	1	280	TN
DUL1-HLED2W	190096019731	912401335017	12V, LED, Deck Light, Ultem, Warm 2W T3, Bronze	1	320	TN

● Stock Ready (returnable)  
■ Design Ready (non-returnable)





## Inground Lighting

Creating visual interest or pathways, walls, columns and foliage. Its rugged housing installs directly into the soil.



### Why choose Inground Lighting?

- Ensures long-lasting durability
- Adjustable height and angle
- Increased design flexibility
- Quick and easy installation
- Rugged construction
- Lampholder contains integral fins

### Inground Lighting

Catalog Number	UPC Code	Model Number	Product Description	Case Qty	Pallet Qty	Distribution Center
Inground						
IL336-A	783352000149	912400123068	12V, 50W PAR 36, Well Light, Black	1	168	PA
IUL516-H	783352007254	912400123116	12V, 35W MR16, Ultem Micro Inground, MR16, Bronze	1	210	TN

- Stock Ready (returnable)
- Design Ready (non-returnable)



# Inground Lighting LED Low Voltage

The FlexScape LED inground luminaire IL9 is designed for optimal LED performance and superior flexibility. It creates visual interest for pathways, walls, columns and foliage. Its rugged housing installs directly into the soil.



## Why choose LED Low Voltage Inground Lighting?

- Competitively priced outdoor lighting offers performance and versatility
- 100% molded silicone gaskets
- Convenient onsite beam adjustability
- CCT: 3000K and 4000K
- CRI: 70
- Wattage: 12W (max)
- Voltage: 12V typical (10.5V-15V)
- 50,000 hour rated life (L70)



### Inground Lighting, LED Low Voltage

Catalog Number	UPC Code	Model Number	Product Description	Case Qty	Pallet Qty	Distribution Center
Inground LED, Low Voltage						
■ IL9DC-A	783352021595	912401150006	12V, LED, Cool, Zoomable Optics, FlexScape, Black	1	336	CA
● IL9DW-A	783352021588	912401150005	Inground, Low Voltage	1	168	PA



## Step Lighting

The RSC2 is a line voltage step light perfect for high pedestrian traffic and plant life applications.



### Why choose Step Lighting?

- Corrosion-resistant
- Cool external temperatures
- Ability to shield the light source
- Available with conventional and LED technology
- Silicone gasket
- Symmetric reflector

### Step Lighting

Catalog Number	UPC Code	Model Number	Product Description	Case Qty	Pallet Qty	Distribution Center
<b>Step Light Conventional</b>						
RSC2HK5IE	783352010995	912400126294	120V, 40W T10 (K5IE), Louvered Brick light, Bronze	1	168	PA
<b>Step Light LED</b>						
RSC2AK5DG2	783352023148	912401488069	BrickLyte, 120-277V, LED, Black	1	224	TN
RSC2HK5DG2	783352023162	912401488073	BrickLyte, 120-277V, LED, Bronze	1	120	PA

- Stock Ready (returnable)
- Design Ready (non-returnable)

# Underwater Lighting

Built to last with injection molded fiberglass reinforced Ultem High Performace Polymer, the UWUL516 composite underwater fixture delivers signature engineering and durable construction.



## Why choose Underwater Lighting?

- Superior durability
- Ultimate protection
- One-piece, injection molded construction
- Silicone gasket



### Underwater Lighting

Catalog Number	UPC Code	Model Number	Product Description	Case Qty	Pallet Qty	Distribution Center
Underwater						
UWUL516-H	783352014337	912400128719	Underwater, Micro, 12v, 35w, MR16	1	168	TN

- Stock Ready (returnable)
- Design Ready (non-returnable)



IP66 rated

## Wall Wash Lighting LED Line Voltage

An LED flood light delivering 50,000 hours of operating life, has a CCT of 3,000K or 4,000K and a CRI of 80.



### Why choose LED Line Voltage Wall Wash Lighting?

- Able to direct light with ultimate precision
- Warm or cool color temperatures available
- Completely dust tight and sealed against direct jets of water
- Fade and abrasion resistant
- Offers 50,000 hour life with LED
- Die cast aluminum housing
- Fully-adjustable swivel arm with vibration-proof locking teeth

### Wall Wash Lighting, LED Line Voltage

Catalog Number	UPC Code	Model Number	Product Description	Case Qty	Pallet Qty	Distribution Center
Wall Washer, Line Voltage						
■ WAM1DCG2-H	783352023223	912401488091	MiniFlood, LED, G2, Clear, LVR, Bronze	1	216	PA
■ WAM1DFG2-H	783352023193	912401488094	MiniFlood, LED, G2, Frost, LVR, Bronze	20	160	PA

- Stock Ready (returnable)
- Design Ready (non-returnable)



## Landscape Lighting Accessories

Power supply, mounting accessories and other tools to help install and maintain your landscape lighting system.



### Why choose Landscape Lighting Accessories?

- Stainless steel or painted transformers
- Mounting canopy for wall or tree mounting
- Ground installation stakes



### Landscape Lighting Accessories

Catalog Number	UPC Code	Model Number	Product Description	Case Qty	Pallet Qty	Distribution Center
1HSO	783352002518	912400105338	Short Shroud (B1), Bronze	1	660	TN
4HSO	783352002945	912400112687	Short Shroud (B4), Bronze	1	210	Factory
BI2	783352003690	912400118662	Cast Iron Box (3/4" NPT)	216	216	CA
BI3	783352001573	912400118663	Cast Iron Box w/four 1/2" NPT+ two 1/2" NPT	216	216	PA
BI4	783352003706	912400118664	Cast Iron Box w/two 1/2" NPT+ two 1/2" NPT	216	216	PA
CP5	783352000408	912400121332	Concrete Pour Kit, IUL516 & IL9	1	210	CA
LVC3	783352002037	912400123922	Connectors (Box of 12)	1	800	TN
LVC4	783352007360	912400123923	Low Voltage "T" Connector	1	800	TN
MAKM	783352001979	912400124528	Mounting Kit for in Masonry,	100	1800	PA
MC1A	783352001757	912400124531	LV Mounting Canopy (Box of 6), Black	150	2400	CA
MC1H	783352007490	912400124534	LV Mounting Canopy (Box of 6), Bronze	200	2400	TN
RS2-HHO	783352010117	912400126190	HSG Only for RSB2/RSC2/RSF2, Bronze	1	168	TN
S24G	783352012074	912400126875	24" Stem, Verde	120	1440	CA
S3A	783352012203	912400127018	Perma-Post 3" O.D. (Box of 12), Black	12	360	CA
S3G	783352012227	912400127020	Perma-Post 3" O.D. (Box of 12), Verde	12	360	TN
S3H	783352012234	912400127021	Perma-Post 3" O.D. (Box of 12), Bronze	12	360	TN
S7	783352001825	912400127422	Low Voltage Mounting Stake (Box of 12)	200	3000	TN
TM1H	783352013668	912400128612	Tree Mount Canopy, Bronze	200	2400	TN
TM2H	783352001726	912400128616	Tree Mount Junction Box	48	576	TN
TMC2H	783352001733	912400128621	Tree Mount.Composite	1	360	TN
PC3	783352001818	912400125335	Plug-In Photo Cell, Direct Mount	1	800	TN
TSS654-15	783352015013	912400128647	Transformer, 600VA/600W, Hingd Door	1	32	TN
TC354-15	783352015051	912400128428	Transformer, 300VA/300W, Hingd Door	1	32	PA
TSS354-15	783352015006	912400128644	Power Supply, 300W	1	32	CA, TN
TC152-12	783352015037	912400128425	150VA/150W Transformer, Grey	1	120	PA
TC152-12TP	783352015044	912400128427	150VA-150W Transformer w/Eye+Timer	1	60	CA, TN

- Stock Ready (returnable)
- Design Ready (non-returnable)





## Roadway Security Lighting

Security made simple and affordable



### Why choose Roadway Security Light?

- Comes controls-ready out of the box with dimming driver and 7-pin receptacle
- 3000K and 4000K color temperatures available
- Type 3 and 5 optics
- IP66 rated LED module
- 5-year limited warranty<sup>1</sup>

### Roadway Security Lighting

Catalog Number	UPC Code	Model Number	Product Description	Compliance	Case/Pallet Qty	Dist. Center
Roadway Security Lighting						
■ RSLM-70W-730-G1-5-UNV-DMG-TLRD7-GY3	190096180912	828820210710	Medium, 3000K, Type 5	DLC Premium	2/32	-
■ RSLM-70W-730-G1-R3M-UNV-DMG-TLRD7-GY3	-	828820210708	Medium, 3000K, Type 3 Medium	DLC Premium	2/32	-
■ RSLM-70W-740-G1-5-UNV-DMG-TLRD7-GY3	190096180905	828820210709	Medium, 4000K, Type 5	DLC Premium	2/32	-
■ RSLM-70W-740-G1-R3M-UNV-DMG-TLRD7-GY3	190096180882	828820210707	Medium, 4000K, Type 3 Medium	DLC Premium	2/32	-
■ RSLS-40W-730-G1-5-UNV-DMG-TLRD7-GY3	190096180875	828820210706	Small, 3000K, Type 5	DLC Premium	4/32	-
■ RSLS-40W-730-G1-R3M-UNV-DMG-TLRD7-GY3	-	828820210704	Small, 3000K, Type 3 Medium	DLC Premium	4/32	-
■ RSLS-40W-740-G1-5-UNV-DMG-TLRD7-GY3	190096180868	828820210705	Small, 4000K, Type 5	DCL Premium	4/32	-
■ RSL-40W-740-G1-R3M-UNV-DMG-TLRD7-GY3	190096180844	828820210703	Small, 4000K, Type 3 Medium	DLC Premium	4/32	-
Accessories						
● ACC-RSLM-PSL	784197656652	912401494525	Prismatic Lens for Roadway Security Light Medium	-	10/200	CA, TN, PA
● ACC-RSLS-PSL	784197656645	912401494524	Prismatic Lens for Roadway Security Light Small	-	10/200	CA, TN, PA
● ACC-RSLS-RSLM-ARM	784197656669	912401494526	Mounting arm with hardware	-	2/20	CA, TN, PA

1. See [www.signify.com/warranties](http://www.signify.com/warranties) for details.

- Stock Ready (returnable)
- Design Ready (non-returnable)



## RoadFocus LED Cobra

Enhance your Roadway

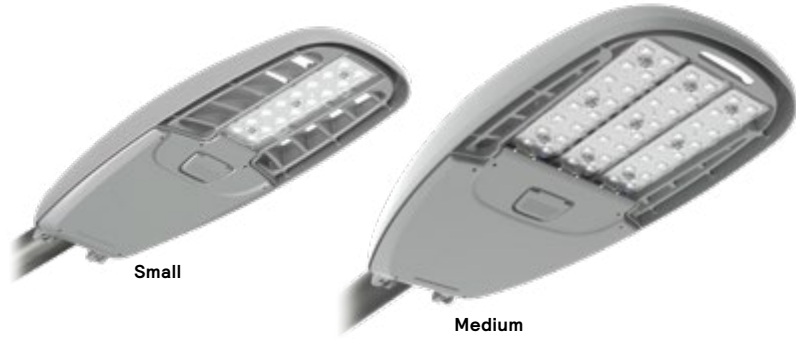

### Why choose RoadFocus LED Cobra?

- Provides uniform, high performance illumination
- Type 2M and 3M distributions
- IP66 Rated Light Engines
- Signify's exclusive Service Tag included



### RoadFocus LED Cobra

Catalog Number	UPC Code	Model Number	Product Description	Compliance	Case/Pallet Qty	Dist. Center
RFM-108W48LED4K-G2-R2M-UNV-DMG-RCD7-GY3	190096077250	912400546036	Medium, 108 Watt, 48LED, 4000K, Type 2 Medium	DLC Premium	1/40	-
RFM-108W48LED4K-G2-R3M-UNV-DMG-RCD7-GY3	190096062072	912400544404	Medium, 108 Watt, 48 LED, 4000K, Type 3 Medium	DLC Premium	1/40	-
RFS-45W16LED4K-G2-R2M-UNV-DMG-RCD7-GY3	190096168408	912400553542	Small, 45 Watt, 16LED, 4000K, Type 2 Medium	DCL Premium	1/50	-
RFS-45W16LED4K-G2-R3M-UNV-DMG-RCD7-GY3	190096096237	912400548287	Small, 45 Watt, 16LED, 4000K, Type 3 Medium	DLC Premium	1/50	-
RFS-54W16LED3K-G2-R2M-UNV-DMG-RCD7-GY3	190096060719	912400544353	Small, 54 Watt, 16 LED, 3000K, Type 2 Medium	DLC Premium	1/50	-
RFS-54W16LED3K-G2-R3M-UNV-DMG-RCD7-GY3	190096080625	912400546428	Small, 54 Watt, 16 LED, 3000K, Type 3 Medium	DLC Premium	1/50	-
RFS-54W16LED4K-G2-R2M-UNV-DMG-RCD7-GY3	190096077632	912400546057	Small, 54 Watt, 16 LED, 4000K, Type 2 Medium	DCL Premium	1/50	-
RFS-54W16LED4K-G2-R3M-UNV-DMG-RCD7-GY3	190096062065	912400544403	Small, 54 Watt, 16LED, 4000K, Type 3 Medium	DLC Premium	1/50	-

- Stock Ready (returnable)
- Design Ready (non-returnable)





# EcoForm Family Gen2

Deliver more than expected



## Why choose EcoForm?

- Deliver optimum light levels without over- or under-lighting with true 400W and 1000W HID equivalency
- Stylized, one piece die-cast aluminum housing with built in heat sink
- Standard arm mount, retrofit arm mount, slipfitter mount and wall mount available
- IP66 rated optical assembly and IP65 rated electrical housing



## EcoForm Family

Catalog Number	UPC Code	Model Number	Product Description	Compliance	Case/Pallet Qty	Distribution Center
EcoForm						
■ RS-ECF-S-32L-1A-NW-G2-AR-3-UNV-BK	190096185504	912401534554	Small, Type 3, 105W, 32 LED, 4000K, Arm Mount, 120-277V, Black	DLC Standard	1/14	Factory
■ RS-ECF-S-32L-1A-NW-G2-AR-3-UNV-BZ	190096018062	912401466002	Small, Type 3, 105W, 32 LED, 4000K, Arm Mount, 120-277V, Bronze	DLC Standard	-	Factory
■ RS-ECF-S-32L-1A-NW-G2-AR-3-UNV-MGY	190096018079	912401466003	Small, Type 3, 105W, 32 LED, 4000K, Arm Mount, 120-277V, Medium Grey	DLC Standard	-	Factory
■ RS-ECF-S-32L-1A-NW-G2-AR-4-UNV-BK	190096183784	912401534555	Small, Type 4, 105W, 32 LED, 4000K, Arm Mount, 120-277V, Black	DLC Standard	1/14	Factory
■ RS-ECF-S-32L-1A-NW-G2-AR-4-UNV-BZ	190096018086	912401466004	Small, Type 4, 105W, 32 LED, 4000K, Arm Mount, 120-277V, Bronze	DLC Standard	-	Factory
■ RS-ECF-S-32L-1A-NW-G2-AR-4-UNV-MGY	190096018093	912401466005	Small, Type 4, 105W, 32 LED, 4000K, Arm Mount, 120-277V, Medium Grey	DLC Standard	-	Factory
■ RS-ECF-S-32L-1A-NW-G2-AR-5-UNV-BK	190096183777	912401534556	Small, Type 5, 105W, 32 LED, 4000K, Arm Mount, 120-277V, Black	DLC Standard	1/14	Factory
■ RS-ECF-S-32L-1A-NW-G2-AR-5-UNV-BZ	190096018109	912401466006	Small, Type 5, 105W, 32 LED, 4000K, Arm Mount, 120-277V, Bronze	DLC Standard	-	Factory
■ RS-ECF-S-32L-1A-NW-G2-AR-5-UNV-MGY	190096018116	912401466007	Small, Type 5, 105W, 32 LED, 4000K, Arm Mount, 120-277V, Medium Grey	DLC Standard	-	Factory
■ RS-ECF-S-48L-1A-NW-G2-AR-3-UNV-BK	190096184583	912401534557	Small, Type 3, 155W, 48 LED, 4000K, Arm Mount, 120-277V, Black	DLC Standard	1/14	Factory
■ RS-ECF-S-48L-1A-NW-G2-AR-3-UNV-BZ	190096018123	912401466008	Small, Type 3, 155W, 48 LED, 4000K, Arm Mount, 120-277V, Bronze	DLC Standard	-	Factory
■ RS-ECF-S-48L-1A-NW-G2-AR-3-UNV-MGY	190096018130	912401466009	Small, Type 3, 155W, 48 LED, 4000K, Arm Mount, 120-277V, Medium Grey	DLC Standard	-	Factory
■ RS-ECF-S-48L-1A-NW-G2-AR-4-UNV-BK	190096184408	912401534558	Small, Type 4, 155W, 48 LED, 4000K, Arm Mount, 120-277V, Black	DLC Standard	1/14	Factory
■ RS-ECF-S-48L-1A-NW-G2-AR-4-UNV-BZ	190096018147	912401466010	Small, Type 4, 155W, 48 LED, 4000K, Arm Mount, 120-277V, Bronze	DLC Standard	-	Factory
■ RS-ECF-S-48L-1A-NW-G2-AR-4-UNV-MGY	190096018154	912401466011	Small, Type 4, 155W, 48 LED, 4000K, Arm Mount, 120-277V, Medium Grey	DLC Standard	-	Factory
■ RS-ECF-S-48L-1A-NW-G2-AR-5-UNV-BK	190096187836	912401534559	Small, Type 5, 155W, 48 LED, 4000K, Arm Mount, 120-277V, Black	DLC Standard	1/14	Factory
■ RS-ECF-S-48L-1A-NW-G2-AR-5-UNV-BZ	190096018161	912401466012	Small, Type 5, 155W, 48 LED, 4000K, Arm Mount, 120-277V, Bronze	DLC Standard	-	Factory
■ RS-ECF-S-48L-1A-NW-G2-AR-5-UNV-MGY	190096018178	912401466013	Small, Type 5, 155W, 48 LED, 4000K, Arm Mount, 120-277V, Medium Grey	DLC Standard	-	Factory

- Stock Ready (returnable)
- Design Ready (non-returnable)

# EcoForm Family Gen2

(continued)

Catalog Number	UPC Code	Model Number	Product Description	Compliance	Case/Pallet Qty	Distribution Center
EcoForm (continued)						
■ RS-ECF-S-64L-1A-NW-G2-AR-3-UNV-BK	190096187843	912401534560	Small, Type 3, 212W, 64 LED, 4000K, Arm Mount, 120-277V, Black	DLC Standard	1/14	Factory
■ RS-ECF-S-64L-1A-NW-G2-AR-3-UNV-BZ	190096018185	912401466014	Small, Type 3, 212W, 64 LED, 4000K, Arm Mount, 120-277V, Bronze	DLC Standard	-	Factory
■ RS-ECF-S-64L-1A-NW-G2-AR-3-UNV-MGY	190096018192	912401466015	Small, Type 3, 212W, 64 LED, 4000K, Arm Mount, 120-277V, Medium Grey	DLC Standard	-	Factory
■ RS-ECF-S-64L-1A-NW-G2-AR-4-UNV-BK	190096188123	912401534561	Small, Type 4, 212W, 64 LED, 4000K, Arm Mount, 120-277V, Black	DLC Standard	1/14	Factory
■ RS-ECF-S-64L-1A-NW-G2-AR-4-UNV-BZ	190096018208	912401466016	Small, Type 4, 212W, 64 LED, 4000K, Arm Mount, 120-277V, Bronze	DLC Standard	-	Factory
■ RS-ECF-S-64L-1A-NW-G2-AR-4-UNV-MGY	190096018215	912401466017	Small, Type 4, 212W, 64 LED, 4000K, Arm Mount, 120-277V, Medium Grey	DLC Standard	1/1	Factory
■ RS-ECF-S-64L-1A-NW-G2-AR-5-UNV-BK	190096188116	912401534562	Small, Type 5, 212W, 64 LED, 4000K, Arm Mount, 120-277V, Black	DLC Standard	1/14	Factory
■ RS-ECF-S-64L-1A-NW-G2-AR-5-UNV-BZ	190096018222	912401466018	Small, Type 5, 212W, 64 LED, 4000K, Arm Mount, 120-277V, Bronze	DLC Standard	1/1	Factory
■ RS-ECF-S-64L-1A-NW-G2-AR-5-UNV-MGY	190096018239	912401466019	Small, Type 5, 212W, 64 LED, 4000K, Arm Mount, 120-277V, Medium Grey	DLC Standard	-	Factory
Accessories						
■ RS-ECF-RAM-G2-DGY	190096155088	912401466487	Gen-2, Retrofit Arm Mount Accessory, Dark Grey Finish	-	-	Factory
■ RS-ECF-RAM-G2-MGY	190096155095	912401466488	Gen-2, Retrofit Arm Mount Accessory, Medium Grey Finish	-	-	Factory
■ RS-ECF-RAM-G2-WH	190096155187	912401466485	Gen-2, Retrofit Arm Mount Accessory, White Finish	-	-	Factory
■ RS-HIS-32-H	190096155194	912401466489	Gen-2, Internal Shields for 32 LED standard configuration	-	-	Factory
■ RS-HIS-48-H	190096155200	912401466491	Gen-2, Internal Shields for 48 LED standard configuration	-	-	Factory
■ RS-HIS-64-H	190096155217	912401466493	Gen-2, Internal Shields for 64 LED standard configuration	-	-	Factory
● 443560018450	190096019861	912400215786	3/4-18-3.75 A/B 2N-2W-1L	-	375/1500	CA, TN, PA
● 443560020760	190096019878	912400214158	5/8-18-3.62 A/B 2N-2W-1LW (4 PER POLE)	-	375/1500	PA
● 1-36-45	190096019885	912400215784	1-36-4.5 A/B 2N-2W-1LW(4/POLE)	-	500/500	TN

# 101L LED Wall Sconce

Offering the most diverse  
line of performance sconces



## Why choose 101L LED Wall Sconce?

- Uses up to 50% less energy than HID
- Uniform distribution free of hot spots, streaks or striations
- Maintains long LED life
- Meets zero uplight criteria
- IP66 rated optics



### 101L LED Wall Sconce

Catalog Number	UPC Code	Model Number	Product Description	Compliance	Distribution Center
101L LED Wall Sconce					
■ RS-101L-16L-700-NW-G1-3-UNV-BZ	190096155002	912401472920	16 LED @ 700ma, 4000K, Type 3, 120-277V, Bronze	DLC Standard	Factory
■ RS-101L-16L-700-NW-G1-3-UNV-MGY	190096155019	912401472921	16 LEDs @ 700ma, 4000K, Type 3, 120-277V, Medium Grey	DLC Standard	Factory
■ RS-101L-16L-700-NW-G1-4-UNV-BZ	190096155026	912401472922	16 LED @ 700ma, 4000K, Type 4, 120-277V, Bronze	DLC Standard	Factory
■ RS-101L-16L-700-NW-G1-4-UNV-MGY	190096155033	912401472923	16 LEDs @ 700ma, 4000K, Type 4, 120-277V, Medium Grey	DLC Standard	Factory
■ RS-101L-32L-530-NW-G1-3-UNV-BZ	190096155040	912401472924	32 LEDs @ 530ma, 4000K, Type 3, 120-277V, Bronze	DLC Standard	Factory
■ RS-101L-32L-530-NW-G1-3-UNV-MGY	190096155057	912401472925	32 LEDs @ 530ma, 4000K, Type 3, 120-277V, Medium Grey	DLC Standard	Factory
■ RS-101L-32L-530-NW-G1-4-UNV-BZ	190096155064	912401472926	32 LEDs @ 530ma, 4000K, Type 4, 120-277V, Bronze	DLC Standard	Factory
■ RS-101L-32L-530-NW-G1-4-UNV-MGY	190096155071	912401472927	32 LEDs @ 530ma, 4000K, Type 4, 120-277V, Medium Grey	DLC Standard	Factory

- Stock Ready (returnable)
- Design Ready (non-returnable)



# SolarForm

All-in-one solar area light for off-grid applications



## Why choose SolarForm?

- Brings light to areas without access to electric grid
- Sturdy construction for long life
- Environment friendly
- Preserves landscape as no trenching for cabling required
- Saves energy

### SolarForm

Catalog Number	Model Number	Product Description	Case Qty	Pallet Qty	Dist. Center
SolarForm					
BRP710 LED45 NW MR SI 12V LFP Solar	919515813569	All-in-One Solar Solution, 4000K, 3000 lumens, IES Type 2, Motion Sensor, Dimming Profile 2	1	1	TN
BRP710 LED45 NW MR SI 12V FD30 Solar	919515813571	All-in-One Solar Solution, 4000K, 4500 lumens, IES Type 2, Dimming Profile 4	1	1	TN
BRP710 LED30 NW MR 12V LFP AIO Solar	919515812983	All-in One Solar Solution, 4000K, 3000 lumens, IES Type 2, Motion Sensor, Dimming Profile 2	1	1	TN

- Stock Ready (returnable)
- Design Ready (non-returnable)

# Retrofit & LED lamps

## Philips retrofits

- EvoKit Click

## Philips lamps

- Candles B11/BA11 & F15
- CorePro A-Shape
- CorePro FlexFit (Type A+B)
- CorePro GU10 & MR16
- CorePro High Bay/Low Bay
- CorePro InstantFit (Type A/C)
- CorePro Corn Cob
- CorePro MainsFit (Type B)
- CorePro PAR
- CorePro Party A19 & PAR
- CorePro PLED
- CorePro Wall Packs
- Decorative A15 & S14
- Globes G16.5 & G25
- MasterClass A-Shape
- MasterClass AR111
- MasterClass Designer
- MasterClass ExpertColor PAR
- MasterClass InstantFit (Type A/C)
- MasterClass Corn Cob
- MasterClass Corn Cob with Selectable CCT
- MasterClass MainsFit (Type B)
- MasterClass MR16
- MasterClass Specialty
- MasterClass TrueForce PAR
- Reflectors
- Title 20 MR16
- Title 20 PAR
- TrueForce High Bay
- TrueForce Post Top
- UFO
- UniversalFit



Sleek and modern look for a refreshed space



### Why choose EvoKit Click LED Retrofit kits?

- Integrated light engine enables easy maintenance and future upgradeability from below ceiling without tools
- High efficacy/low wattage for maximum rebates and energy savings
- Fits most 2x4 and 2x2 troffers (grid/narrow grid)
- Control options for maximum flexibility

### EvoKit Click LED Retrofit kits

Catalog Number	Model Number*	UPC Code	Product Description	Compliance	Lms.	Dimming	Volts	Watts	Eff.	CRI (min.)	CCT (K)	DLC ID	C/P Qty	Lifespan (hrs)	Dist. Center
<b>EvoKit Click 2' x 2'</b>															
523621	929001777713	781087162040	2x2 32L 24W 835 UNV 0-10 P4	DLC Premium	3200	0-10V	120-277	24	133	80	3500	PBBL99UF	4/84	70,000	CA, TN, PA
523647	929001777913	781087162064	2x2 32L 24W 840 UNV 0-10 P4	DLC Premium	3200	0-10V	120-277	24	138	80	4000	PCGIVN5U	4/84	70,000	CA, TN, PA
523464	929001776313	781087161906	2x2 32L 24W 835 UNV SWZ P1	DLC Premium	3200	SpaceWise DT	120-277	24	133	80	3500	PIT3B0KJ	1/55	70,000	CA, TN, PA
523878	929001780213	781087162293	2x2 32L 24W 840 UNV SWZ P4	DLC Premium	3200	SpaceWise DT	120-277	24	138	80	4000	PAV1FT8Y	4/84	70,000	CA, TN, PA
<b>EvoKit Click 2' x 4'</b>															
523704	929001778513	781087162125	2x4 42L 30W 835 UNV 0-10 P4	DLC Premium	4200	0-10V	120-277	30	139	80	3500	P1W5T132	4/60	70,000	CA, TN, PA
523720	929001778713	781087162149	2x4 42L 30W 840 UNV 0-10 P4	DLC Premium	4200	0-10V	120-277	30	144	80	4000	PD7HU98K	4/60	70,000	CA, TN, PA
523498	929001776613	781087161937	2x4 42L 29W 835 UNV SWZ P1	DLC Premium	4200	SpaceWise DT	120-277	29	139	80	3500	PLMZAJXS	1/33	70,000	CA, TN, PA
523886	929001780313	781087162309	2x4 42L 29W 840 UNV SWZ P4	DLC Premium	4200	SpaceWise DT	120-277	29	144	80	4000	PGHJGPF1	4/60	70,000	CA, TN, PA

\* When searching for DLC or NSF listings, please use the first 10-digits only.

● Stock Ready (returnable)



interact ready.

## LED Tubes

### CorePro InstantFit T5 & T8 (Type A/C)



Most lamps are DLC listed  
and all are NSF listed

### Why choose CorePro InstantFit T5 & T8 LED Tubes?

- Works with more ballasts and drivers than any other lamp so it's going to perform as expected and prevent rework
- Proven over 40% energy savings<sup>1</sup> over fluorescent for continual payback over the life of the product
- Average life rating of 50,000 hours<sup>2</sup>
- No mercury allowing for non-hazardous waste disposal



#### CorePro InstantFit T5 (Type A/C) LED tubes

Cat. No.	Model Number*	UPC Code	Product Description	C/P Qty	Dist. Center
<b>CorePro InstantFit (Type A) BAA</b>					
576777	929003144504	046677576776	10.5T8/COR/48-835/IF15/G/DIM/BAA 25/1	25/2100	-
576785	929003144604	046677576783	10.5T8/COR/48-840/IF16/G/DIM/BAA 25/1	25/2100	-
576793	929003144704	046677576790	10.5T8/COR/48-850/IF16/G/DIM/BAA 25/1	25/2100	-
576801	929003144804	046677576806	14T8/COR/48-835/IF21/G/DIM/BAA 25/1	25/2100	-
576819	929003144904	046677576813	14T8/COR/48-840/IF22/G/DIM/BAA 25/1	25/2100	-
576827	929003145004	046677576820	14T8/COR/48-850/IF22/G/DIM/BAA 25/1	25/2100	-
<b>CorePro InstantFit - T5 2ft</b>					
476416	929001823104	046677476410	8T5HE/22-830/IF10/G/DIM 10/1	10/1560	TN
476424	929001823204	046677476427	8T5HE/22-835/IF10/G/DIM 10/1	10/1560	PA, TN
476432	929001823304	046677476434	8T5HE/22-840/IF10/G/DIM 10/1	10/1560	CA, TN, PA
476440	929001823404	046677476441	8T5HE/22-850/IF10/G/DIM 10/1	10/1560	TN
<b>CorePro InstantFit - T5 3ft</b>					
476457	929001823504	046677476458	11T5HE/34-830/IF14/G/DIM 10/1	10/910	TN
476465	929001823604	046677476465	11T5HE/34-835/IF14/G/DIM 10/1	10/910	PA, TN
476473	929001823704	046677476472	11T5HE/34-840/IF15/G/DIM 10/1	10/910	CA, TN, PA
476481	929001823804	046677476489	11T5HE/34-850/IF15/G/DIM 10/1	10/910	TN
<b>CorePro InstantFit - T5 4ft</b>					
476499	929001823904	046677476496	14T5HE/46-830/IF20/G/DIM 10/1	10/780	TN
476507	929001824004	046677476502	14T5HE/46-835/IF20/G/DIM 10/1	10/780	CA, TN, PA
476515	929001824104	046677476519	14T5HE/46-840/IF21/G/DIM 10/1	10/780	CA, TN, PA
476523	929001824204	046677476526	14T5HE/46-850/IF21/G/DIM 10/1	10/780	PA, TN

#### CorePro InstantFit T8 (Type A) LED tubes

Cat. No.	Model Number*	UPC Code	Product Description	C/P Qty	Dist. Center
<b>CorePro InstantFit - T8 4ft</b>					
553214	929002252734	046677553210	10T8/COR/48-830/IF15/G/DIM 10/1	10/600	TN
553222	929002252834	046677553227	10T8/COR/48-835/IF15/G/DIM 10/1	10/600	CA, TN, PA
553230	929001991734	046677553234	10T8/COR/48-840/IF16/G/DIM 10/1	10/600	CA, TN, PA
553248	929001991834	046677553241	10T8/COR/48-850/IF16/G/DIM 10/1	10/600	CA, TN, PA
470096	929001343034	046677452407	14T8/COR/48-830/IF20/G/DIM 10/1	10/650	TN
470104	929001343134	046677452759	14T8/COR/48-835/IF20/G/DIM 10/1	10/650	CA, TN, PA
470112	929001343234	046677453251	14T8/COR/48-840/IF21/G/DIM 10/1	10/650	CA, TN, PA
470120	929001343334	046677452483	14T8/COR/48-850/IF21/G/DIM 10/1	10/650	CA, TN, PA
542084	929001960604	046677542085	16T8/LED/48-840/IF18/G 25/1	25/900	CA, TN, PA
542092	929001960704	046677542092	16T8/LED/48-850/IF18/G 25/1	25/900	CA, TN, PA
<b>CorePro InstantFit - T8 8ft</b>					
533000	929001897104	046677533007	30T8/PRO/96-830/IF39/G/FA8 10/1	10/400	TN
533018	929001897204	046677533014	30T8/PRO/96-835/IF39/G/FA8 10/1	10/400	TN
533026	929001897304	046677533021	30T8/PRO/96-840/IF42/G/FA8 10/1	10/400	CA, TN, PA
533034	929001897404	046677533038	30T8/PRO/96-850/IF42/G/FA8 10/1	10/400	CA, TN, PA

1. Savings based on comparison to F28T5 electronic instant start systems.
  2. Tested to B50 L70 requirement. LED lifetime means the length of time (in hours) until half of the LED light sources maintain at least 70% of their initial lumen output (B50, L70).
- \* When searching for DLC or NSF listings, please use the first 10-digits only.





Shatter-resistant lamps prevent breakage



### Why choose MasterClass InstantFit T5 & T8 LED Tubes?

- Works with more ballasts and drivers than any other lamp so it's going to perform as expected and prevent rework
- Proven over 40% energy savings<sup>1</sup> over fluorescent for continual payback over the life of the product
- Average life rating up to 70,000 hours<sup>2</sup>
- Lamps can be used as either Type A or Type C lamps<sup>3</sup>

#### MasterClass InstantFit T5 & T8 (Type A/C) LED tubes

Cat. No.	Model No.*	UPC Code	Product Description	C/P Qty	Dist. Center
<b>MasterClass (Plastic) InstantFit (Type A/C) - T5 4ft</b>					
● 467126	929001283704	046677467128	24T5HO/46-830/IF33/P/DIM 10/1	10/2000	TN
● 467134	929001283804	046677467135	24T5HO/46-835/IF33/P/DIM 10/1	10/2000	CA, TN, PA
● 467142	929001283904	046677467142	24T5HO/46-840/IF35/P/DIM 10/1	10/2000	CA, TN, PA
● 467159	929001284004	046677467159	24T5HO/46-850/IF35/P/DIM 10/1	10/2000	CA, TN, PA
<b>MasterClass (Plastic) InstantFit (Type A/C) - T8 2ft</b>					
● 541813	929001986904	046677541811	7T8/MAS/24-830/IF10/P/DIM 10/1	10/2380	TN
● 541821	929001987004	046677541828	7T8/MAS/24-835/IF10/P/DIM 10/1	10/2380	CA, TN, PA
● 541839	929001987104	046677541835	7T8/MAS/24-840/IF11/P/DIM 10/1	10/2380	CA, TN, PA
● 541847	929001987204	046677541842	7T8/MAS/24-850/IF11/P/DIM 10/1	10/2380	CA, TN, PA
<b>MasterClass (Plastic) InstantFit (Type A/C) - T8 3ft</b>					
● 539858	929001967504	046677539856	8.5T8/MAS/36-830/IF13/P/DIM 10/1	10/1530	PA, TN
● 539866	929001967904	046677539863	8.5T8/MAS/36-835/IF13/P/DIM 10/1	10/1530	CA, TN, PA
● 539874	929001967604	046677539870	8.5T8/MAS/36-840/IF14/P/DIM 10/1	10/1530	CA, TN, PA
● 539882	929001967704	046677539887	8.5T8/MAS/36-850/IF14/P/DIM 10/1	10/1530	TN

1. Savings based on comparison to F28T5 electronic instant start systems.  
 2. Tested to B50 L70 requirement. LED lifetime means the length of time (in hours) until half of the LED light sources maintain at least 70% of their initial lumen output (B50, L70).  
 3. Type A when paired with a ballast. Type C when paired with a TLED driver.  
 \* When searching for DLC or NSF listings, please use the first 10-digits only.

● Stock Ready (returnable)

Cat. No.	Model No.*	UPC Code	Product Description	C/P Qty	Dist. Center
<b>MasterClass (Plastic) InstantFit (Type A/C) - T8 4ft</b>					
● 565580	929003025304	046677565589	8.9T8/MAS/48-830/IF15/P/DIM 10/1	10/1190	CA, TN, PA
● 565598	929003025404	046677565596	8.9T8/MAS/48-835/IF15/P/DIM 10/1	10/1190	CA, TN, PA
● 565606	929003025504	046677565602	8.9T8/MAS/48-840/IF16/P/DIM 10/1	10/1190	CA, TN, PA
● 565614	929003025604	046677565619	8.9T8/MAS/48-850/IF16/P/DIM 10/1	10/1190	CA, TN, PA
● 473926	929001397634	046677473921	13T8/MAS/48-830/IF20/P/DIM 10/1	10/1190	CA, TN, PA
● 473934	929001397734	046677473938	13T8/MAS/48-835/IF20/P/DIM 10/1	10/1190	CA, TN, PA
● 473942	929001397834	046677473945	13T8/MAS/48-840/IF21/P/DIM 10/1	10/1190	CA, TN, PA
● 473958	929001397934	046677473952	13T8/MAS/48-850/IF21/P/DIM 10/1	10/1190	CA, TN, PA
● 533372	929002016304	046677545185	15.5T8/MAS/48-835/IF24/P/DIM 25/1	25/1400	CA, TN, PA
● 545194	929002016404	046677545192	15.5T8/MAS/48-840/IF25/P/DIM 25/1	25/1400	CA, TN, PA
● 545200	929002016504	046677545208	15.5T8/MAS/48-850/IF25/P/DIM 25/1	25/1400	CA, TN, PA
<b>MasterClass (Plastic) InstantFit (Type A/C) - T8 6ft</b>					
● 541854	929001987404	046677541859	13T8-6U/MAS/24-830/IF20/P/DIM 10/1	10/400	TN
● 541862	929001987504	046677541866	13T8-6U/MAS/24-835/IF20/P/DIM 10/1	10/400	CA, TN, PA
● 541870	929001987604	046677541873	13T8-6U/MAS/24-840/IF21/P/DIM 10/1	10/400	CA, TN, PA
● 541888	929001987704	046677541880	13T8-6U/MAS/24-850/IF21/P/DIM 10/1	10/400	PA, TN
<b>MasterClass (Plastic) InstantFit (Type A/C) - T8 8ft</b>					
● 469247	929001307804	046677472573	35T8/96-3500 IF FA8 10/1	10/300	PA, TN
● 469254	929001314604	046677472580	35T8/96-4000 IF FA8 10/1	10/300	CA, TN, PA





**Patented design**  
prevents shock with  
surge protection

### Why choose CorePro MainsFit T5 & T8 LED Tubes?

- Double-ended for faster installs
- Proven over 40% energy savings<sup>1</sup> over fluorescent systems
- Average life rating of 50,000 hours<sup>2</sup>
- UL Type B ballast bypass
- Emergency capable with Philips PTB15D, Bodine ELI-S-20 or ELI-S-100 EM drivers



### CorePro MainsFit T5 & T8 (Type B) LED tubes

Cat. No.	Model No.*	UPC Code	Product Description	C/P Qty	Dist. Center
<b>CorePro MainsFit (Type B) – T5 2ft</b>					
576140	929003122704	046677576141	8T5HE/COR/22-835/MF10/G 25/1	25/2100	-
576157	929003122804	046677576158	8T5HE/COR/22-840/MF10/G 25/1	25/2100	-
<b>CorePro MainsFit (Type B) – T5 3ft</b>					
576173	929003123004	046677576172	10T5HE/COR/34-835/MF13/G 25/1	25/1200	-
576181	929003123104	046677576189	10T5HE/COR/34-840/MF14/G 25/1	25/1200	-
576199	929003123204	046677576196	10T5HE/COR/34-850/MF14/G 25/1	25/1200	-
<b>CorePro MainsFit (Type B) – T5 4ft</b>					
576207	929003123304	046677576202	14T5HE/COR/46-835/MF20/G 25/1	25/1050	-
576215	929003123404	046677576219	14T5HE/COR/46-840/MF21/G 25/1	25/1050	-
576223	929003123504	046677576226	14T5HE/COR/46-850/MF21/G 25/1	25/1050	-
542050	929001992504	046677542054	25T5HO/COR/46-835/MF33/G 25/1	25/1200	TN
542068	929001992604	046677542061	25T5HO/COR/46-840/MF35/G 25/1	25/1200	CA, TN, PA
542076	929001992704	046677542078	25T5HO/COR/46-850/MF35/G 25/1	25/1200	CA, TN, PA

Cat. No.	Model No.*	UPC Code	Product Description	C/P Qty	Dist. Center
<b>CorePro MainsFit (Type B) – T8 BAA</b>					
563692	929002497304	046677563691	11T8/COR/48-835/MF16/G/BAA 25/1	25/2100	TN
563700	929002497404	046677563707	11T8/COR/48-840/MF16/G/BAA 25/1	25/2100	TN
563718	929002497504	046677563714	11T8/COR/48-850/MF16/G/BAA 25/1	25/2100	TN
563726	929002497604	046677563721	15.5T8/COR/48-835/MF21/G/BAA 25/1	25/2100	TN
563734	929002497704	046677563738	15.5T8/COR/48-840/MF21/G/BAA 25/1	25/2100	TN
563742	929002497804	046677563745	15.5T8/COR/48-850/MF21/G/BAA 25/1	25/2100	TN
563759	929002497904	046677563752	8.5T8/COR/24-835/MF11/G/BAA 25/1	25/4900	TN
563767	929002498004	046677563769	8.5T8/COR/24-840/MF11/G/BAA 25/1	25/4900	TN
563775	929002498104	046677563776	8.5T8/COR/24-850/MF11/G/BAA 25/1	25/4900	TN
<b>CorePro MainsFit (Type B) – T8 with Selectable CCT</b>					
576827	929003145004	04667756820	14T8/COR/48-850/IF22/G/DIM/BAA 25/1	25/2100	-
568519	929003051333	046677568511	14T8/LED/48-5CCT/MF18/G/DS 1/10	1/70	TN

1. Savings based on comparison to F32T8 electronic instant start systems.  
 2. Tested to B50 L70 requirement. LED lifetime means the length of time (in hours) until half of the LED light sources maintain at least 70% of their initial lumen output (B50, L70).  
 \* When searching for DLC or NSF listings, please use the first 10-digits only.

• Stock Ready (returnable)





**Patented design**  
prevents shock with  
surge protection



### Why choose CorePro MainsFit T5 & T8 LED Tubes?

- Double-ended for faster installs
- Proven over 40% energy savings<sup>1</sup> over fluorescent systems
- Average life rating of 50,000 hours<sup>2</sup>
- UL Type B ballast bypass
- Emergency capable with Philips PTB15D, Bodine ELI-S-20 or ELI-S-100 EM drivers

#### CorePro MainsFit T8 (Type B) LED tubes

Cat. No.	Model No.*	UPC Code	Product Description	C/P Qty	Dist. Center
<b>CorePro MainsFit (Type B) – T8 2ft</b>					
535450	929001933804	046677535452	8.5T8/COR/24-830/MF11/G 10/1	10/900	TN
535468	929001933904	046677535469	8.5T8/COR/24-835/MF11/G 10/1	10/900	TN
535476	929001934004	046677535476	8.5T8/COR/24-840/MF11/G 10/1	10/900	CA, TN, PA
535484	929001934104	046677535483	8.5T8/COR/24-850/MF11/G 10/1	10/900	TN
<b>CorePro MainsFit (Type B) – T8 3ft</b>					
535492	929001934204	046677535490	11.5T8/COR/36-830/MF13/G 10/1	10/540	TN
535500	929001934304	046677535506	11.5T8/COR/36-835/MF13/G 10/1	10/540	TN
535518	929001934404	046677535513	11.5T8/COR/36-840/MF14/G 10/1	10/540	CA, TN, PA
535526	929001934504	046677535520	11.5T8/COR/36-850/MF14/G 10/1	10/540	TN
<b>CorePro MainsFit (Type B) – T8 4ft</b>					
563452	929002483704	046677563455	9.9T8/COR/48-835/MF15/G 10/1	10/780	CA, TN, PA
563460	929002483804	046677563462	9.9T8/COR/48-840/MF16/G 10/1	10/780	CA, TN, PA
563478	929002483904	046677563479	9.9T8/COR/48-850/MF16/G 10/1	10/780	CA, TN, PA
563494	929002484104	046677563493	12T8/COR/48-835/MF17/G 10/1	10/650	CA, TN, PA
563502	929002484204	046677563509	12T8/COR/48-840/MF18/G 10/1	10/650	CA, TN, PA
563510	929002484304	046677563516	12T8/COR/48-850/MF18/G 10/1	10/650	CA, TN, PA
563536	929002484504	046677563530	14.5T8/COR/48-835/MF20/G 10/1	10/650	CA, TN, PA
563544	929002484604	046677563547	14.5T8/COR/48-840/MF21/G 10/1	10/650	CA, TN, PA
563551	929002484704	046677563554	14.5T8/COR/48-850/MF21/G 10/1	10/650	CA, TN, PA

Cat. No.	Model No.*	UPC Code	Product Description	C/P Qty	Dist. Center
<b>CorePro MainsFit (Type B) – T8 8ft</b>					
575134	929003099404	046677575137	42T8HO/COR/96-840/MF54/G/FA8 10/1	10/500	CA, TN, PA
575142	929003099504	046677575144	42T8HO/COR/96-850/MF54/G/FA8 10/1	10/500	CA, TN, PA
575720	929003112104	046677575724	33T8/COR/96-840/MF44/G/FA8 10/1	10/500	CA, TN, PA
575738	929003112204	046677575731	33T8/COR/96-850/MF44/G/FA8 10/1	10/500	CA, TN, PA
575746	929003112304	046677575748	42T8HO/COR/96-840/MF54/G/R17d 10/1	10/500	CA, TN, PA
575753	929003112404	046677575755	42T8HO/COR/96-850/MF54/G/R17d 10/1	10/500	CA, TN, PA
<b>CorePro MainsFit (Type B) – T8 Ubend</b>					
535534	929001934604	046677535537	15.5T8-6U/COR/24-830/MF20/G 10/1	10/250	TN
535542	929001934704	046677535544	15.5T8-6U/COR/24-835/MF20/G 10/1	10/250	TN
535559	929001934804	046677535551	15.5T8-6U/COR/24-840/MF21/G 10/1	10/250	CA, TN, PA
535567	929001934904	046677535568	15.5T8-6U/COR/24-850/MF21/G 10/1	10/250	TN

1. Savings based on comparison to F32T8 electronic instant start systems.  
 2. Tested to B50 L70 requirement. LED lifetime means the length of time (in hours) until half of the LED light sources maintain at least 70% of their initial lumen output (B50, L70).  
 \* When searching for DLC or NSF listings, please use the first 10-digits only.

• Stock Ready (returnable)



# PHILIPS

## LED Tubes

### MasterClass MainsFit T8 (Type B)



**Patented design**  
prevents shock with  
surge protection

### Why choose MasterClass MainsFit T8 LED Tubes?

- Shatter-resistant lamps prevent breakage, not just contain the shattered glass
- Proven over 40% energy savings<sup>1</sup> over fluorescent systems
- Average life rating up to 70,000 hours<sup>2</sup>
- UL Type B ballast bypass double-ended
- Emergency capable with Philips PTB15D, Bodine ELI-S-20 or ELI-S-100 EM drivers



### MasterClass MainsFit T8 (Type B) LED tubes

Catalog Number	Model Number*	UPC Code	Product Description	Case/Pallet Qty	Distribution Center
<b>MasterClass (Plastic) MainsFit (Type B) - T8 4ft</b>					
557355	929002325104	046677557355	10.5T8/MAS/48-835/MF16/P 10/1	10/900	CA, TN, PA
557363	929002325204	046677557362	10.5T8/MAS/48-840/MF16/P 10/1	10/900	CA, TN, PA
557371	929002325304	046677557379	10.5T8/MAS/48-850/MF16/P 10/1	10/900	CA, TN, PA
557397	929002325504	046677557393	14.5T8/MAS/48-835/MF20/P 10/1	10/900	CA, TN, PA
557405	929002325604	046677557409	14.5T8/MAS/48-840/MF21/P 10/1	10/900	CA, TN, PA
557413	929002325704	046677557416	14.5T8/MAS/48-850/MF21/P 10/1	10/900	CA, TN, PA
557389	929002325404	046677557386	14.5T8/MAS/48-830/MF20/P 10/1	10/900	TN
561712	929002439504	046677561710	16.9T8/MAS/48-840/MF25/P 10/1	10/900	TN
561720	929002442404	046677561727	16.9T8/MAS/48-835/MF25/P 10/1	10/900	TN
575571	929002442534	046677575571	16.9T8/MAS/48-850/MF25/P 10/1	10/900	TN

1. Savings based on comparison to F32T8 electronic instant start systems.
  2. Tested to B50 L70 requirement. LED lifetime means the length of time (in hours) until half of the LED light sources maintain at least 70% of their initial lumen output (B50, L70).
- \* When searching for DLC or NSF listings, please use the first 10-digits only.

● Stock Ready (returnable)



# PHILIPS

## LED Tubes

### CorePro FlexFit T8 (Type A+B)



Color consistency  
throughout life



## Why choose CorePro FlexFit T8 LED Tubes?

- One lamp for two applications, works as either a plug-and-play (UL Type A) or ballast bypass (UL Type B) lamp
- Provide the flexibility to fit your lighting application needs. As a Type A lamp it is compatible with a variety of ballasts, however, if a ballast is not desired the lamp can quickly be installed as a double-ended ballast bypass lamp
- 50,000 hr<sup>1</sup> rated life and standard 5-year limited warranty<sup>2</sup>
- Glass tube with > 320° illumination angle

### CorePro FlexFit T8 (Type A+B) LED tubes

Catalog Number	Model Number*	UPC Code	Product Description	Case/Pallet Qty	Distribution Center
CorePro FlexFit (Type A+B) - T8 4ft					
560193	929002402204	046677560195	12.5T8/COR/48-835/FF18/G 25/1	25/400	TN
600189	929002317304	046677600181	12.5T8/COR/48-840/FF18/G 25/1	25/400	CA, TN, PA
600197	929002317404	046677600198	12.5T8/COR/48-850/FF18/G 25/1	25/400	CA, TN, PA

1. Tested to B50 L70 requirement. LED lifetime means the length of time (in hours) until half of the LED light sources maintain at least 70% of their initial lumen output (B50, L70).

2. See [www.signify.com/warranties](http://www.signify.com/warranties) for details.

\* When searching for DLC or NSF listings, please use the first 10-digits only.

● Stock Ready (returnable)



## LED Tubes

### MasterClass InstantFit T5 (Type A/C)

Quality and performance that you can count on



### Why choose MasterClass InstantFit T5 LED Tubes?

- Offers ultra-efficiency in the widest variety of lamp types to replace fluorescent lamp types for most applications
- Lamps can be used as either a Type A or a Type C solution



### MasterClass InstantFit T5 (Type A/C) LED tubes

Catalog Number	Model Number*	UPC Code	Product Description	Case/Pallet Qty	Distribution Center
MasterClass (Plastic) InstantFit - T5 4ft					
● 467126	929001283704	046677467128	24T5HO/46-830/IF33/P/DIM 10/1	10/2000	TN
● 467134	929001283804	046677467135	24T5HO/46-835/IF33/P/DIM 10/1	10/2000	CA, TN, PA
● 467142	929001283904	046677467142	24T5HO/46-840/IF35/P/DIM 10/1	10/2000	CA, TN, PA
● 467159	929001284004	046677467159	24T5HO/46-850/IF35/P/DIM 10/1	10/2000	CA, TN, PA

\* When searching for DLC or NSF listings, please use the first 10-digits only.



**Simple plug-and-play installation** with no need to change a ballast

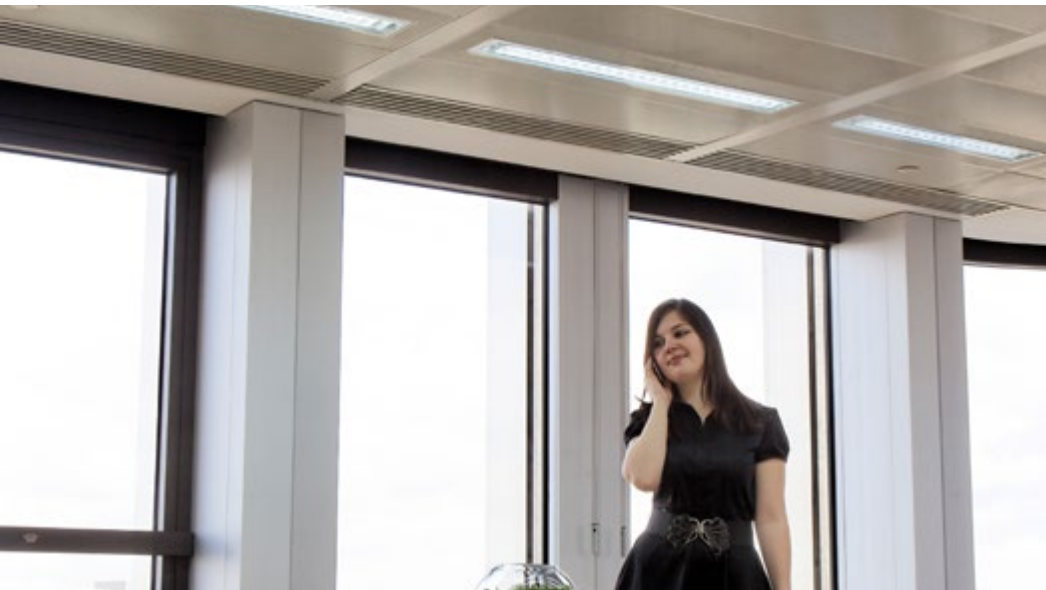

### Why choose UniversalFit T8 LED Tubes?

- UL Type A T8 lamps works on both T12 magnetic and T8 and T12 electronic ballasts
- Energy savings of up to 50%<sup>1</sup>
- Average life rating of 36,000 hours<sup>2</sup>
- Minimal color shift and stable flux output throughout lifetime
- No mercury allowing for non-hazardous waste disposal
- No harmful UV radiation

#### CorePro UniversalFit T8 LED tubes

Catalog Number	Model Number*	UPC Code	Product Description	Case/Pallet Qty	Distribution Center
<b>CorePro UniversalFit – T8 4ft</b>					
539972	929001965904	046677539979	16T8/LED/48-840/UF18/G 10/1	10/650	PA, TN
539980	929001966004	046677539986	16T8/LED/48-850/UF18/G 10/1	10/650	TN

1. Savings based on comparison to F32T8 electronic instant start systems.
  2. Tested to B50 L70 requirement. LED lifetime means the length of time (in hours) until half of the LED light sources maintain at least 70% of their initial lumen output (B50, L70).
- \* When searching for DLC or NSF listings, please use the first 10-digits only.



Instant-on and simple lamp-for-lamp replacement solutions

## Why choose CorePro PLED Lamps?

- Most lamps are shatter-resistant and prevent breakage
- Energy savings of up to 60%<sup>1</sup>
- Average life rating of 50,000 hours<sup>2</sup>
- Minimal color shift and stable flux output throughout lifetime
- No mercury allowing for non-hazardous waste disposal
- No harmful UV radiation



## CorePro PLED lamps

Cat. No.	Model No.*	UPC Code	Product Description	C/P Qty	Dist. Center
<b>CorePro 2-pin PL-S - Type A (ballast compatible)</b>					
529511	929001862804	046677529512	5PL-S/LED/13H/827/IF5/P/2P 20/1	20/7920	TN
529560	929001862904	046677529567	5PL-S/LED/13H/830/IF5/P/2P 20/1	20/7920	TN
529578	929001863004	046677529574	5PL-S/LED/13H/835/IF5/P/2P 20/1	20/7920	CA, TN, PA
529586	929001863104	046677529581	5PL-S/LED/13H/840/IF5/P/2P 20/1	20/7920	CA, TN, PA
<b>CorePro 4-pin PL-L - Type B (ballast bypass)</b>					
575100	929003097504	046677575106	17PL-L/COR/22-830/MF22/G/4P 10/1	10/1440	CA, TN, PA
575118	929003097604	046677575113	17PL-L/COR/22-835/MF22/G/4P 10/1	10/1440	CA, TN, PA
575126	929003097704	046677575120	17PL-L/COR/22-840/MF22/G/4P 10/1	10/1440	CA, TN, PA
<b>CorePro 2-pin PL-C - Type A (ballast compatible)</b>					
532333	929001884704	046677532338	5PL-C/LED/13H/835/IF5/P/2P 20/1	20/4760	TN
532374	929001885104	046677532376	5PL-C/LED/13W/835/IF5/P/2P 20/1	20/3600	TN
532341	929001884804	046677532345	5PL-C/LED/13H/840/IF5/P/2P 20/1	20/4760	TN
532382	929001885204	046677532383	5PL-C/LED/13W/840/IF5/P/2P 20/1	20/3600	TN
<b>CorePro 4-pin PL-C - Type A (ballast compatible)</b>					
532432	929001885704	046677532437	5.5PL-C/LED/13W/827/IF5.5/P/4P 20/1	20/3600	TN
532408	929001885404	046677532406	5.5PL-C/LED/13H/830/IF5.5/P/4P 20/1	20/4760	TN
532416	929001885504	046677532413	5.5PL-C/LED/13H/835/IF5.5/P/4P 20/1	20/4760	TN
532457	929001885904	046677532451	5.5PL-C/LED/13W/835/IF5.5/P/4P 20/1	20/3600	TN
532424	929001885604	046677532420	5.5PL-C/LED/13H/840/IF5.5/P/4P 20/1	20/4760	PA
532465	929001886004	046677532468	5.5PL-C/LED/13W/840/IF5.5/P/4P 20/1	20/3600	TN

Cat. No.	Model No.*	UPC Code	Product Description	C/P Qty	Dist. Center
<b>CorePro 4-pin PL-C/T - Type A (ballast compatible)</b>					
458364	929001388004	046677458362	8.5PL-C/T LED/26H-2700 IF 4P 10/1	10/4140	TN
458372	929001388104	046677458379	8.5PL-C/T LED/26H-3000 IF 4P 10/1	10/4140	CA, TN, PA
458380	929001388204	046677458386	8.5PL-C/T LED/26H-3500 IF 4P 10/1	10/4140	CA, TN, PA
458398	929001388304	046677458393	8.5PL-C/T LED/26H-4000 IF 4P 10/1	10/4140	CA, TN, PA
458406	929001388404	046677458409	10.5PL-C/T LED/26V-2700 IF 4P 10/1	10/2960	TN
458414	929001388504	046677458416	10.5PL-C/T LED/26V-3000 IF 4P 10/1	10/2960	CA, TN, PA
458422	929001388604	046677458423	10.5PL-C/T LED/26V-3500 IF 4P 10/1	10/2960	CA, TN, PA
458430	929001388704	046677458430	10.5PL-C/T LED/26V-4000 IF 4P 10/1	10/2960	CA, TN, PA
476069	929001819704	046677476069	12PLC/T LED/32H/827/IF/4P/DIM 1PK 10/1	10/4140	TN
476101	929001820104	046677476106	12PLC/T LED/32V/827/IF/4P/DIM 1PK 10/1	10/4140	TN
476077	929001819804	046677476076	12PLC/T LED/32H/830/IF/4P/DIM 1PK 10/1	10/4140	TN
476119	929001820204	046677476113	12PLC/T LED/32V/830/IF/4P/DIM 1PK 10/1	10/4140	TN
476127	929001820304	046677476120	12PLC/T LED/32V/835/IF/4P/DIM 1PK 10/1	10/4140	PA, TN
476085	929001819904	046677476083	12PLC/T LED/32H/835/IF/4P/DIM 1PK 10/1	10/4140	CA, TN, PA
476093	929001820004	046677476090	12PLC/T LED/32H/840/IF/4P/DIM 1PK 10/1	10/4140	CA, TN, PA
476135	929001820404	046677476137	12PLC/T LED/32V/840/IF/4P/DIM 1PK 10/1	10/4140	CA, TN, PA

1. Savings based on comparison to F32T8 electronic instant start systems.
  2. Tested to B50 L70 requirement. LED lifetime means the length of time (in hours) until half of the LED light sources maintain at least 70% of their initial lumen output (B50, L70).
- \* When searching for DLC or NSF listings, please use the first 10-digits only.





Easy to replace/retrofit  
in most current halogen  
fixtures



### Why choose MasterClass ExpertColor PAR LED Lamps?

- Consistent color and lumen maintenance over life of product
- Deep dimming below 5%
- Up to 90% energy savings compared to halogen lamps<sup>2</sup>
- Average life rating of up to 40,000 hrs<sup>1</sup>
- Up to 5-year limited warranty<sup>3</sup>
- No mercury allowing for non-hazardous waste disposal
- Emit virtually no UV/IR light in the beam

#### MasterClass ExpertColor PAR LED lamps

Cat. No.	Model No.*	UPC Code	Product Description	C/P Qty	Dist. Center
<b>MasterClass ExpertColor - PAR20</b>					
● 535260	929001921804	046677535261	8.5PAR20/PER/927/F25/DIM/EC/120V 6/1FB	6/2244	TN
● 535278	929001921904	046677535278	8.5PAR20/PER/930/F25/DIM/EC/120V 6/1FB	6/2244	TN
● 535300	929001922204	046677535308	8.5PAR20/PER/930/F40/DIM/EC/120V 6/1FB	6/2244	TN
<b>MasterClass ExpertColor - PAR30L</b>					
● 470954	929001340904	046677470951	12PAR30L/EC/F25/927/DIM/120V 6/1	6/768	TN
● 470962	929001341004	046677470968	12PAR30L/EC/F40/927/DIM/120V 6/1	6/768	TN
● 471037	929001285604	046677471033	12PAR30L/EC RETAIL/S10/930/DIM 6/1	6/768	TN
● 471045	929001285704	046677471040	12PAR30L/EC RETAIL/F25/930/DIM 6/1	6/768	PA
● 471052	929001285804	046677471057	12PAR30L/EC RETAIL/F40/930/DIM 6/1	6/768	TN
● 470970	929001341104	046677470975	12PAR30L/EC/F25/940/DIM/120V 6/1	6/768	PA
● 470988	929001341204	046677470982	12PAR30L/EC/F40/940/DIM/120V 6/1	6/768	TN
<b>MasterClass ExpertColor - PAR30S</b>					
● 470906	929001340304	046677470906	12PAR30S/EC/F25/927/DIM/120V 6/1	6/960	PA, TN
● 470922	929001340604	046677470920	12PAR30S/EC/F25/927/DIM/120V B 6/1	6/960	TN
● 470914	929001340404	046677470913	12PAR30S/EC/F40/927/DIM/120V 6/1	6/960	CA, TN, PA
● 470948	929001340804	046677470944	12PAR30S/EC/F40/940/DIM/120V	6/960	PA
● 471060	929001285904	046677471064	12PAR30S/EC RETAIL/S10/930/DIM 6/1	6/960	TN
● 471078	929001286004	046677471071	12PAR30S/EC RETAIL/F25/930/DIM 6/1	6/960	CA, TN, PA
● 471086	929001286104	046677471088	12PAR30S/EC RETAIL/F40/930/DIM 6/1	6/960	CA, TN, PA
● 470930	929001340704	046677470937	12PAR30S/EC/F25/940/DIM/120V	6/960	TN

● Stock Ready (returnable)

Cat. No.	Model No.*	UPC Code	Product Description	C/P Qty	Dist. Center
<b>MasterClass ExpertColor - PAR38</b>					
● 470823	929001339404	046677470821	17PAR38/EC/S8/927/DIM/120V 10/1	6/420	TN
● 470831	929001339504	046677470838	17PAR38/EC/F25/927/DIM/120V 6/1	6/420	CA, TN, PA
● 470864	929001339804	046677470869	17PAR38/EC/F25/927/DIM/120V B 6/1	6/420	TN
● 470849	929001339604	046677470845	17PAR38/EC/F40/927/DIM/120V 6/1	6/420	TN
● 470996	929001285204	046677470999	17PAR38/EC RETAIL/S8/930/DIM 6/1	6/420	PA, TN
● 471003	929001285304	046677471002	17PAR38/EC RETAIL/F25/930/DIM 6/1	6/420	CA, TN, PA
● 471029	929001285504	046677471026	17PAR38/EC RETAIL/F25/930/DIM 6/1	6/420	CA
● 471011	929001285404	046677471019	17PAR38/EC RETAIL/F40/930/DIM 6/1	6/420	TN
● 471797	929001369804	046677471798	17PAR38/EXPERTCOLOR/S8/940/DIM/120V 6/1	6/420	TN
● 470872	929001340004	046677470876	17PAR38/EC/F25/940/DIM/120V 6/1	6/420	TN
● 470880	929001340104	046677470883	17PAR38/EC/F40/940/DIM/120V 6/1	6/420	CA, TN, PA

1. Tested to B50 L70 requirement. LED lifetime means the length of time (in hours) until half of the LED light sources maintain at least 70% of their initial lumen output (B50, L70).
2. A 17W PAR38 LED lamp uses up to 88% less energy than traditional halogen lamps.
3. See [www.signify.com/warranties](http://www.signify.com/warranties) for details.

\* When searching for DLC or NSF listings, please use the first 10-digits only.



**Type B** – Ballast bypass lamps

## Why choose MasterClass TrueForce PAR LED Lamps?

- Unique single-optic lens design for accent lighting reduces glare to improve shopper experience
- High lumen LED PAR lamps that are the perfect transition from CDM lamps
- 25,000-hour rated average life for ENERGY STAR® qualified lamps<sup>1</sup>
- 3-year limited warranty<sup>2</sup>
- No mercury allowing for non-hazardous waste disposal
- Emit virtually no UV/IR light in the beam



## MasterClass TrueForce PAR LED lamps

Catalog Number	Model Number*	UPC Code	Product Description	Case/Pallet Qty	Distribution Center
<b>MasterClass TrueForce – PAR30L</b>					
● 534644	929001917004	046677534646	25.5PAR30L/PER/830/S15/ND/120-277V 6/1FB	6/768	TN
● 534651	929001917104	046677534653	25.5PAR30L/PER/830/F25/ND/120-277V 6/1FB	6/768	TN
● 534669	929001917204	046677534660	25.5PAR30L/PER/930/S15/ND/120-277V 6/1FB	6/768	TN
● 534677	929001917304	046677534677	25.5PAR30L/PER/930/F25/ND/120-277V 6/1FB	6/768	TN
<b>MasterClass TrueForce – PAR30S</b>					
● 534685	929001917404	046677534684	23PAR30S/PER/930/S15/ND/120V 6/1FB	6/960	TN
● 534693	929001917504	046677534691	23PAR30S/PER/930/F25/ND/120V 6/1FB	6/960	TN
<b>MasterClass TrueForce – PAR38</b>					
● 534602	929001916804	046677534608	33PAR38/PER/830/S15/DIM/120V 6/1FB	6/420	TN
● 534628	929001919604	046677534622	33PAR38/PER/830/S15/DIM/120V B 6/1FB	6/420	TN
● 534610	929001916904	046677534615	33PAR38/PER/830/F25/DIM/120V 6/1FB	6/420	CA, TN, PA
● 534594	929001916704	046677534592	36PAR38/PER/830/F25/ND/120V 6/1FB	6/420	TN
● 569723	929003063504	046677569723	27PAR38TrueF 830 F15 DIM 120V-277V 6/1FB	6/120	PA
● 569731	929003063604	046677569730	27PAR38TrueF 830 F25 DIM 120V-277V 6/1FB	6/120	PA

1. Tested to B50 L70 requirement. LED lifetime means the length of time (in hours) until half of the LED light sources maintain at least 70% of their initial lumen output (B50, L70).  
 2. See [www.signify.com/warranties](http://www.signify.com/warranties) for details.

\* When searching for DLC or NSF listings, please use the first 10-digits only.



**Single optic lens** reduces glare to help improve shopping experience



### Why choose CorePro PAR LED Lamps?

- Average life rating of 25,000 hours<sup>1</sup>
- Easy to replace/retrofit in most current halogen fixtures
- 3-year limited warranty<sup>2</sup>
- Complies with Title 20 regulations
- No mercury allowing for non-hazardous waste disposal
- Emit virtually no UV/IR light in the beam

#### CorePro PAR lamps

Catalog Number	Model Number*	UPC Code	Product Description	Case/Pallet Qty	Distribution Center
<b>CorePro Plastic – PAR30L dimmable</b>					
● 546969	929002045404	046677546960	9.4PAR30L/COR/930/F25/DIM/120V T20 6/1FB	6/768	CA
● 546977	929002045504	046677546977	9.4PAR30L/COR/930/F40/DIM/120V T20 6/1FB	6/768	CA, TN
<b>CorePro Plastic – PAR30S dimmable</b>					
● 546985	929002045604	046677546984	9.4PAR30S/COR/930/F25/DIM/120V T20 6/1FB	6/1320	CA
● 546993	929002045704	046677546991	9.4PAR30S/COR/930/F40/DIM/120V T20 6/1FB	6/1320	CA, TN
<b>CorePro Plastic – PAR38 dimmable</b>					
● 551887	929002238204	046677551889	10PAR38/COR/930/F25/DIM/120V T20 6/1FB	6/384	TN
● 551895	929002238304	046677551896	10PAR38/COR/930/F40/DIM/120V T20 6/1FB	6/384	TN
● 546929	929002045004	046677546922	14PAR38/COR/927/F25/DIM/120V T20 6/1FB	6/384	TN
● 546937	929002045104	046677546939	14PAR38/COR/927/F40/DIM/120V T20 6/1FB	6/384	CA
● 546945	929002045204	046677546946	14PAR38/COR/930/F25/DIM/120V T20 6/1FB	6/384	CA
● 576470	929003133804	046677576479	14PAR38/COR/930/F25/D/P/B/ULW/T20 6/1FB	6/384	TN
● 546950	929002045304	046677546953	14PAR38/COR/930/F40/DIM/120V T20 6/1FB	6/384	CA
● 555300	929001892723	046677555306	15.5PAR38/LED/950/F50/ND/grow/T20 4/1CT	4/468	TN

1. Tested to B50 L70 requirement. LED lifetime means the length of time (in hours) until half of the LED light sources maintain at least 70% of their initial lumen output (B50, L70).  
 2. See [www.signify.com/warranties](http://www.signify.com/warranties) for details.

\* When searching for DLC or NSF listings, please use the first 10-digits only.



Single optic reduces glare to help improve shopping experience

### Why choose CorePro PAR LED Lamps?

- 25,000-hour rated average life for ENERGY STAR® qualified lamps<sup>1</sup>
- Glass finish to replicate look and feel of traditional halogen PARs
- Wet location rated
- 3-year limited warranty<sup>2</sup>



### CorePro PAR LED lamps

Cat. No.	Model No.*	UPC Code	Product Description	C/P Qty	Dist. Center
<b>CorePro Glass - PAR20</b>					
568063	929003026104	046677568061	5.5PAR20/LED/F25/930/DIM/G/T20 6/1FB	6/2244	CA, TN, PA
568071	929003026204	046677568078	5.5PAR20/LED/F25/940/DIM/G/T20 6/1FB	6/2244	CA
568113	929003026704	046677568115	5.5PAR20/LED/F40/927-922/DIM/G/T20 6/1FB	6/2244	CA, TN, PA
568089	929003026404	046677568085	5.5PAR20/LED/F40/930/DIM/G/T20 6/1FB	6/2244	CA, TN, PA
568097	929003026504	046677568092	5.5PAR20/LED/F40/940/DIM/G/T20 6/1FB	6/2244	CA, TN
471102	929001317204	046677471101	7PAR20/LED/F25/827-822/E26/GL/DIM 120V	6/2244	CA, TN, PA
471128	929001316704	046677471125	7PAR20/LED/F25/840/E26/GL/DIM 120V	6/2244	TN
<b>CorePro Glass - PAR30L</b>					
529701	929001321504	046677529703	10PAR30L/LED/827/F25/DIM/ULW/120V 6/1FB	6/768	CA, TN, PA
567965	929003027104	046677567965	8.5PAR30L/LED/940/F25/DIM/GULW/T20 6/1FB	6/768	CA, TN, PA
529735	929001322004	046677529734	10PAR30L/LED/827/F40/DIM/ULW/120V 6/1FB	6/768	CA, TN, PA
567999	929003027404	046677567996	8.5PAR30L/LED/940/F40/DIM/GULW/T20 6/1FB	6/768	PA, TN
529719	929001321604	046677529710	10PAR30L/LED/830/F25/DIM/ULW/120V 6/1FB	6/768	TN
567981	929003027304	046677567989	8.5PAR30L/LED/930/F40/DIM/GULW/T20 6/1FB	6/768	CA, TN, PA
<b>CorePro Glass - PAR30S</b>					
529768	929001320404	046677529765	10PAR30S/LED/827/F25/DIM/ULW/120V 6/1FB	6/960	CA, TN, PA
568014	929003027804	046677568016	8.5PAR30S/LED/930/F25/DIM/GULW/T20 6/1FB	6/960	CA, TN, PA
568022	929003027904	046677568023	8.5PAR30S/LED/940/F25/DIM/GULW/T20 6/1FB	6/960	TN
568048	929003028104	046677568047	8.5PAR30S/LED/930/F40/DIM/GULW/T20 6/1FB	6/960	CA, TN, PA
568055	929003028204	046677568054	8.5PAR30S/LED/940/F40/DIM/GULW/T20 6/1FB	6/960	CA, TN, PA
529792	929001320904	046677529796	10PAR30S/LED/827/F40/DIM/ULW/120V 6/1FB	6/960	TN

Cat. No.	Model No.*	UPC Code	Product Description	C/P Qty	Dist. Center
<b>CorePro Glass - PAR38</b>					
529628	929001319404	046677529628	12PAR38/LED/827/F25/DIM/ULW/120V 6/1FB	6/384	CA, TN, PA
567925	929003028704	046677567927	10PAR38/LED/935/F25/DIM/GULW/T20 6/1FB	6/384	CA
567883	929003028904	046677567880	10PAR38/LED/950/F25/DIM/GULW/T20 6/1FB	6/384	CA
567891	929003029004	046677567897	10PAR38/LED/927/F40/DIM/GULW/T20 6/1FB	6/384	CA, TN, PA
567909	929003029104	046677567903	10PAR38/LED/930/F40/DIM/GULW/T20 6/1FB	6/384	CA, TN, PA
567933	929003029204	046677567934	10PAR38/LED/935/F40/DIM/GULW/T20 6/1FB	6/384	CA
529685	929001320204	046677529680	12PAR38/LED/840/F40/DIM/ULW/120V 6/1FB	6/384	PA
529636	929001319504	046677529635	12PAR38/LED/830/F25/DIM/ULW/120V 6/1FB	6/384	CA, TN, PA
529644	929001319704	046677529642	12PAR38/LED/840/F25/DIM/ULW/120V 6/1FB	6/384	TN
567750	929003029504	046677567750	13PAR38/LED/927/F25/DIM/GULW/T20 6/1FB	6/384	CA, TN, PA
567768	929003029604	046677567767	13PAR38/LED/930/F25/DIM/GULW/T20 6/1FB	6/384	CA, TN, PA
567834	929003029704	046677567835	13PAR38/LED/935/F25/DIM/GULW/T20 6/1FB	6/384	CA
567776	929003029804	046677567774	13PAR38/LED/940/F25/DIM/GULW/T20 6/1FB	6/384	CA, TN
567784	929003029904	046677567781	13PAR38/LED/950/F25/DIM/GULW/T20 6/1FB	6/384	CA, TN, PA
567792	929003030004	046677567798	13PAR38/LED/927/F40/DIM/GULW/T20 6/1FB	6/384	CA, TN, PA
567842	929003030204	046677567842	13PAR38/LED/935/F40/DIM/GULW/T20 6/1FB	6/384	CA
567818	929003030304	046677567811	13PAR38/LED/940/F40/DIM/GULW/T20 6/1FB	6/384	CA
567800	929003030104	046677567804	13PAR38/LED/930/F40/DIM/GULW/T20 6/1FB	6/384	CA, TN, PA
529610	929001319204	046677529611	14PAR38/LED/850/F40/DIM/ULW/120V 6/1FB	6/384	CA, TN, PA

1. Tested to B50 L70 requirement. LED lifetime means the length of time (in hours) until half of the LED light sources maintain at least 70% of their initial lumen output (B50, L70).  
 2. See [www.signify.com/warranties](http://www.signify.com/warranties) for details.  
 \* When searching for DLC or NSF listings, please use the first 10-digits only.



Clearly defined beam spread enhancing the appearance of items on display



### Why choose MasterClass MR16 LED Lamps?

- Compatible with most commonly available halogen transformers
- Average life rating of 25,000 hours<sup>1</sup>
- No mercury allowing for non-hazardous waste disposal
- Emit virtually no UV/IR light in the beam
- 3-year limited warranty<sup>2</sup>

### MasterClass MR16 LED lamps

Catalog Number	Model Number*	UPC Code	Product Description	Case/Pallet Qty	Distribution Center
<b>MasterClass Warm Glow – MR16</b>					
574400	929003087104	046677574406	6.5MR16/F25/2700-2200 DIM 12V	10/8160	PA
574418	929003087204	046677574413	6.5MR16/F35/2700-2200 DIM 12V	10/8160	PA
573576	929003080704	046677573577	7.8MR16/PER/927/S10/Dim/EC/12V 10/1FB	10/8160	PA
573584	929003080804	046677573584	7.8MR16/PER/930/S10/Dim/EC/12V 10/1FB	10/8160	CA, TN, PA
<b>MasterClass ExpertColor – MR16</b>					
573600	929003081004	046677573607	7.8MR16/PER/927/F25/Dim/EC/12V 10/1FB	10/8160	CA, TN, PA
573618	929003081104	046677573614	7.8MR16/PER/930/F25/Dim/EC/12V 10/1FB	10/8160	CA, TN, PA
573626	929003081204	046677573621	7.8MR16/PER/940/F25/Dim/EC/12V 10/1FB	10/8160	PA
573634	929003081304	046677573638	7.8MR16/PER/927/F35/Dim/EC/12V 10/1FB	10/8160	PA
573642	929003081404	046677573645	7.8MR16/PER/930/F35/Dim/EC/12V 10/1FB	10/8160	PA
470211	929001873304	046677530617	7.8MR16/PER/940/F35/Dim/EC/12V 10/1FB	10/6840	TN
573592	929003080904	046677573591	7.8MR16/PER/940/S10/Dim/EC/12V 10/1FB	10/8160	TN
470153	929001872704	046677530556	7.8MR16/PER/940/S10/Dim/EC/12V 10/1FB	10/6840	PA

1. Tested to B50 L70 requirement. LED lifetime means the length of time (in hours) until half of the LED light sources maintain at least 70% of their initial lumen output (B50, L70).

2. See [www.signify.com/warranties](http://www.signify.com/warranties) for details.

\* When searching for DLC or NSF listings, please use the first 10-digits only.



Single optic reduces glare to help improve shopping experience

### Why choose Title 20 MR16 LED lamps?

- Average life rating of 25,000 hours<sup>1</sup>
- Easy to replace/retrofit in most current halogen fixtures
- 3-year limited warranty<sup>2</sup>
- Complies with Title 20 regulations
- No mercury allowing for non-hazardous waste disposal
- Emit virtually no UV/IR light in the beam



### Title 20 MR16 LED lamps

Catalog Number	Model Number*	UPC Code	Product Description	Case/Pallet Qty	Distribution Center
CorePro - MR16 dimmable					
479139	929001854304	046677479138	6.5MR16/LED/F25/927/D/EC/12V T20 10/1FB	10/6840	CA, TN, PA
479147	929001854404	046677479145	6.5MR16/LED/F25/930/D/EC/12V T20 10/1FB	10/6840	CA
479162	929001854504	046677479169	6.5MR16/LED/F35/927/D/EC/12V T20 10/1FB	10/6840	CA
573568	929003080604	046677573560	6.3MR16/LED/F35/930/D/EC/12V T20 10/1FB	10/8160	CA

1. Tested to B50 L70 requirement. LED lifetime means the length of time (in hours) until half of the LED light sources maintain at least 70% of their initial lumen output (B50, L70).

2. See [www.signify.com/warranties](http://www.signify.com/warranties) for details.

\* When searching for DLC or NSF listings, please use the first 10-digits only.



Glass housing and single optic lens provides **crisp and uniform beam**



### Why choose CorePro GU10 & MR16 LED Lamps?

- Suitable for use in enclosed fixtures<sup>1</sup>
- "Perfect fit" mechanical design fits most MR16 fixtures
- Average life rating of 25,000 hours<sup>2</sup>
- 3-year limited warranty<sup>3</sup>

### CorePro GU10 & MR16 LED lamps

Catalog Number	Model Number*	UPC Code	Product Description	Case/Pallet Qty	Distribution Center
<b>CorePro Glass – GU10</b>					
471565	929002055304	046677471569	4GU10/LED/927-22/F35/G/WG/T20 10/1	10/80	CA, TN, PA
468140	929002055504	046677468149	4GU10/LED/930/F35/DIM/G/120V T20 10/1	10/80	CA, TN, PA
<b>CorePro Glass – MR16</b>					
573865	929003076204	046677573867	7MR16/LED/827/F25/DIM 12V 10/1FB	10/8160	CA, TN, PA
573881	929003076404	046677573881	7MR16/LED/827/F35/DIM 12V 10/1FB	10/8160	CA, TN, PA
573899	929003076504	046677573898	7MR16/LED/830/F35/DIM 12V 10/1FB	10/8160	CA, TN, PA
573873	929003076304	046677573874	7MR16/LED/830/F25/DIM 12V 10/1FB	10/8160	PA
573907	929003072504	046677573904	8MR16/LED/827/F25/DIM 12V 10/1FB	10/8160	CA, TN, PA
573915	929003072604	046677573911	8MR16/LED/830/F25/DIM 12V 10/1FB	10/8160	CA, TN, PA
573949	929003072804	046677573942	8MR16/LED/830/F35/DIM 12V 10/1FB	10/8160	CA, TN, PA
533521	929001881504	046677533526	8.5MR16/LED/840/F25/DIM 12V 10/1FB	10/8160	PA
573931	929003072704	046677573935	8MR16/LED/827/F35/DIM 12V 10/1FB	10/8160	CA, TN, PA
573955	929003072904	046677573959	8MR16/LED/840/F35/DIM 12V 10/1FB	10/8160	CA, TN

1. See Technical Application Guide for complete details. All lamps include an over temperature protection (OTP) feature that systematically reduces the lamp power and consequently its internal temperature should it be subjected to abnormally high ambient temperature conditions.
  2. Tested to B50 L70 requirement. LED lifetime means the length of time (in hours) until half of the LED light sources maintain at least 70% of their initial lumen output (B50, L70).
  3. See [www.signify.com/warranties](http://www.signify.com/warranties) for details.
- \* When searching for DLC or NSF listings, please use the first 10-digits only.

# PHILIPS

## LED Lamps

### MasterClass AR111

**Best-in-class flux, intensity and beam quality**



### Why choose MasterClass AR111 LED Lamps?

- Saves 80% energy when compared to a 75W halogen AR111<sup>1</sup>
- Excellent compatibility with most traditional halogen transformers
- “Perfect fit” mechanical design fits AR111 fixtures
- Anti-glare optical bridge to increase visual comfort
- Average life rating up to 40,000 hours<sup>2</sup>
- Up to 5-year limited warranty<sup>3</sup>



### MasterClass AR111 LED lamps

Catalog Number	Model Number*	UPC Code	Product Description	Case/Pallet Qty	Distribution Center
MasterClass - AR111					
552448	929002238404	046677552442	12AR111/LED/927/S8/DIM/EC 12V 6/1FB	6/858	TN
552406	929002238504	046677552404	12AR111/LED/930/S8/DIM/EC 12V 6/1FB	6/858	TN
552414	929002239004	046677552411	16AR111/LED/927/F25/DIM/EC 12V FB 6/1	6/858	TN
552422	929002239104	046677552428	16AR111/LED/930/F25/DIM/EC 12V 6/1FB	6/858	TN
552430	929002239304	046677552435	16AR111/LED/927/F40/DIM/EC 12V 6/1FB	6/858	TN
552372	929002239604	046677552374	20AR111/LED/930/F15 DIM 12V 6/1FB	6/858	TN
552380	929002239804	046677552381	20AR111/LED/927/F25 DIM 12V 6/1FB	6/858	TN
552398	929002239904	046677552398	20AR111/LED/930/F25 DIM 12V 6/1FB	6/858	TN

1. Light output comparison based upon the ENERGY STAR® Integral LED Lamp Center Beam Intensity Benchmark tool which can be found at EnergyStar.gov/LEDbulbs.
  2. Tested to B50 L70 requirement. LED lifetime means the length of time (in hours) until half of the LED light sources maintain at least 70% of their initial lumen output (B50, L70).
  3. See [www.signify.com/warranties](http://www.signify.com/warranties) for details.
- \* When searching for DLC or NSF listings, please use the first 10-digits only.





A19 Glass Bulbs

A19 Plastic Bulbs

Glass PAR and A19 lamps are UL wet rated for indoor and outdoor use



### Why choose CorePro Party A19 & PAR LED Lamps?

- Bright colorful lighting that offers a festive touch perfect for special occasions, parties and holidays
- LED A19 lamps are available in up to six colors in durable plastic or a classic glass finish
- Average life rating of 10,000 hours<sup>1</sup>

### CorePro Party A19 & PAR LED lamps

Catalog Number	Model Number*	UPC Code	Product Description	Case/Pallet Qty	Distribution Center
<b>MasterClass Party Lamps - A19</b>					
538256	929001937503	046677538255	4A19/LED/PURPLE/G/E26/ND 6/1BC	6/684	CA, TN, PA
538231	929001937303	046677538231	4A19/LED/BLUE/G/E26/ND 6/1BC	6/684	CA, TN, PA
538249	929001937403	046677538248	4A19/LED/GREEN/G/E26/ND 6/1BC	6/684	CA, TN, PA
538223	929001937203	046677538224	4A19/LED/YELLOW/G/E26/ND 6/1BC	6/684	CA, TN, PA
538215	929001937103	046677538217	4A19/LED/ORANGE/G/E26/ND 6/1BC	6/684	CA, TN, PA
538207	929001937003	046677538200	4A19/LED/RED/G/E26/ND 6/1BC	6/684	CA, TN, PA
463208	929001224003	046677463205	8A19/LED/PURPLE/P/ND 120V 6/1BC	6/684	PA
463240	929001998005	046677463243	8A19/LED/BLUE/P/ND 120V 4/1FB	4/2240	PA
463281	929001997905	046677463281	8A19/LED/GREEN/P/ND 120V 4/1FB	4/2240	PA
463257	929001998105	046677463250	8A19/LED/YELLOW/P/ND 120V 4/1FB	4/2240	PA
463232	929001998203	046677463236	8A19/LED/ORANGE/P/ND 120V 6/1BC	6/684	PA, TN
463273	929001997805	046677463274	8A19/LED/RED/P/ND 120V 4/1FB	4/2240	PA
<b>MasterClass Party Lamps - PAR38</b>					
469072	929001306513	046677469078	13.5PAR38/BLUE/FLOOD/ND ULW 1/4	6/448	TN, PA
469098	929001306713	046677469092	13.5PAR38/GREEN/FLOOD/ND ULW 1/4	6/448	CA, TN, PA
469080	929001306613	046677469085	13.5PAR38/YELLOW/FLOOD/ND ULW 1/4	6/448	TN, PA
469106	929001306813	046677469108	13.5PAR38/RED/FLOOD/ND ULW 1/4	6/448	TN, PA

1. See [www.signify.com/warranties](http://www.signify.com/warranties) for details.

\* When searching for DLC or NSF listings, please use the first 10-digits only.



PAR38 Bulbs

# PHILIPS

## LED Lamps

### MasterClass A-Shape



**Superior light quality**  
with high performance  
dimming

### Why choose MasterClass A-Shape LED Lamps?

- Up to 90% energy savings compared to incandescent lamps<sup>1</sup>
- Average life rating of 15,000 hours<sup>2</sup>
- Suitable for enclosed fixtures<sup>3</sup>
- No mercury allowing for non-hazardous waste disposal
- Title 20 qualified for California applications
- 3-year limited warranty<sup>4</sup>



### MasterClass A-Shape LED lamps

Catalog Number	Model Number*	UPC Code	Product Description	Case/Pallet Qty	Distribution Center
<b>A19 40W lamp equivalent dimming</b>					
● 549485	929001969504	046677549480	5A19/PER/927-922/CL/G/E26/WGX 1FB T20	6/1872	CA, TN, PA
● 479428	929001940704	046677544522	5A19/PER/927-22/P/E26/WG 6/1FB T20	6/2430	CA, TN, PA
<b>A19 60W lamp equivalent dimming</b>					
● 479444	929001940904	046677544539	8.8A19/PER/927-22/P/E26/WG 6/1FB T20	6/2430	CA, TN, PA
● 549493	929001969604	046677549497	8A19/PER/927-922/CL/G/E26/WGX 1FB T20	6/1872	CA, TN, PA
● 557587	929002327703	046677557584	8.5A19/PER/927-22/FR/G/WGD 4/2FB T20	8/2016	CA, TN, PA
<b>A19 75W equivalent lamps dimming</b>					
● 561000	929002285404	046677561000	12.2A19/PER/927-22/P/E26/WG 6/1FB T20	6/2430	CA, TN, PA
● 479469	929001941104	046677479466	12.2A21/PER/927-22/P/E26/WG 6/1FB T20	6/1260	CA, TN, PA
<b>A19 100W equivalent lamps dimming</b>					
● 561027	929002285504	046677561024	16A19/PER/927-22/P/E26/WG 6/1FB T20	6/2430	CA, TN, PA
<b>A19 150W equivalent lamps dimming</b>					
● 558221	929002343003	046677558222	29A21/PER/827-22/P/E26/WG/HO 4/1FB	4/1280	CA, TN, PA
<b>3-way switching lamps</b>					
● 556928	929002285003	046677556921	18A21/LED/927/P/E26/3WAY ND 4/1FB T20	4/1280	CA, TN, PA
● 556936	929002285103	046677556938	18.5A21/LED/927/P/E26/3WAY ND 4/1FB T20	4/1280	CA, TN, PA
<b>Dusk to Dawn lamps</b>					
● 557728	929002333603	046677557720	8.8A19/AMB/927/ND D2D 4/1FB T20	4/2280	CA, TN, PA

1. An 8.5W LED bulb uses up to 86% less energy than traditional incandescent bulbs.
  2. Tested to B50 L70 requirement. LED lifetime means the length of time (in hours) until half of the LED light sources maintain at least 70% of their initial lumen output (B50, L70).
  3. All MasterClass lamps listed on this page with the exception of the A21 150W equivalent lamps dimming (product number 558221) are suitable for enclosed fixtures.
  4. See [www.signify.com/warranties](http://www.signify.com/warranties) for details.
- \* When searching for DLC or NSF listings, please use the first 10-digits only.

● Stock Ready (returnable)





**Uncompromising quality with dependable performance**



### Why choose CorePro A-Shape LED Lamps

- Up to 90% energy savings compared to incandescent lamps<sup>1</sup>
- Average life rating of 15,000 hours<sup>2</sup>
- Selection of lamps suitable for enclosed fixtures
- No mercury allowing for non hazardous waste disposal
- Select lamps Title 20 qualified for California applications
- Expanded dimmable/non-dimmable portfolio

### CorePro A-Shape LED lamps

Cat. No.	Model No.*	UPC Code	Product Description	C/P	Dist. Ctr
<b>A19 40W lamp equivalent dimming</b>					
556795	929001950933	046677556792	4.5A19/VIN/820/E26/CL/GL/DIM 4/FBH T20	4/1764	CA, TN, PA
550400	929002035704	046677550400	5A19/PER/927/P/E26/DIM 6/1FB T20	6/2430	PA, CA
550418	929002035804	046677550417	5A19/PER/930/P/E26/DIM 6/1FB T20	6/2430	PA, TN
547042	929002035904	046677547042	5A19/PER/940/P/E26/DIM 6/1FB T20	6/2430	CA, TN, PA
550426	929002036004	046677550424	5A19/PER/950/P/E26/DIM 6/1FB T20	6/2430	CA, TN, PA
549220	929002207804	046677549220	5A19/PER/950/CL/G/E26/DIM 1FB T20	10/1840	TN
<b>A19 40W lamp equivalent non-dimming</b>					
559229	929002311104	046677559229	5A19/LED/827/FR/P/ND 4/2FB	8/2808	TN
571588	929003019904	046677571580	5A19/LED/927/P/E26/ND 6/1FB T20	6/2430	CA
565093	929003004604	046677565091	5A19/LED/930/FR/P/ND 4/1FB	4/2520	PA
571596	929003020004	046677571597	5A19/LED/930/P/E26/ND 6/1FB T20	6/2430	CA
565100	929003004704	046677565107	5A19/LED/950/FR/P/ND 4/1FB	4/2520	PA
571604	929003020104	046677571603	5A19/LED/950/P/E26/ND/T20 6/1FB	6/2430	CA, TN, PA
<b>A19 60W lamp equivalent dimming</b>					
550434	929002036104	046677550431	8.8A19/PER/927/P/E26/DIM 6/1FB T20	6/2430	CA, TN, PA
550442	929002036204	046677550448	8.8A19/PER/930/P/E26/DIM 6/1FB T20	6/2430	CA, TN, PA
557660	929002327504	046677557669	8.8A19/PER/930/P/GU24/DIM 6/1FB T20	6/2430	TN
545897	929002032304	046677545895	8.8A19/PER/940/P/E26/DIM 6/1FB T20	6/2430	CA, TN, PA
550459	929002036304	046677550455	8.8A19/PER/950/P/E26/DIM 6/1FB T20	6/2430	CA, TN, PA
<b>A19 60W lamp equivalent non-dimming</b>					
571612	929003020204	046677571610	8.8A19/LED/927/P/E26/ND/T20 6/1FB	6/2430	CA, TN, PA
571620	929003020304	046677571627	8.8A19/LED/930/P/E26/ND 6/1FB T20	6/2430	CA
554444	929002227304	046677554446	8.8A19/LED/950/P/E26/ND 6/1FB T20	6/2430	CA, TN, PA
559252	929002311304	046677559250	8.5A19/LED/827/FR/P/ND 4/2FB	4/1404	TN, PA
559351	929002311404	046677559359	8.5A19/LED/850/FR/P/ND 4/2FB	4/1404	PA
565127	929003004904	046677565121	8.5A19/LED/930/FR/P/ND 4/1FB	4/2520	PA
565135	929003005004	046677565138	8.5A19/LED/950/FR/P/ND 4/1FB	4/2520	PA

\* When searching for DLC or NSF listings, please use the first 10-digits only.

• Stock Ready (returnable)



See notes and labels on previous page.

Cat. No.	Model No.*	UPC Code	Product Description	C/P	Dist. Ctr
<b>A19 75W equivalent lamps dimming</b>					
561035	929002385204	046677561031	12.2A19/PER/927/P/E26/DIM 6/1FB T20	6/2430	CA, TN, PA
561043	929002385304	046677561048	12.2A19/PER/930/P/E26/DIM 6/1FB T20	6/2430	CA, TN, PA
561050	929002385404	046677561055	12.2A19/PER/940/P/E26/DIM 6/1FB T20	6/2430	CA, TN, PA
560994	929002285204	046677560997	12.2A19/PER/950/P/E26/DIM 6/1FB T20	6/2430	CA, TN, PA
<b>A19/A21 75W lamp equivalent non-dimming</b>					
565143	929003005104	046677565145	10A19/LED/927/FR/P/ND 4/1FB	4/2520	CA, TN, PA
565150	929003005204	046677565152	10A19/LED/930/FR/P/ND 4/1FB	4/2520	PA
565168	929003005304	046677565169	10A19/LED/950/FR/P/ND 4/1FB	4/2520	CA, TN, PA
571646	929003020504	046677571641	12.2A19/LED/927/P/E26/ND/T20 6/1FB	6/2430	CA, TN, PA
571653	929003020604	046677571658	12.2A19/LED/930/P/E26/ND 6/1FB T20	6/2430	CA
571661	929003020704	046677571665	12.2A19/LED/950/P/E26/ND/T20 6/1FB	6/2430	CA, PA
<b>A19/A21 100W equivalent lamps dimming</b>					
561068	929002385504	046677561062	16A19/PER/927/P/E26/DIM 6/1FB T20	6/2430	CA, TN, PA
561076	929002385604	046677561079	16A19/PER/930/P/E26/DIM 6/1FB T20	6/2430	CA, TN, PA
561456	929002385704	046677561451	16A19/PER/940/P/E26/DIM 6/1FB T20	6/2430	CA, TN, PA
561019	929002285304	046677561017	16A19/PER/950/P/E26/DIM 6/1FB T20	6/2430	CA, TN, PA
<b>A21 100W lamp equivalent non-dimming</b>					
559500	929002311704	046677559502	13.5A19/LED/827/FR/P/ND 4/2FB	4/1512	CA, TN, PA
565184	929003005504	046677565183	13.5A19/LED/930/FR/P/ND 4/1FB	4/2268	PA
559419	929002311804	046677559410	13.5A19/LED/850/FR/P/ND 4/2FB	4/1512	CA, TN, PA
554469	929002227604	046677554460	16.6A21/LED/927/P/E26/ND 6/1FB T20	6/1260	CA, TN, PA
554485	929002227704	046677554484	16.6A21/LED/950/P/E26/ND 6/1FB T20	6/1260	CA, TN, PA
571695	929003021004	046677571696	16.6A19/LED/950/P/E26/ND 6/1FB T20	6/2430	CA, TN, PA
<b>A21 150W equivalent lamps dimming</b>					
557678	929002327604	046677557676	16A21/PER/930/P/GU24/DIM 6/1FB T20	6/1440	TN
558239	929002343103	046677558239	29A21/PER/850/P/E26/DIM/HO 4/1FB	4/1280	CA, TN, PA
<b>Large A lamps - 160W-200W-300W equivalent non-dimming</b>					
479287	929001854715	046677479282	20A30/LED/865/P/E26/ND 4/1FB	4/320	CA, TN, PA
479295	929001854815	046677479299	24A35/LED/865/P/E26E39/ND 4/1FB	4/256	CA, TN, PA
479303	929001854915	046677479305	42A40/LED/865/P/E26E39/ND 4/1FB	4/144	CA, TN, PA

# PHILIPS

LED Lamps

Reflectors



Smooth dimming  
down to 10%

## Why choose Reflector LED Lamps?

- Average life rating of 15,000 hours<sup>1</sup>
- Suitable for enclosed fixtures
- Dimmable reflectors are Title 20 qualified for California applications
- No mercury allowing for non-hazardous waste disposal



### Reflector LED lamps

Cat. No.	Model No.*	UPC Code	Product Description	C/P Qty	Dist. Center
<b>R20 45W equivalent lamps dimming</b>					
456979	929002008904	046677456979	5R20/PER/927-22/P/E26/WG 6/1FB T20	6/2340	CA, TN, PA
553883	929002092204	046677553883	5R20/PER/927/P/E26/DIM 6/1FB T20	6/2340	TN
547406	929002035304	046677547400	5R20/PER/930/P/E26/DIM 6/1FB T20	6/2340	TN
547414	929002035404	046677547417	5R20/PER/940/P/E26/DIM 6/1FB T20	6/2340	TN
548123	929002204063	046677548124	5R20/PER/950/P/E26/DIM 6/1FB T20	6/2340	TN
<b>BR30 65W equivalent lamps dimming</b>					
457044	929001870334	046677457044	7.2BR30/PER/922-27/P/E26/WG 6/1FB T20	4/960	CA, TN, PA
553891	929002092304	046677553890	7.2BR30/PER/927/P/E26/DIM 6/1FB T20	6/960	CA, TN, PA
545905	929002032104	046677545901	7.2BR30/PER/930/P/E26/DIM 6/1FB T20	6/960	CA, TN, PA
545913	929002032204	046677545918	7.2BR30/PER/940/P/E26/DIM 6/1FB T20	6/960	CA
548107	929002204163	046677548100	7.2BR30/PER/950/P/E26/DIM 6/1FB T20	3/120	CA, TN, PA
<b>BR30 lamps non-dimming</b>					
541010	929001947903	046677541019	9 BR30/LED/827/FR/P/ND 6/1FB	6/960	CA, TN, PA
<b>BR30 100W equivalent lamps dimming</b>					
558023	929002351403	046677558024	15BR30/PER/927-22/E26/WG/HO 4/1FB T20	4/864	CA, TN, PA
558031	929002351303	046677558031	15BR30/PER/950/E26/DIM/HO 4/1FB T20	4/864	CA, TN, PA

Cat. No.	Model No.*	UPC Code	Product Description	C/P Qty	Dist. Center
<b>BR40W 65W equivalent lamps dimming</b>					
457010	929002009104	046677457013	8.8BR40/PER/927-22/P/E26/WG 6/1FB T20	6/432	CA, TN, PA
553909	929002092404	046677553906	8.8BR40/PER/927/P/E26/DIM 6/1FB T20	6/432	TN
547422	929002035504	046677547424	8.8BR40/PER/930/P/E26/DIM 6/1FB T20	6/432	TN
547430	929002035604	046677547431	8.8BR40/PER/940/P/E26/DIM 6/1FB T20	6/432	TN
548115	929002204263	046677548117	8.8BR40/PER/950/P/E26/DIM 6/1FB T20	6/432	CA, TN, PA
<b>BR40 150W equivalent lamps dimming</b>					
558049	929002351203	046677558048	20BR40/PER/927-22/E26/WG/HO 4/1FB T20	4/384	CA, TN, PA
558056	929002351503	046677558055	20BR40/PER/950/E26/DIM/HO 4/1FB T20	4/384	CA, TN, PA

1. Tested to B50 L70 requirement. LED lifetime means the length of time (in hours) until half of the LED light sources maintain at least 70% of their initial lumen output (B50, L70).  
\* When searching for DLC or NSF listings, please use the first 10-digits only.

• Stock Ready (returnable)





**Excellent color consistency and high color rendering**



### Why choose Decorative A15 & S14 LED Lamps?

- Up to 80% energy savings compared to standard incandescent lamps
- Average life rating of 15,000 hours<sup>1</sup>
- Certain models dim to a warm glow similar to incandescent lamps
- Wet location rated for indoor and outdoor use
- Selection of candelabra and medium based lamps
- Title 20 qualified for California applications

### Decorative A15 & S14 LED lamps

Catalog Number	Model Number*	UPC Code	Product Description	Case/Pallet Qty	Distribution Center
<b>A15 25W equivalent lamps dimming</b>					
● 556555	929002260203	046677556556	3.3A15/VIN/820/E26/CL/GL/DIM 4/1BC T20	4/2720	CA, TN, PA
<b>A15 40W equivalent lamps dimming</b>					
● 549386	929002208304	046677549381	3.8A15/PER/927-922/CL/G/E26/WGX1FB T20	10/3500	TN
● 549378	929002208104	046677549374	3.8A15/PER/927-922/CL/G/E12/WGX1FB T20	10/3500	TN
● 548305	929002209004	046677548308	5A15/PER/950/CL/G/E26/DIM 1FB T20	10/3500	TN
<b>A15 60W equivalent lamps dimming</b>					
● 549402	929002208604	046677549404	5.5A15/PER/927-922/CL/G/E26/WGX1FB	10/3500	CA, TN, PA
● 549394	929002208404	046677549398	5.5A15/PER/927-922/CL/G/E12/WGX1FB	10/3500	TN
<b>S14 10W equivalent lamps non-dimming</b>					
● 575209	929003082704	046677575205	1S14/VIN/827/CL/G/E26/ND 1CT	10/3500	CA

1. Tested to B50 L70 requirement. LED lifetime means the length of time (in hours) until half of the LED light sources maintain at least 70% of their initial lumen output (B50, L70).

2. See [www.signify.com/warranties](http://www.signify.com/warranties) for details.

\* When searching for DLC or NSF listings, please use the first 10-digits only.

Excellent color consistency and high color rendering



### Why choose Globe LED Lamps?

- Up to 80% energy savings compared to standard incandescent lamps
- Average life rating of 15,000 hours<sup>1</sup>
- Smooth dimming down to 10%
- Certain models dim to a warm glow similar to incandescent lamps
- Wet location rated models can be used inside or outside
- Title 20 qualified for California applications



### Globes G16.5 & G25 LED lamps

Cat. No.	Model No.*	UPC Code	Product Description	C/P Qty	Dist. Center
<b>G16.5 25W equivalent lamps dimming</b>					
● 549253	929002204804	046677549251	2.7G16.5/PER/927-922/CL/G/E26/WGX 1FBT20	10/3500	TN
● 549261	929002204904	046677549268	2.7G16.5/PER/927-922/CL/G/E12/WGX 1FBT20	10/3500	TN
● 556829	929001951333	046677556822	4.5G16.5/VIN/820/E12/CL/GL/DIM FBH T20	4/2720	CA, TN, PA
● 537597	929001951353	046677537593	4.5G16.5/VIN/820/E12/CL/GL/DIM 4/BC T20	4/720	CA, TN, PA
● 543157	929002001403	046677543150	3G16.5/MOD/840/E12/CL/GL/DIM 4/BC	4/720	TN
<b>G16.5 40W equivalent lamps dimming</b>					
● 549279	929002205004	046677549275	3.8G16.5/PER/927-922/CL/G/E26/WGX 1FBT20	10/3500	TN
● 549287	929002205104	046677549282	3.8G16.5/PER/927-922/CL/G/E12/WGX 1FBT20	10/3500	TN
● 549311	929002205404	046677549312	3.8G16.5/PER/927-922/FR/G/E26/WGX 1FBT20	10/3500	TN
● 549295	929002205204	046677549299	5.5G16.5/PER/927-922/CL/G/E26/WGX 1FBT20	10/3500	CA, TN, PA

Cat. No.	Model No.*	UPC Code	Product Description	C/P Qty	Dist. Center
<b>G25 25W equivalent lamps dimming</b>					
● 549352	929002204704	046677549350	2.7G25/PER/927-922/CL/G/E26/WGX1FB T20	10/800	TN
● 549360	929002208004	046677549367	2.7G25/PER/927-922/FR/G/E26/WGX1FB T20	10/800	TN
● 543124	929002000803	046677543129	4G25/MOD/840/E26/CL/GL/DIM 4/1BC	4/380	CA, TN, PA
<b>G25 40W equivalent lamps dimming</b>					
● 549501	929001969704	046677549503	3.8G25/PER/927-922/CL/G/E26/WGX1FB T20	10/800	TN
● 549527	929001969904	046677549527	3.8G25/PER/927-922/FR/G/E26/WGX1FB T20	10/800	TN
● 549188	929002206704	046677549183	3.8G25/PER/950/CL/G/E26/DIM 1FBT20	10/800	TN
● 549204	929002206904	046677549206	3.8G25/PER/950/FR/G/E26/DIM 1FBT20	10/800	TN
● 537589	929001951253	046677537586	4.5G25/VIN/820/E26/CL/GL/DIM 4/1BC T20	4/380	CA, TN, PA
● 556811	929001951233	046677556815	4.5G25/VIN/820/E26/CL/GL/DIM 4/FBH T20	4/1080	CA, TN, PA
<b>G25 60W equivalent lamps dimming</b>					
● 549519	929001969804	046677549510	5.5G25/PER/927-922/CL/G/E26/WGX1FB T20	10/800	CA, TN, PA
● 549535	929001970004	046677549534	5.5G25/PER/927-922/FR/G/E26/WGX1FB T20	10/800	TN
● 549196	929002206804	046677549190	5.5G25/PER/950/CL/G/E26/DIM 1FBT20	10/800	TN
● 549212	929002207004	046677549213	5.5G25/PER/950/FR/G/E26/DIM 1FBT20	10/800	TN

1. Tested to B50 L70 requirement. LED lifetime means the length of time (in hours) until half of the LED light sources maintain at least 70% of their initial lumen output (B50, L70).  
\* When searching for DLC or NSF listings, please use the first 10-digits only.

# PHILIPS

## LED Lamps

### MasterClass Designer



Vintage, modern and clear colors for multiple room aesthetics



### Why choose MasterClass Designer LED Lamps?

- Increased energy savings when compared to standard incandescent lamps
- Average life rating of 15,000 hours<sup>1</sup>
- Smooth dimming down to 10%
- Certain models dim to a warm glow similar to incandescent lamps
- Wet location rated models can be used inside or outside
- Title 20 qualified for California applications

### MasterClass Designer LED lamps

Catalog Number	Model Number*	UPC Code	Product Description	Case/Pallet Qty	Distribution Center
<b>ST19</b>					
● 543140	929002001003	046677543143	4ST19/MOD/840/E26/CL/GL/DIM 4/1BC	4/480	CA, TN, PA
● 556530	929002296003	046677556532	5.5ST19/PER/927-922/CL/G/E26/WGX T20	4/1288	CA, TN, PA
● 556548	929002296103	046677556549	5.5ST19/PER/950/CL/G/E26/DIM 1FB T20	4/1288	CA, TN, PA
● 556803	929001951033	046677556808	5ST19/VIN/820/E26/CL/GL/DIM 4/1FB T20	4/1288	CA, TN, PA
<b>T10</b>					
● 556837	929001951533	046677556839	4.5T10/VIN/820/E26/CL/GL/DIM 4/FBH T20	4/2160	TN, PA
● 543132	929002000903	046677543136	4T10/MOD/840/E26/CL/GL/DIM 4/1BC	4/1032	CA, TN, PA
<b>T20</b>					
● 536284	929001936503	046677536282	7.5T20/VIN/820/CL/G/DIM 2/1CT	2/168	CA, TN, PA
● 536318	929001936803	046677536312	7.5T20/modern/840/CL/G/DIM 2/1CT	2/168	CA, TN, PA
<b>A50</b>					
● 536276	929001936403	046677536275	7.5A50/VIN/820/CL/G/DIM 2/1CT	2/78	CA, TN, PA
● 536300	929001936703	046677536305	7.5A50/modern/840/CL/G/DIM 2/1CT	2/78	CA, TN, PA
<b>G63</b>					
● 536268	929001936303	046677536268	7.5G63/VIN/820/CL/G/DIM 2/1CT	2/48	CA, TN, PA
● 536292	929001936603	046677536299	7.5G63/modern/840/CL/G/DIM 2/1CT	2/48	CA, TN, PA

1. Tested to B50 L70 requirement. LED lifetime means the length of time (in hours) until half of the LED light sources maintain at least 70% of their initial lumen output (B50, L70).  
 \* When searching for DLC or NSF listings, please use the first 10-digits only.

● Stock Ready (returnable)





Increased energy savings compared to standard incandescent lamps

### Why choose Candle LED Lamps?

- Selection of clear and vintage, angled and blunt tip lamps for various aesthetic applications
- Average life rating of 15,000 hours<sup>1</sup>
- Smooth dimming down to 10%
- Certain models dim to a warm glow similar to incandescent lamps
- Excellent color consistency and high color rendering



### Candles B11/BA11 & F15 LED lamps

Cat. No.	Model No.*	UPC Code	Product Description	C/P Qty	Dist. Center
<b>B11/BA11 Candles 25W equivalent lamps dimming</b>					
549329	929002204404	046677549329	2B11/PER/927-922/CL/G/E12/WGX1FB T20	10/4320	TN
549246	929002204304	046677549244	2BA11/PER/927-922/CL/G/E12/WGX 1FB T20	10/4000	TN
<b>B11/BA11 Candles 40W equivalent lamps dimming</b>					
549584	929002047204	046677549589	3.3B11/PER/927-922/CL/G/E26/WGX1FB T20	10/4320	CA, TN, PA
549550	929001969304	046677549558	3.3BA11/PER/927-922/CL/G/E26/WGX 1FB T20	10/4320	PA
549154	929002206004	046677549152	3.3B11/PER/950/CL/G/E26/DIM 1FBT20	10/4320	TN
549139	929002205804	046677549138	3.3BA11/PER/950/CL/G/E26/DIM 1FB T20	10/4320	PA
549568	929001969404	046677549565	3.3B11/PER/927-922/CL/G/E12/WGX 1FB T20	10/4320	CA, TN, PA
549147	929002205904	046677549145	3.3B11/PER/950/CL/G/E12/DIM 1FBT20	10/4320	TN
549121	929002205704	046677549121	3.3BA11/PER/950/CL/G/E12/DIM 1FB T20	10/4000	PA
549543	929001969204	046677549541	3.3BA11/PER/927-922/CL/G/E12/WGX 1FB T20	10/4000	CA, TN, PA
556845	929001951133	046677556846	4.5BA11/VIN/820/E12/CL/GL/DIM 4/FBHT20	4/2880	CA, TN, PA
556852	929001951433	046677556853	4.5B11/VIN/820/E12/CL/GL/DIM FBH T20	4/3240	CA, TN, PA

Cat. No.	Model No.*	UPC Code	Product Description	C/P Qty	Dist. Center
<b>B11/BA11 Candles 60W equivalent lamps dimming</b>					
575183	929003082404	046677575182	5BA11/PER/CR195WG/FR/G/E26/WGD 1CT	10/4000	CA
575175	929003094904	046677575175	5B11/PER/CR195WG/FR/G/E26/WGD 1CT	10/4320	CA
575167	929002990804	046677575168	5BA11/PER/CR195WG/FR/G/E12/WGD 1CT	10/4000	CA
575191	929003082504	046677575199	5B11/PER/CR195WG/FR/G/E12/WGD 1CT	10/4320	CA
549337	929002204504	046677549336	5.5B11/PER/927-922/CL/G/E12/WGX 1FB T20	10/4320	CA, TN, PA
549345	929002204604	046677549343	5.5B11/PER/927-922/CL/G/E26/WGX 1FB T20	10/4320	CA, TN, PA
549576	929001970104	046677549572	5.5BA11/PER/927-922/CL/G/E26/WGX 1FB T20	10/4320	TN
550250	929002051304	046677550257	5.5BA11/PER/927-922/CL/G/E12/WGX 1FB T20	10/4000	PA
549410	929002206304	046677549411	5.5B11/PER/950/CL/G/E12/DIM 1FBT20	10/4320	TN
549428	929002206404	046677549428	5.5B11/PER/950/CL/G/E26/DIM 1FBT20	10/4320	TN
557496	929002295904	046677557492	6.6BA11/PER/950/CL/G/E12/DIM 1FB T20	6/3840	CA, TN, PA
<b>F15 Candle 60W equivalent lamp dimming</b>					
547959	929002091503	046677547950	5.5F15/PER/927-922/CL/G/E26/WGX 1BC T20	4/720	CA, TN, PA
<b>B11/BA11 Candles 75W equivalent lamps dimming</b>					
557462	929002295604	046677557461	6.6BA11/PER/927-922/CL/G/E26/WGX T20	6/4320	CA, TN, PA
557470	929002295704	046677557478	6.6BA11/PER/927-922/CL/G/E12/WGX T20	6/3840	CA, TN, PA
557488	929002295804	046677557485	6.6BA11/PER/950/CL/G/E26/DIM 1FB T20	6/4320	CA, TN, PA

1. Tested to B50 L70 requirement. LED lifetime means the length of time (in hours) until half of the LED light sources maintain at least 70% of their initial lumen output (B50, L70).

\* When searching for DLC or NSF listings, please use the first 10-digits only.





Less glare through increased surface space



### Why choose UFO LED Lamps?

- Highly efficient, modern aesthetic lamp and fixture in one
- Average life rating of 15,000 hours<sup>1</sup>
- Lowers maintenance costs by reducing relamp frequency
- Contains no mercury
- Rugged plastic design

### UFO LED lamps

Catalog Number	Model Number*	UPC Code	Product Description	Case/Pallet Qty	Distribution Center
<b>UFO 75W equivalent lamps</b>					
● 561654	929002010503	046677561659	16UFO/LED/830/FR/P/ND 4/1FB	4/408	CA, TN, PA
● 561639	929002441103	046677561635	16UFO/LED/850/FR/P/ND 4/1FB	4/408	CA, TN, PA
● 545110	929002010605	046677545116	16UFO/LED/865/FR/P/ND 6/1FB	6/360	TN
<b>UFO 125W equivalent lamps</b>					
● 561662	929002010703	046677561666	26UFO/LED/830/FR/P/ND 4/1FB	4/260	CA, TN, PA
● 561647	929002441203	046677561642	26UFO/LED/850/FR/P/ND 4/1FB	4/260	CA, TN, PA
● 545137	929002010805	046677545130	26UFO/LED/865/FR/P/ND 6/1FB	6/270	TN

1. Tested to B50 L70 requirement. LED lifetime means the length of time (in hours) until half of the LED light sources maintain at least 70% of their initial lumen output (B50, L70).

2. See [www.signify.com/warranties](http://www.signify.com/warranties) for details.

\* When searching for DLC or NSF listings, please use the first 10-digits only.



Unique designs provide form factors to fit standard applications

### Why choose MasterClass Specialty LED Lamps?

- Huge energy savings when compared to halogen and incandescent lamps
- Average life rating of 15,000 hours<sup>1</sup>
- Suitable for damp applications
- Lamps in this portfolio fit a variety of applications from task lighting in hotel and restaurants, landscape lighting and are ideal for decorative and ambient applications and more



### MasterClass Specialty LED lamps

Catalog Number	Model Number*	UPC Code	Product Description	Case/Pallet Qty	Distribution Center
<b>MasterClass non-dimming lamps</b>					
● 475418	929002389636	046677475413	2T5/LED/830/ND/Wedge/12V/BC/2PK 6/2	12/4800	CA, TN, PA
● 477166	929001844003	046677477165	1T3/LED/830/G4/ND/12V 6/1BC	6/2400	CA, TN, PA
● 477174	929001844203	046677477172	2T3/LED/830/G4/ND 12V 6/1BC	6/2400	CA, TN, PA
● 477240	929001844425	046677477240	2T3/PER/830/ND/GY6.35/12V 6/1BC	6/2142	CA, TN, PA
● 533455	929002389596	046677475543	1.2T5/SPC/830/ND/12V/Wedge/BC/2PK 6/2	12/4800	CA, TN, PA
● 534263	929001840835	046677534264	3.6T3/PER/830/ND/G9/120V 6/3BC	6/1932	PA
● 465138	929001266825	046677465131	3T3/PER/830/ND/G9/120V 6/1BC	6/2142	TN
● 471946	929001357525	046677471941	7.5R7S/PER/830/ND/120V 4/1BC	4/1372	CA
● 471952	929001373325	046677471958	14R7S/PER/830/ND/120V 4/1BC	4/1176	PA
● 462977	929001224603	046677462970	BC0.5C7/LED/827/E12/ND 120V 2pk	6/1974	TN

1. Tested to B50 L70 requirement. LED lifetime means the length of time (in hours) until half of the LED light sources maintain at least 70% of their initial lumen output (B50, L70).  
\* When searching for DLC or NSF listings, please use the first 10-digits only.



80W EX39

115W EX39

150W EX39

450W EX39

**Long life lowers maintenance costs by reducing relamp frequency**



### Why choose MasterClass Corn Cob LED Lamps?

- Delivers up to 400W replacements
- Fits within industry ANSI outline offering perfect fit in all HID fixtures
- UL Type B lamps allow installer to bypass the ballast and reduce maintenance costs
- Includes additional safety cable for secure installation
- Suitable for both enclosed and open fixtures

### MasterClass Corn Cob LED lamps

Catalog Number	Model Number*	UPC Code	Product Description	Case/Pallet Qty	Distribution Center
<b>MasterClass LED corn cob</b>					
564054	929002996104	046677564056	80CC/LED/840/LS EX39 G2 BB 3/1	3/360	CA, TN, PA
564062	929002996204	046677564063	80CC/LED/850/LS EX39 G2 BB 3/1	3/360	CA, TN, PA
564070	929002996404	046677564070	115CC/LED/840/LS EX39 G2 BB 3/1	3/312	CA, TN, PA
564088	929002996504	046677564087	115CC/LED/850/LS EX39 G2 BB 3/1	3/312	CA, TN, PA
564096	929002996704	046677564094	150CC/LED/840/LS EX39 G2 BB 3/1	3/312	CA, TN, PA
564112	929002996804	046677564117	150CC/LED/850/LS EX39 G2 BB 3/1	3/312	CA, TN, PA
564732	929003019704	046677564735	450CC/LED/840/LS EX39 BB 3/1	3/60	CA, TN, PA
564740	929003019804	046677564742	450CC/LED/850/LS EX39 BB 3/1	3/60	CA, TN, PA

\* When searching for DLC or NSF listings, please use the first 10-digits only.

Offered in both mogul-based and medium-based options



### Why choose CorePro Corn Cob LED Lamps?

- Passive cooling lamps eliminate fan noise and reduce moving parts which require additional maintenance over time
- Up to 70% energy savings<sup>1</sup>
- Long life lowers maintenance costs by reducing re-lamp frequency
- UL Type B solution allows installer to bypass the ballast and reduce maintenance costs



### CorePro Corn Cob LED lamps

Catalog Number	Model Number*	UPC Code	Product Description	Case/Pallet Qty	Distribution Center
<b>CorePro LED corn cob</b>					
559633	929002395204	046677559632	18CC/LED/830/ND E26 G2 BB 6/1	6/900	CA, TN, PA
559641	929002395304	046677559649	18CC/LED/840/ND E26 G2 BB 6/1	6/900	CA, TN, PA
559658	929002395404	046677559656	18CC/LED/850/ND E26 G2 BB 6/1	6/900	CA, TN, PA
559666	929002395504	046677559663	27CC/LED/830/ND E26 G2 BB 6/1	6/720	CA, TN, PA
559674	929002395604	046677559670	27CC/LED/840/ND E26 G2 BB 6/1	6/720	CA, TN, PA
559682	929002395704	046677559687	27CC/LED/850/ND E26 G2 BB 6/1	6/720	CA, TN, PA
559690	929002395804	046677559694	36CC/LED/830/ND E26 G2 BB 6/1	6/456	CA, TN, PA
559708	929002395904	046677559700	36CC/LED/840/ND E26 G2 BB 6/1	6/456	CA, TN, PA
559716	929002396004	046677559717	36CC/LED/850/ND E26 G2 BB 6/1	6/456	CA, TN, PA
564120	929002998904	046677564124	36CC/LED/830/LS EX39 G3 BB 3/1	3/408	PA
564153	929002999004	046677564155	36CC/LED/840/LS EX39 G3 BB 3/1	3/408	PA
564161	929002999104	046677564162	36CC/LED/850/LS EX39 G3 BB 3/1	3/408	PA
564179	929002999204	046677564179	45CC/LED/830/LS EX39 G3 BB 3/1	3/306	PA
564187	929002999304	046677564186	45CC/LED/840/LS EX39 G3 BB 3/1	3/306	PA
564195	929002999404	046677564193	45CC/LED/850/LS EX39 G3 BB 3/1	3/306	PA
564203	929002999504	046677564209	54CC/LED/830/LS EX39 G3 BB 3/1	3/306	PA
564211	929002999604	046677564216	54CC/LED/840/LS EX39 G3 BB 3/1	3/306	PA
564229	929002999704	046677564223	54CC/LED/850/LS EX39 G3 BB 3/1	3/306	PA
564237	929002999804	046677564230	63CC/LED/830/LS EX39 G3 BB 3/1	3/306	PA
564245	929002999904	046677564247	63CC/LED/840/LS EX39 G3 BB 3/1	3/306	PA
564252	929003000004	046677564254	63CC/LED/850/LS EX39 G3 BB 3/1	3/306	PA

1. LED system watts of 36W compared to 120W of a C100S54/ALTO.  
 \* When searching for DLC or NSF listings, please use the first 10-digits only.

## LED Lamps

### MasterClass Corn Cob with Selectable CCT



36W EX39

45/54W EX39

63W EX39

Works on probe  
and pulse start ballasts



### Why choose MasterClass Corn Cob LED Lamps?

- Reduce & streamline inventory with three color temperatures in one lamp
- Passive cooling lamps eliminate fan noise and reduce moving parts which require additional maintenance over time
- Up to 80% energy savings<sup>1</sup>
- Long life lowers maintenance costs by reducing re-lamp frequency
- UL Type B solution allows installer to bypass the ballast and reduce maintenance costs

#### MasterClass Corn Cob LED lamps with Selectable CCT

Catalog Number	Model Number*	UPC Code	Product Description	Case/Pallet Qty	Distribution Center
MasterClass LED corn cob with Selectable CCT					
570465	929003065204	046677570460	36CC/LED/3CCT/LS EX39 G3 BB 3/1	3/408	CA, TN, PA
570473	929003065304	046677570477	45CC/LED/3CCT/LS EX39 G3 BB 3/1	3/306	PA
570481	929003065404	046677570484	54CC/LED/3CCT/LS EX39 G3 BB 3/1	3/306	CA, TN, PA
570499	929003065504	046677570491	63CC/LED/3CCT/LS EX39 G3 BB 3/1	3/306	PA

1. LED system watts of 36W compared to 120W of a C100S54/ALTO.

\* When searching for DLC or NSF listings, please use the first 10-digits only.

**Instant-on** for  
no warm-up time



105/165W EX39

145/165W EX39

## Why choose TrueForce High Bay LED Lamps?

- Easy to install and works on wide voltage (120-277V)
- Available in Ballast Bypass UL Type B as well as UL Type A options
- Wide operating temperature range for industrial applications: -40°F to 130°F (-40°C to 55°C)
- Narrow and wide beam options to ensure uniform light distribution in application
- UL Type B lamps are suitable for use in enclosed fixtures & DLC certified

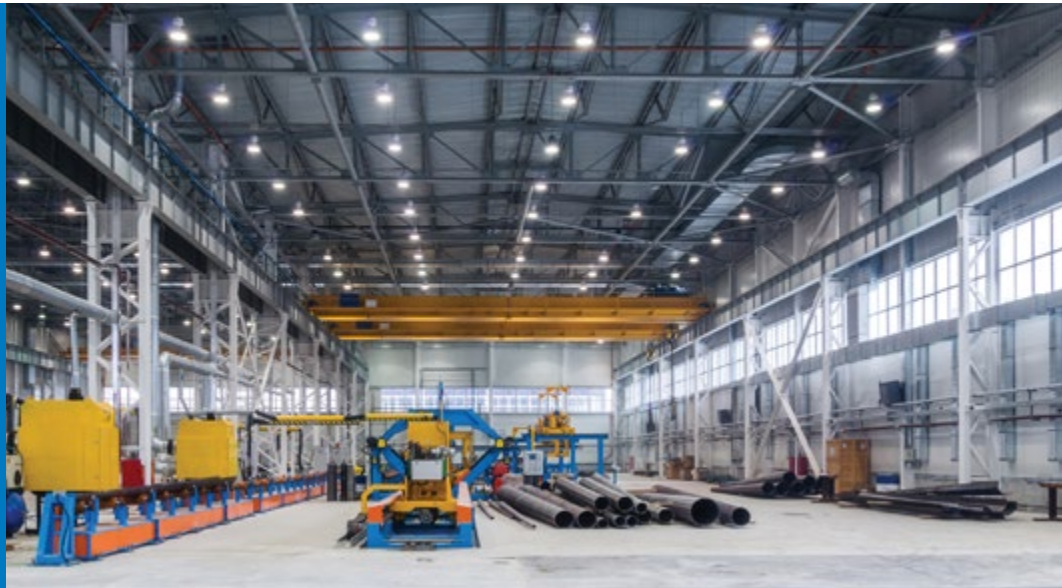

## TrueForce High Bay LED lamps

Catalog Number	Model Number*	UPC Code	Product Description	Case/Pallet Qty	Distribution Center
TrueForce LED high bay					
● 563932	929002496004	046677563936	145HB/LED/840/D NB DL BB G2 4/1	4/48	CA, TN, PA
● 563940	929002496104	046677563943	145HB/LED/840/D WB UDL BB G2 4/1	4/48	CA, TN, PA
● 563956	929002496204	046677563950	145HB/LED/850/D NB DL BB G2 4/1	4/48	CA, TN, PA
● 563964	929002496304	046677563967	145HB/LED/850/D WB UDL BB G2 4/1	4/48	CA, TN, PA
● 465609	929001264804	046677465605	165HB/LED/740/ND NB DL 2/1	2/64	PA, TN
● 465625	929001265004	046677465629	165HB/LED/740/ND WB DL 2/1	2/64	CA, TN, PA
● 465658	929001265304	046677465650	165HB/LED/840/ND NB UDL 2/1	2/64	CA, TN
● 465674	929001265504	046677465674	165HB/LED/840/ND WB UDL 2/1	2/64	CA, TN, PA
● 563972	929002496404	046677563974	165HB/LED/840/D NB DL BB G2 4/1	4/48	PA
● 563980	929002496504	046677563981	165HB/LED/840/D WB UDL BB G2 4/1	4/48	PA
● 563998	929002496604	046677563998	165HB/LED/850/D NB DL BB G2 4/1	4/48	PA
● 564005	929002496704	046677564001	165HB/LED/850/D WB UDL BB G2 4/1	4/48	PA

\* When searching for DLC or NSF listings, please use the first 10-digits only.

## LED Lamps

### CorePro High Bay/Low Bay



25W E26

38W E26

45W E26

65/75W EX39

**Works on probe  
and pulse start ballasts**



### Why choose CorePro High Bay/Low Bay LED Lamps?

- Standard EX39 base to replace E and O rated metal halide lamps
- Over temp and 4KV surge protection
- Direct wire ballast bypass lamps
- Average life rating of 25,000 hours<sup>1</sup>
- No mercury allowing for non-hazardous waste disposal
- Title 20 qualified for California applications
- 5-year limited warranty depending on operating hours<sup>2</sup>

### CorePro High Bay/Low Bay LED lamps

Catalog Number	Model Number*	UPC Code	Product Description	Case/Pallet Qty	Distribution Center
<b>CorePro LED high bay/low bay</b>					
● 547943	929001993304	046677547943	4HB/LED/Blue/ND FB 6/1	6/828	TN
● 543066	929001999104	046677543068	25HB/LED/840/ND FB 6/1	6/264	CA, TN, PA
● 541950	929001990004	046677541958	25HB/LED/850/ND BB 6/1	6/264	CA, TN, PA
● 541912	929001989604	046677541910	25HB/LED/830/ND BB 6/1	6/264	TN
● 543074	929001999204	046677543075	38HB/LED/840/ND FB 6/1	6/144	CA, TN, PA
● 541960	929001990104	046677541965	38HB/LED/850/ND BB 6/1	6/144	CA, TN, PA
● 542324	929001993104	046677542320	75HB/LED/840/ND FB 4/1	4/192	CA, TN, PA
● 542316	929001990504	046677542313	75HB/LED/850/ND FB 6/1	6/192	CA, TN, PA
● 541920	929001989704	046677541927	38HB/LED/830/ND BB 6/1	6/144	TN
● 542290	929001990304	046677542290	65HB/LED/850/ND FB 6/1	6/192	TN
● 542308	929001993004	046677542306	65HB/LED/840/ND FB 6/1	6/192	TN
● 541938	929001989804	046677541934	45HB/LED/830/ND BB 6/1	6/108	TN
● 541978	929001990204	046677541972	45HB/LED/850/ND BB 6/1	6/108	TN
● 543082	929001999304	046677543082	45HB/LED/840/ND FB 6/1	6/108	TN

1. Tested to B50 L70 requirement. LED lifetime means the length of time (in hours) until half of the LED light sources maintain at least 70% of their initial lumen output (B50, L70).

2. See [www.signify.com/warranties](http://www.signify.com/warranties) for details.

\* When searching for DLC or NSF listings, please use the first 10-digits only.

# PHILIPS

## LED Lamps

### CorePro Wall Packs

Offered in both mogul-based and medium-based options



20W E26



40W EX39



60W EX39

## Why choose CorePro Wall Pack LED Lamps?

- Flat panel design
- Passive cooling lamps eliminate fan noise and reduce moving parts which require additional maintenance over time
- Up to 79% energy savings<sup>1</sup>
- UL Type B solution allows installer to bypass the ballast and reduce maintenance cost
- Wide ambient temperature operating range from -30°C to 55°C



## Wall Pack LED lamps

Catalog Number	Model Number*	UPC Code	Product Description	Case/Pallet Qty	Distribution Center
LED wall pack lamps					
559906	929002397904	046677559908	20WP/LED/830/ND E26 G2 BB 6/1	6/510	TN
559914	929002398004	046677559915	20WP/LED/840/ND E26 G2 BB 6/1	6/510	TN
559922	929002398104	046677559922	20WP/LED/850/ND E26 G2 BB 6/1	6/510	TN
564260	929003000104	046677564261	40WP/LED/840/LS EX39 G3 BB 3/1	3/360	PA
564278	929003000204	046677564278	40WP/LED/850/LS EX39 G3 BB 3/1	3/360	PA
564286	929003000304	046677564285	60WP/LED/840/LS EX39 G3 BB 3/1	3/270	PA
564294	929003000404	046677564292	60WP/LED/850/LS EX39 G3 BB 3/1	3/270	PA

1. LED system watts of 40W compared to 195 system watts of an HID lamp.  
 \* When searching for DLC or NSF listings, please use the first 10-digits only.





**Optically efficient,**  
emits light towards  
usage direction



### Why choose TrueForce Post Top LED Lamps?

- Energy savings up to 75% when compared to traditional HID lamps
- Reliable lifetime up to 50,000 hours<sup>1</sup>
- Right lamp size and lighting distribution for direct retrofit with a peace of mind
- Direct LED replacement solution without changing the fixture
- Pleasant white light with CRI 70

### TrueForce Post Top LED lamps

Catalog Number	Model Number*	UPC Code	Product Description	Case/Pallet Qty	Distribution Center
<b>CorePro LED post top</b>					
● 473579	929001396204	046677473570	26ED23.5/LED/730/ND 120-277V G2 4/1	4/600	CA, TN
● 473587	929001396304	046677473587	26ED23.5/LED/740/ND 120-277V G2 4/1	4/600	TN
● 473595	929001396404	046677473594	26ED23.5/LED/727/ND 120-277V G2 4/1	4/600	TN
● 473603	929001396504	046677473600	35ED23.5/LED/730/ND 120-277V G2 4/1	4/600	TN
● 473611	929001396604	046677473617	35ED23.5/LED/740/ND 120-277V G2 4/1	4/600	TN
● 473629	929001396704	046677473624	35ED23.5/LED/727/ND 120-277V G2 4/1	4/600	TN
● 473637	929001396804	046677473631	55ED28/LED/730/ND 120-277V G2 4/1	4/400	CA, TN
● 473645	929001396904	046677473648	55ED28/LED/740/ND 120-277V G2 4/1	4/400	CA, TN
● 473652	929001397004	046677473655	55ED28/LED/727/ND 120-277V G2 4/1	4/400	TN

1. Tested to B50 L70 requirement. LED lifetime means the length of time (in hours) until half of the LED light sources maintain at least 70% of their initial lumen output (B50, L70).

\* When searching for DLC or NSF listings, please use the first 10-digits only.

# Conventional lamps

## Philips

- CFL Integrated
- CFL Pin-Based
- Fluorescent
- Halogen
- HID
- Incandescent

## CFL Lamps

### Integrated Compact Fluorescent



### Why choose Integrated CFL Lamps?

- Shape and size similar to an incandescent A19
- Fits into incandescent fixtures
- Available in a wide variety of color temperatures
- Energy saving replacement for incandescent bulbs

### Integrated Compact Fluorescent (CFL) lamps

Catalog Number	Model Number	UPC Code	Product Description	Base	Lumens	CCT (K)	Case/Pallet Qty	Distribution Center
<b>GU24 Compact Fluorescent</b>								
● 454199	929689791101	046677454197	EL/mdTQS 13W GU24	GU24	900	2,700	6/3360	TN
● 454165	929689791201	046677454166	EL/mdTQS 13W GU24 4100K	GU24	900	4,100	6/2226	TN
● 454207	929689791301	046677454203	EL/mdTQS 18W GU24	GU24	1250	2,700	6/1890	PA, CA, TN
● 454215	929689791501	046677454210	EL/mdTQS 23W GU24	GU24	1600	2,700	6/1872	PA
<b>Compact Fluorescent Twister</b>								
● 414086	929689022201	046677414085	EL/mdTQS 26W T2 4.1K	Medium Screw	1800	4,100	6/1632	TN
● 414094	929689022301	046677414092	EL/mdTQS 26W T2 5K	Medium Screw	1700	5,000	6/1632	PA
● 413996	929689749502	046677413996	EL/mdTQ 13W T2	Medium Screw	900	2,700	6/2700	PA, CA, TN
● 414011	929689749901	046677414016	EL/mdTQ 23W T2	Medium Screw	1600	2,700	6/1872	PA, CA, TN
● 414045	929689799204	046677414047	EL/mdTQ 13W T2 5k	Medium Screw	860	5,000	6/2700	TN
● 414078	929689799304	046677414078	EL/mdTQ 23W T2 5k	Medium Screw	1500	5,000	6/1332	TN
● 414037	929689799501	046677414030	EL/mdTQ 13W T2 4.1k	Medium Screw	900	4,100	6/2700	PA, CA, TN
● 414052	929689799601	046677414054	EL/mdTQ 23W T2 3.5k	Medium Screw	1600	3,500	6/1332	PA
● 414060	929689799701	046677414061	EL/mdTQ 23W T2 4.1k	Medium Screw	1600	4,100	6/1872	PA, CA, TN

● Stock Ready (returnable)

## CFL Lamps

### Pin-Based Compact Fluorescent



## Why choose Pin-Based CFL Lamps?

- Broad range of color temperatures available in 2700K, 3500K and 4100K
- Extended relamping cycles with up to 20,000 hours rated average life (based on 12 hours per start)
- High light output in a compact size with 80%+ lumen maintenance
- Energy saving system available without changing a ballast



## Pin-Based Compact Fluorescent (CFL) lamps

Catalog Number	Model Number	UPC Code	Product Description	Base	Lumens	CCT (K)	Case/Pallet Qty	Distribution Center
<b>PL-S 2-pin Compact Fluorescent</b>								
146712	927900682721	046677146719	PL-S 5W/827/2P/ALTO	G23	250	2,700	10/3250	PA, TN
148718	927901282721	046677148713	PL-S 7W/827/2P/ALTO	G23	400	2,700	10/8960	PA
148734	927901284121	046677148737	PL-S 7W/841/2P/ALTO	G23	400	4,100	10/3300	PA
148676	927901882721	046677148676	PL-S 9W/827/2P/ALTO	G23	600	2,700	10/7420	PA, CA, TN
148700	927901884121	046677148706	PL-S 9W/841/2P/ALTO	G23	600	4,100	10/7420	PA, CA, TN
146811	927902782721	046677146818	PL-S 13W/827/2P/ALTO	GX23	825	2,700	10/6720	PA, CA, TN
146845	927902783521	046677146849	PL-S 13W/835/2P/ALTO	GX23	825	3,500	10/6720	PA, CA, TN
146852	927902784121	046677146856	PL-S 13W/841/2P/ALTO	GX23	825	4,100	10/6720	PA, CA, TN
146878	927902785021	046677146870	PL-S 13W/850/2P/ALTO	GX23	800	5,000	10/6720	PA, CA, TN
<b>PL-C 2-pin Compact Fluorescent</b>								
383109	927904982730	046677109530	PL-C ALTO 13W/827 GX23-2 /2P 1CT	GX23-2	860	2,700	10/5250	PA, CA, TN
383125	927904983530	046677111618	PL-C ALTO 13W/835 GX23-2 /2P 1CT	GX23-2	860	-	10/5250	PA, TN
383133	927904984030	046677110987	PL-C ALTO 13W/841 GX23-2 /2P 1CT	GX23-2	860	4,000	10/5250	PA, TN
383186	927905782730	046677109547	PL-C 18W/827/2P/ALTO 10PK	G24D-2	1250	-	10/4500	TN
383182	927905783530	046677111632	PL-C 18W/835/2P/ALTO 10PK	G24D-2	1250	-	10/4500	PA, CA, TN
383190	927905784030	046677111663	PL-C 18W/841/2P/ALTO 10PK	G24D-2	1250	-	10/4500	TN
383216	927906182730	046677109554	PL-C 26W/827/2P/ALTO 10PK	G24D-3	1800	-	10/3750	PA, TN
383224	927906183030	046677114947	PL-C26W/830/2P/ALTO 10PK	G24D-3	1800	-	10/3750	PA
383232	927906183530	046677111649	PL-C 26W/835/2P/ALTO 10PK	G24D-3	1800	3,500	10/3750	PA, TN
383240	927906184030	046677111670	PL-C 26W/841/2P/ALTO 10PK	G24D-3	1800	-	10/3750	PA, CA, TN

● Stock Ready (returnable)

## CFL Lamps

### Pin-Based Compact Fluorescent

(continued)



Catalog Number	Model Number	UPC Code	Product Description	Base	Lumens	CCT (K)	Case/Pallet Qty	Distribution Center
<b>PL-C 4-pin Compact Fluorescent</b>								
383257	927907182730	046677110727	PL-C 13W/827/4P/ALTO 10PK	G24Q-1	900	2,700	10/4500	PA, TN
383265	927907183030	046677359348	PL-C 13W/830/4P/ALTO 10PK	G24Q-1	900	-	10/4500	PA, TN
383273	927907183530	046677237745	PL-C 13W/835/4P/ALTO 10PK	G24Q-1	900	3,500	10/4500	PA, CA, TN
383281	927907184030	046677240004	PL-C 13W/841/4P/ALTO 10PK	G24Q-1	900	4,000	10/4500	PA, CA, TN
383299	927907282730	046677110734	PL-C 18W/827/4P/ALTO 10PK	G24Q-2	1250	2,700	10/4500	PA, CA, TN
383307	927907283030	046677359355	PL-C 18W/830/4P/ALTO 10PK	G24Q-2	1250	-	10/4500	PA, TN
383323	927907283530	046677240042	PL-C 18W/835/4P/ALTO 10PK	G24Q-2	1250	3,500	10/4500	PA, CA, TN
383331	927907284030	046677240059	PL-C 18W/841/4P/ALTO 10PK	G24Q-2	1200	-	10/4500	PA, CA, TN
220418	927906884020	046677220419	PL-C 18W/841/XEW/4P/ALTO 14W	GX24Q-2	1,100	4,000	10/5250	PA, CA, TN
383372	927907384030	046677111779	PL-C 26W/41/4P/ALTO 10PK	G24Q-3	1800	4,000	10/3750	PA, CA, TN
383349	927907382730	046677110741	PL-C 26W/827/4P/ALTO 10PK	G24Q-3	1800	2,700	10/3750	PA, CA, TN
383356	927907383030	046677240257	PL-C 26W/830/4P/ALTO 10PK	G24Q-3	1800	-	10/3750	PA, TN
383364	927907383530	046677111748	PL-C 26W/835/4P/ALTO 10PK	G24Q-3	1800	3,500	10/5250	PA, CA, TN
220475	927906783520	046677220471	PL-C 26W/835/XEW/4P/ALTO 21W	GX24Q-3	1,525	3,500	10/5250	PA
<b>PL-L 4-pin Compact Fluorescent</b>								
345009	927903108321	046677345006	PL-L 18W/830/4P	2G11	1,250	3,000	25/4000	PA
359323	927903183521	046677359324	PL-L 18W/835/4P	2G11	1,250	3,500	25/4000	PA, CA
345017	927903108421	046677345013	PL-L 18W/841/4P	2G11	1,250	4,100	25/1200	PA
345058	927903308321	046677345051	PL-L 24W/830/4P	2G11	1,800	3,000	25/2600	PA, TN
359331	927903383521	046677359331	PL-L 24W/835/4P	2G11	1,800	3,500	25/800	PA
345082	927903308421	046677345082	PL-L 24W/841/4P	2G11	1,800	4,000	25/800	TN
345116	927904508321	046677345112	PL-L 36W/830/4P	2G11	2,900	3,000	25/2000	PA
349423	927904583521	046677349424	PL-L 36W/835/4P	2G11	2,900	3,500	25/2000	PA, TN
345132	927904508421	046677345136	PL-L 36W/841/4P	2G11	2,900	4,000	25/2000	PA, TN
300426	927908008329	046677111786	PL-L 40W/830/4P/RS/IS	2G11	3,300	3,000	25/1750	PA, TN
209130	927908383021	046677209131	PL-L 40W/830/XEW/4P/IS 25W	2G11	2,600	3,000	25/1750	PA
300434	927908083529	046677111793	PL-L 40W/835/4P/RS/IS	2G11	3,300	3,500	25/1750	PA, CA, TN
209148	927908383521	046677209148	PL-L 40W/835/XEW/4P/IS 25W	2G11	2,600	3,500	25/1750	PA
300442	927908008429	046677111809	PL-L 40W/841/4P/RS/IS	2G11	3,300	4,000	25/1750	PA, CA, TN
209155	927908384121	046677209155	PL-L 40W/841/XEW/4P/IS 25W	2G11	2,600	4,100	25/400	PA
347534	927908583527	046677112684	PL-L 50W/835/4P/RS	2G11	4,300	3,500	25/1750	PA, CA
347708	927908508427	046677347703	PL-L 50W/841/4P/RS	2G11	4,300	4,100	25/1750	PA, CA, TN
<b>PL-T 4-pin Compact Fluorescent</b>								
458216	927910583050	046677268022	PL-T 18W/830/A/4P/ALTO	GX24Q-3	1200	3,000	10/1500	PA
458224	927910583550	046677268206	PL-T 18W/835/A/4P/ALTO	GX24Q-2	1200	3,500	10/3280	PA, TN
458232	927910584150	046677268220	PL-T 18W/841/A/4P/ALTO	GX24Q-2	1200	4,100	10/1500	PA
458240	927910982750	046677384401	PL-T 26W/827/A/4P/ALTO	GX24Q-3	1800	2,700	10/1500	PA, TN
458257	927910983050	046677268237	PL-T 26W/830/A/4P/ALTO	GX24Q-3	1800	3,000	10/3280	PA
458265	927910983550	046677268244	PL-T 26W/835/A/4P/ALTO	GX24Q-3	1800	3,500	10/3280	PA, CA, TN
458273	927910984150	046677268251	PL-T 26W/841/A/4P/ALTO	GX24Q-3	1800	4,100	10/3280	PA, CA, TN
458281	927911082750	046677384432	PL-T 32W/827/A/4P/ALTO	GX24Q-3	2400	2,700	10/2870	PA, TN
458299	927911083050	046677268329	PL-T 32W/830/A/4P/ALTO	GX24Q-3	2400	3,000	10/2870	PA, CA, TN
220210	927906983020	046677220211	PL-T 32W/830/XEWA/4P/ALTO 27W	GX24Q-3	1,875	3,000	10/2870	PA, TN
458307	927911083550	046677268336	PL-T 32W/835/A/4P/ALTO	GX24Q-3	2400	3,500	10/2870	PA, CA, TN
220228	927906983520	046677220228	PL-T 32W/835/XEWA/4P/ALTO 27W	GX24Q-3	1,875	3,500	10/2870	PA, CA, TN
458315	927911084150	046677268725	PL-T 32W/841/A/4P/ALTO	GX24Q-3	2400	4,100	10/2870	PA, CA, TN
149005	927911482720	046677149000	PL-T 42W/827/A/4P/ALTO	GX24Q-4	3200	2,700	10/2460	PA, CA, TN
149013	927911483020	046677149017	PL-T 42W/830/A/4P/ALTO	GX24Q-4	3200	3,000	10/2460	PA, TN
149021	927911483520	046677149024	PL-T 42W/835/A/4P/ALTO	GX24Q-4	3200	3,500	10/2460	PA, CA, TN
220285	927908183520	046677220280	PL-T 42W/835/XEWA/4P/ALTO 33W	GX24Q-4	2,615	3,500	10/2460	PA, TN
149039	927911484120	046677149031	PL-T 42W/841/A/4P/ALTO	GX24Q-4	2720	-	10/2460	PA, CA, TN
146324	927914083520	046677146320	PL-T 57W/835/A/4P	GX24Q-5	4,300	3,500	10/2050	PA
146332	927914084020	046677146337	PL-T 57W/841/A/4P	GX24Q-5	4,300	4,100	10/2050	PA, TN

● Stock Ready (returnable)

## CFL Tubes

### T5, T8 & T12 Compact Fluorescent



### Why choose T5, T8 & T12 CFL Tubes?

- Outstanding lumen performance with 95% lumen maintenance
- Long life lamps available with up to 90K hours (based on 12 hour per start, operated on program start ballasts for Twice the Life lamps)
- Operates on existing ANSI ballasts and fits into existing fixtures
- 4' T8 lamp family contains only 1.7mg of mercury
- 25W and 28W energy saving products available for 4' T8 replacement options



### T5, T8 & T12 Compact Fluorescent (CFL) lamps

Catalog Number	Model Number	UPC Code	Product Description	Base	Lumens	CCT (K)	Case/Pallet Qty	Dist. Center
<b>T12 Linear Fluorescent Lamp</b>								
141499	927882003311	046677141493	F15T12/CW 30PK	Medium Bipin	800	4,100	30/600	PA, TN
273490	927883002901	046677273491	F20T12/WW ALTO 30PK	Medium Bipin	1,250	3,000	30/1440	PA
273326	927883003301	046677273323	F20T12/CW ALTO 30PK	Medium Bipin	1,200	4,200	30/1440	PA, CA, TN
273284	927883005405	046677273286	F20T12/D ALTO 30PK	Medium Bipin	1,075	6,500	30/1440	PA, CA, TN
132217	927886002905	046677132217	F30T12/WW/RS ALTO 30PK	Medium Bipin	2,300	3,000	30/720	PA
272427	927886003305	046677272425	F30T12/CW/RS ALTO 30PK	Medium Bipin	2,250	4,100	30/720	PA, CA, TN
376491	927886005403	046677376499	F30T12/D/RS ALTO 30PK	Medium Bipin	1,950	6,300	30/720	PA, CA, TN
423129	927887803704	046677423124	F40T12/CWSupreme/PLUS/ALTO 30PK	Medium Bipin	2550	4,100	30/720	PA, CA, TN
423889	927887803901	046677423889	F40T12/CWSupreme/ALTO	Medium Bipin	2600	4,100	30/720	PA, CA, TN
424002	927887803902	046677424008	F40T12/CWSupreme/ALTO TG	Medium Bipin	2250	4,100	30/480	PA, CA, TN
423897	927888000213	046677423896	F40T12/C50Supreme/ALTO 30pk	Medium Bipin	2500	5,100	30/720	PA, CA, TN
423186	927888004904	046677423186	F40T12/NX/ALTO 30PK	Medium Bipin	2200	3,500	30/720	PA, CA, TN
423103	927888004905	046677423100	F40T12/NX/ALTO TG 30PK	Medium Bipin	2200	3,500	30/480	TN
273599	927888005709	046677273590	F40DX ALTO 30PK	Medium Bipin	2,325	6,500	30/720	PA, CA, TN
363218	927890003304	046677363215	F48T12/CW ALTO 15PK	Medium Bipin	2,950	4,100	15/675	PA
369785	927890203305	046677369781	F48T12/CW/HO ALTO 15PK	Recessed Double Contact	4,050	4,100	15/675	PA, CA, TN
162966	927890203309	046677162962	F48T12/CW/HO ALTO TG 15PK	Recessed Double Contact	4,050	4,100	15/480	PA, TN
369843	927890205402	046677369842	F48T12/D/HO ALTO 15PK	Single Pin	3,400	6,500	15/675	PA, CA, TN
234310	927891303301	046677234317	F60T12 CW HO ALTO	Recessed Double Contact	5,150	4,100	15/675	PA, CA, TN
369892	927893003308	046677369897	F72T12/CW/HO ALTO 15PK	Single Pin	4,450	4,200	15/675	PA, CA, TN
366518	927893203304	046677366513	F72T12/CW/HO ALTO 15PK	Single Pin	6,350	4,100	15/675	PA, CA, TN
366534	927893205402	046677366537	F72T12/D/HO ALTO 15PK	Single Pin	5,600	6,500	15/675	PA, CA, TN
234484	927894403301	046677234485	F84T12 CW HO ALTO 1LP	Recessed Double Contact	7,800	4,100	15/675	PA
214890	927894705701	046677214890	F96T12/DX/HO/ALTO 15PK	Recessed Double Contact	6,750	6,500	15/675	PA, CA, TN
423871	927895000211	046677423872	F96T12/C50Supreme/ALTO 15pk	Single Pin	5000	5,100	15/675	PA, CA, TN
423194	927895003704	046677423193	F96T12/CW Supreme/ALTO 15PK	Single Pin	5000	4,100	15/675	PA, CA, TN
423160	927895003705	046677423162	F96T12/CW Supreme/ALTO TG 15PK	Single Pin	5000	4,100	15/675	TN
423053	927895004902	046677423056	F96T12/NX/ALTO 15pk	Single Pin	5000	3,500	15/675	PA
372821	927895005711	046677372828	F96T12/DX ALTO 15PK	Single Pin	4,500	6,500	15/675	PA, CA, TN

• Stock Ready (returnable)

## CFL Tubes

## T5, T8 & T12 Compact Fluorescent

(continued)



Catalog Number	Model Number	UPC Code	Product Description	Base	Lumens	CCT (K)	Case/Pallet Qty	Dist. Center
<b>T12 Linear Fluorescent Lamp (continued)</b>								
● 381764	927895203323	046677381769	TL F96T12/CW/HO-O ALTO 110W FLUOR. LAMP	Single Pin	8,800	4,100	15/675	PA, CA, TN
● 163014	927895203332	046677163013	F96T12/CW/HO-O ALTO TG 15PK	Single Pin	8,800	4,100	15/600	TN
● 381774	927895205408	046677381776	F96T12/D/HO-O ALTO 15PK	Recessed Double Contact	7,800	6,500	15/675	PA, CA, TN
● 381774	927895205408	046677381776	F96T12/D/HO-O ALTO 15PK	Recessed Double Contact	7,800	6,500	15/675	PA, CA, TN
<b>T12 U bent Fluorescent Lamp</b>								
● 423087	927862003702	046677423087	FB40/T12/CW Supreme/6 12PK	Medium Bipin	2,300	4,100	12/240	PA, CA, TN
● 423095	927862004902	046677423094	FB40/T12/NX/6 12PK	Medium Bipin	2,300	3,500	12/300	PA, CA, TN
● 219931	927862005704	046677219932	FB40DX/6 12PK	Medium Bipin	2,250	6,500	12/240	PA, CA, TN
<b>T8 Linear Fluorescent Lamp</b>								
● 281477	927825403326	046677281472	F30T8/CW ALTO 30PK	Medium Bipin	2,200	4,100	30/1440	PA, CA, TN
● 281881	927850083503	046677281885	F17T8/TL835/ALTO 30PK	Medium Bipin	1,400	3,500	30/2100	PA, CA, TN
● 281899	927850084102	046677281892	F17T8/TL841/ALTO 30PK	Medium Bipin	1,400	4,100	30/2100	PA, CA, TN
● 280909	927850085003	046677280901	F17T8/TL850 ALTO 30PK	Medium Bipin	1,350	5,000	30/2880	PA, TN
● 280933	927850183003	046677280932	F17T8/TL830/PLUS/ALTO 30PK	Medium Bipin	1,400	3,000	30/2100	PA, CA, TN
● 280941	927850183503	046677280949	F17T8/TL835/PLUS/ALTO 30PK	Medium Bipin	1,400	3,500	30/2100	PA, CA, TN
● 280958	927850184103	046677280956	F17T8/TL841/PLUS/ALTO 30PK	Medium Bipin	1,400	4,100	30/2100	PA, CA, TN
● 280966	927850185002	046677280963	F17T8/TL850/PLUS/ALTO 30PK	Medium Bipin	1,300	5,000	30/2100	PA, CA, TN
● 281931	927850186502	046677281939	F17T8/TL865 PLUS/ALTO 30PK	Medium Bipin	1,300	6,500	30/2880	PA, CA, TN
● 281907	927851083503	046677281908	F25T8/TL835/ALTO 30PK	Medium Bipin	2,225	3,500	30/1260	PA, CA, TN
● 281915	927851084102	046677281915	F25T8/TL841/ALTO 30PK	Medium Bipin	2,225	4,100	30/1260	PA, CA, TN
● 280925	927851085002	046677280925	F25T8/TL850 ALTO 30PK	Medium Bipin	2,175	5,000	30/1440	PA, TN
● 280974	927851183002	046677280970	F25T8/TL830/PLUS/ALTO 30PK	Medium Bipin	2,225	3,000	30/1260	PA, CA, TN
● 280982	927851183502	046677280987	F25T8/TL835/PLUS/ALTO 30PK	Medium Bipin	2,225	3,500	30/1440	PA, CA, TN
● 280990	927851184102	046677280994	F25T8/TL841/PLUS/ALTO 30PK	Medium Bipin	2,225	4,100	30/1440	PA, CA, TN
● 281659	927852083002	046677281656	F32T8/TL830 PLUS ALTO HV 30PK	Medium Bipin	2,950	3,000	30/1050	PA, CA, TN
● 281675	927852083503	046677281670	F32T8/TL835 PLUS ALTO 30PK	Medium Bipin	2,950	3,500	30/1050	PA, CA, TN
● 283457	927852083504	046677283452	F32T8/TL835 PLUS ALTO TG 30PK	Medium Bipin	2,950	3,500	30/900	TN
● 281790	927852084104	046677281793	F32T8/TL841 PLUS ALTO HV 30PK	Medium Bipin	2,950	4,100	30/1050	PA, CA, TN
● 283465	927852084105	046677283469	F32T8/TL841 PLUS ALTO TG 30PK	Medium Bipin	2,950	4,100	30/900	TN
● 281816	927852085002	046677281816	F32T8/TL850 PLUS ALTO HV 30PK	Medium Bipin	2,950	5,000	30/1050	PA, CA, TN
● 283473	927852085003	046677283476	F32T8/TL850 PLUS ALTO TG 30PK	Medium Bipin	2,950	5,000	30/1440	PA, TN
● 281014	927852283103	046677281014	F32T8/ADV830/EW/ALTO 28W 30PK	Medium Bipin	2,700	3,000	30/1440	PA, CA, TN
● 281022	927852283603	046677281021	F32T8/ADV835/EW/ALTO 28W 30PK	Medium Bipin	2,700	3,500	30/1200	PA, CA, TN
● 281030	927852284204	046677281038	F32T8/ADV841/EW/ALTO 28W 30PK	Medium Bipin	2,700	4,100	30/1200	PA, CA, TN
● 281055	927852285103	046677281052	F32T8/ADV850/EW/ALTO 28W 30PK	Medium Bipin	2,600	5,000	30/1440	PA, CA, TN
● 282046	927852383103	046677282042	F32T8/ADV830/XEW/ALTO 25W 30PK	Medium Bipin	2,400	3,000	30/1440	TN
● 282095	927852383603	046677282097	F32T8/ADV835/XEW/ALTO 25W 30PK	Medium Bipin	2,400	3,500	30/1200	PA, CA, TN
● 280784	927852384203	046677280789	F32T8/ADV841/XEW/ALTO 25W 30PK	Medium Bipin	2,400	4,100	30/1200	PA, CA, TN
● 280792	927852385103	046677280796	F32T8/ADV850/XEW/ALTO 25W 30PK	Medium Bipin	2,400	5,000	30/1440	PA, CA, TN
● 281220	927852583603	046677281229	F32T8/ADV835/XLL ALTO 25W	Medium Bipin	2,400	3,500	30/1440	PA, CA, TN
● 281238	927852584204	046677281236	F32T8/ADV841/X LL ALTO 25W	Medium Bipin	2,400	4,100	30/1440	PA, TN
● 281253	927852585103	046677281250	F32T8/ADV850/X LL ALTO 25W	Medium Bipin	2,400	5,000	30/1440	PA, CA, TN
● 424200	927852684201	046677424206	F32T8/VEA841/XEW ALTO 25W	Medium Bipin	2,300	4,100	30/1440	PA, TN
● 424192	927852784201	046677424190	F32T8/VEA841/EW/ALTO 28W	Medium Bipin	2,600	4,100	30/1440	PA, CA, TN
● 434027	927853283601	046677434021	F32T8/ADV835/2XL/ALTO II 28W 30PK	Medium Bipin	2,650	3,500	30/1440	TN
● 434035	927853284201	046677434038	F32T8/ADV841/2XL/ALTO II 28W 30PK	Medium Bipin	2,650	4,100	30/1440	PA, CA, TN
● 434043	927853285001	046677434045	F32T8/ADV850/2XL/ALTO II 28W 30PK	Medium Bipin	2,600	5,000	30/1440	PA, CA, TN
● 433952	927853483101	046677433956	F32T8/ADV830/2XL/ALTO II 25W 30PK	Medium Bipin	2,400	3,000	30/1440	PA
● 433960	927853483601	046677433963	F32T8/ADV835/2XL/ALTO II 25W 30PK	Medium Bipin	2,400	3,500	30/1200	PA
● 433978	927853484201	046677433970	F32T8/ADV841/2XL/ALTO II 25W 30PK	Medium Bipin	2,400	4,100	30/1200	PA, TN
● 433986	927853485001	046677433987	F32T8/ADV850/2XL/ALTO II 25W 30PK	Medium Bipin	2,350	5,000	30/1440	TN
● 280800	927869783102	046677280802	F32T8/ADV830 ALTO 30PK	Medium Bipin	2,950	3,000	30/1050	PA, CA, TN
● 280818	927869783603	046677280819	F32T8/ADV835 ALTO 30PK	Medium Bipin	2,950	3,500	30/1050	PA, CA, TN
● 280859	927869784203	046677280857	F32T8/ADV841 ALTO 30PK	Medium Bipin	2,950	4,100	30/1050	PA, CA, TN
● 280891	927869785102	046677280895	F32T8/ADV850 ALTO 30PK	Medium Bipin	2,950	5,000	30/1440	PA, CA, TN
● 283291	927869785103	046677283292	F32T8/ADV850 ALTO TG 30PK	Medium Bipin	3,000	5,000	30/900	TN
● 368340	927870583501	046677368340	F40T8/TL835 ALTO 25PK	Medium Bipin	3,775	3,500	25/1200	PA, CA
● 368472	927870584101	046677368470	F40T8/TL841 ALTO 25PK	Medium Bipin	3,775	4,100	25/1200	PA, TN
● 236794	927871084104	046677236793	F48T8/TL841/HO ALTO 25/1	Recessed Double Contact	4,000	4,100	25/1200	PA, CA, TN
● 281485	927871183602	046677281489	F32T8/ADV835/XLL/ALTO 28W	Medium Bipin	2,700	3,500	30/1440	TN
● 281279	927871184202	046677281274	F32T8/ADV841/XLL/ALTO 28W 30/1	Medium Bipin	2,725	4,100	30/1440	PA, CA, TN
● 281287	927871185102	046677281281	F32T8/ADV850/XLL/ALTO 28W 30/1	Medium Bipin	2,675	5,000	30/1440	PA
● 479626	927871203901	046677479626	F32T8/TL941/ALTO 30PK	Medium Bipin	2,600	4,100	30/1050	PA, CA, TN
● 536508	927871203913	046677536503	F32T8/TL941/ALTO TG 30PK	Medium Bipin	2,600	4,100	30/1440	PA, CA, TN
● 479600	927871204901	046677479602	F32T8/TL935/ALTO 30PK	Medium Bipin	2,625	3,500	30/1050	PA, CA, TN
● 536490	927871204905	046677536497	F32T8/TL935/ALTO TG 30PK	Medium Bipin	2,625	3,500	30/1440	PA, TN
● 479592	927871205101	046677479596	F32T8/TL930/ALTO 30PK	Medium Bipin	2,775	3,000	30/1050	PA, CA, TN
● 479634	927871205501	046677479633	F32T8/TL950/ALTO 30PK	Medium Bipin	2,600	5,000	30/1050	PA, CA, TN
● 536516	927871205506	046677536510	F32T8/TL950/ALTO TG 30PK	Medium Bipin	2,600	5,000	30/1440	PA, CA, TN

● Stock Ready (returnable)

## CFL Tubes

### T5, T8 & T12 Compact Fluorescent



(continued)

Catalog Number	Model Number	UPC Code	Product Description	Base	Lumens	CCT (K)	Case/Pallet Qty	Dist. Center
479642	927871205701	046677479640	F32T8/TL965/ALTO 30PK	Medium Bipin	2600	6,500	30/1050	PA, CA, TN
536482	927871205708	046677536480	F32T8/TL965/ALTO TG 30PK	Medium Bipin	2600	6,500	30/1440	TN
<b>T8 Linear Fluorescent Lamp (continued)</b>								
236877	927874083505	046677236878	F96T8/TL835/HO/ PLUS ALTO	Recessed Double Contact	8,200	3,500	25/1200	PA
236885	927874084105	046677236885	F96T8/TL841/HO/PLUS ALTO 25/1	Recessed Double Contact	8,200	4,100	25/1200	PA, CA, TN
236893	927874085005	046677236892	F96T8/TL850/PLUS/HO/ALTO 25/1	Recessed Double Contact	8,100	5,000	25/1200	PA, CA, TN
236844	927874583505	046677236847	F96T8/TL835 PLUS ALTO 25/1	Medium Bipin	5,700	3,500	25/1200	PA, TN
236851	927874584106	046677236854	F96T8/TL841 PLUS ALTO 25/1	Medium Bipin	5,900	4,100	25/1200	PA, CA, TN
409094	927874584108	046677409098	F96T8/TL841 PLUS/ALTO TG 25PK	Medium Bipin	5,900	4,100	25/1200	TN
236869	927874585008	046677236861	F96T8/TL850 PLUS ALTO 25/1	Medium Bipin	5,780	5,000	25/1200	PA, CA, TN
209056	927942009520	046677209056	F32T8/TL950 SLV	Medium Bipin	2,000	5,000	25/1400	PA, CA, TN
407197	928022803325	046677367206	F15T8/CW 25PK	Medium Bipin	870	4,100	25/4000	PA, CA, TN
407205	928022805425	046677378233	F15T8/D 25PK	Medium Bipin	750	6,500	25/4000	PA, TN
<b>T8 U bent Fluorescent Lamp</b>								
378976	927860083002	046677378974	FB32T8/TL830/6 ALTO 20PK	Medium Bipin	2,800	3,000	20/400	PA, CA, TN
379008	927860083502	046677379001	FB32T8/TL835/6 ALTO 20PK	Medium Bipin	2,800	3,500	20/400	PA, CA, TN
379024	927860084102	046677379025	FB32T8/TL841/6 ALTO 20PK	Medium Bipin	2,800	4,100	20/400	PA, CA, TN
378802	927860085003	046677378806	FB32T8/TL850/6 ALTO 20PK	Medium Bipin	2,750	5,000	20/400	PA, CA, TN
204214	927860183601	046677204211	FB32T8/ADV835/6/XEW/ALTO 25W	Medium Bipin	2,400	3,500	20/400	PA
204230	927860184201	046677204235	FB32T8/ADV841/6/XEW/ALTO 25W	Medium Bipin	2,400	4,100	20/400	PA, CA, TN
204248	927860185101	046677204242	FB32T8/ADV850/6/XEW/ALTO 25W	Medium Bipin	2,350	5,000	20/400	PA
226712	927861283002	046677226718	FB31T8/TL830/ALTO 15/1	Medium Bipin	2,775	3,000	15/1080	PA
226720	927861283502	046677226725	FB31T8/TL835/ALTO 15/1	Medium Bipin	2,775	3,500	15/840	PA, CA, TN
226746	927861284101	046677226749	FB31T8/TL841/ALTO 15/1	Medium Bipin	2,775	4,100	15/840	PA, CA, TN
226761	927861383502	046677226763	FB29T8/TL835/EW/ALTO 15/1	Medium Bipin	2,775	3,500	15/840	PA
226779	927861384102	046677226770	FB29T8/TL841/EW/ALTO 15/1	Medium Bipin	2,775	4,100	15/1080	TN
<b>T5 Linear Fluorescent Lamp</b>								
162982	927893184102	046677162986	F54T5/841/HO/ALTO TG 40PK	Miniature Bipin	5,000	4,000	40/1000	PA, CA, TN
166868	927893185001	046677166861	F54T5/850/HO/ALTO TG	Miniature Bipin	5,000	5,000	40/1000	PA, CA, TN
230771	927990483022	046677230777	14W/830 Min Bipin T5 HE ALTO UNP/40	Miniature Bipin	1,350	3,000	40/5280	PA
230797	927990483522	046677230791	14W/835 Min Bipin T5 HE ALTO UNP/40	Miniature Bipin	1,350	3,500	40/4000	PA, CA, TN
230805	927990484022	046677230807	14W/841 Min Bipin T5 HE ALTO UNP/40	Miniature Bipin	1,350	4,200	40/8640	PA, CA, TN
230847	927990683022	046677230845	28W/830 Min Bipin T5 HE ALTO UNP/40	Miniature Bipin	2,900	3,000	40/2000	PA, TN
230854	927990683522	046677230852	28W/835 Min Bipin T5 HE ALTO UNP/40	Miniature Bipin	2,900	3,500	40/2640	PA, CA, TN
230862	927990684022	046677230869	28W/841 Min Bipin T5 HE ALTO UNP/40	Miniature Bipin	2,900	4,000	40/2000	PA, CA, TN
230813	927990883022	046677230814	F21T5/830/ALTO 40PK	Miniature Bipin	2,100	3,000	40/3520	PA
230821	927990883522	046677230821	21W/835 Min Bipin T5 HE ALTO UNP/40	Miniature Bipin	2,100	3,500	40/3520	PA, CA, TN
230839	927990884022	046677230838	F21T5/841/ALTO 40PK	Miniature Bipin	2,100	4,000	40/3520	PA, TN
406314	927991383531	046677406318	F28T5 835 HE EA ALTO 25W	Medium Bipin	2,900	3,500	40/1000	PA
414201	927991385031	046677414207	F28T5 850 HE EA ALTO 25W	Medium Bipin	2,800	5,000	40/1000	PA
220509	927991983531	046677220501	F54T5 835 HO EA ALTO 49W	Miniature Bipin	5,000	3,500	40/4320	PA
220525	927991984031	046677220525	F54T5 841 HO EA ALTO 49W	Miniature Bipin	5,000	4,000	40/2640	PA, CA
406496	927991985031	046677406493	F54T5 850 HO EA ALTO 49W	Miniature Bipin	5,000	5,000	40/2640	PA
290197	927992183022	046677290191	F24T5/830/HO/ALTO 40PK	Miniature Bipin	2,000	3,000	40/8640	PA
290205	927992183522	046677290207	24W/835 Min Bipin T5 HO ALTO UNP	Miniature Bipin	2,000	3,500	40/5280	PA, TN
290213	927992184022	046677290214	24W/841 Min Bipin T5 HO ALTO UNP	Miniature Bipin	2,000	4,000	40/8640	PA, TN
290221	927992683022	046677290221	39W/830 Min Bipin T5 HO ALTO UNP	Miniature Bipin	3,500	3,000	40/3520	PA, TN
290239	927992683522	046677290238	39W/835 Min Bipin T5 HO ALTO UNP	Miniature Bipin	3,500	3,500	40/3520	PA
290254	927992684022	046677290252	39W/841 Min Bipin T5 HO ALTO UNP	Miniature Bipin	3,500	4,000	40/3520	PA, CA
230888	927992783022	046677230883	F35T5/830 40PK	Miniature Bipin	3650	3,000	40/2000	PA
230953	927992784022	046677230951	F35T5/841 40PK	Miniature Bipin	3,650	-	40/2000	PA
417816	927992883531	046677417819	F54T5/835/HO/XEW/ALTO/44W	Medium Bipin	4520	3,500	40/4320	PA
417824	927992884031	046677417826	F54T5/841/HO/XEW/ALTO 44W	Medium Bipin	4520	-	40/2640	TN
417832	927992885031	046677417833	F54T5/850/HO/XEW/ALTO/44W	Medium Bipin	4500	-	40/4320	PA
290262	927993183022	046677290269	54W/830 Min Bipin T5 HO ALTO UNP	Miniature Bipin	5,000	3,000	40/2640	PA
290288	927993183522	046677290283	54W/835 Min Bipin T5 HO ALTO UNP	Miniature Bipin	5,000	3,500	40/2640	PA, TN
290833	927993184022	046677290832	54W/840 Min Bipin T5 HO ALTO UNP	Miniature Bipin	5,000	4,000	40/1000	PA, CA, TN
135103	927993185022	046677135102	F54T5/850/HO/ALTO 40PK	Miniature Bipin	5,000	5,000	40/2640	PA, CA, TN
147454	927993186522	046677147457	F54T5/865/HO/ALTO 40PK	Miniature Bipin	4,750	6,500	40/2640	PA, CA, TN
332411	928000503321	046677114633	F6T5/CW FAM/25	Miniature Bipin	295	-	25/18000	PA, CA
332478	928001003321	046677114640	F8T5/CW PH 25PK	Miniature Bipin	400	-	25/6000	PA, CA, TN
332536	928001503332	046677115142	F13T5/CW PH 25PK	Miniature Bipin	820	4,100	25/4000	PA, TN
207035	928001508332	046677207038	F13T5/30U 25PK	Miniature Bipin	1,000	3,000	25/4000	PA
<b>T5 Circular Fluorescent Lamp</b>								
166017	927965083013	8711500640956	MASTER TL5 Circular 22W/830 1CT/10	2GX13	1,800	3,000	10/450	PA, TN
166009	927965084013	8711500642219	MASTER TL5 Circular 22W/840 1CT/10	2GX13	1,800	4,000	10/450	TN
165936	927965783013	8711500642790	MASTER TL5 Circular 55W/830 1CT/10	2GX13	4,200	3,000	10/270	PA, TN
165928	927965784013	8711500642516	MASTER TL5 Circular 55W/840 1CT/10	2GX13	4,200	4,000	10/180	PA, TN



## HID Lamps

### High Intensity Discharge



### Why choose High Intensity Discharge (HID) lamps?

- Use HID lamps in existing fixtures for easy relamping option
- Non-cycling HPS lamp life up to 40K hours (based on 10 hours per start)
- Low wattage CDM (Ceramic Metal Halide) lamps have excellent color - up to 92CRI and are available in compact sizes
- Energy Advantage CDM Lamp with AllStart Technology can be used in probe pulse start metal halide ballasts

### High Intensity Discharge (HID) lamps

Catalog Number	Model Number	UPC Code	Product Description	Base	Lumens	CCT (K)	Case/Pallet Qty	Dist. Center
MasterColor Ceramic Metal Halide								
434183	928050000615	046677434182	MC CDM-R Elite 35W/930 E26 PAR20 10D	Medium Screw	2000	3,000	12/1620	PA
434191	928050100615	046677434199	MC CDM-R Elite 35W/930 E26 PAR20 30D	Medium Screw	2000	3,000	12/1620	PA, TN
231605	928082205115	046677231606	CDM-TD 70W/830 RX7s T6 CL	Recessed Single Contact	5750	3,000	12/1872	PA
223370	928082305115	046677223373	CDM-T 70W/830 G12 T6 CL	G12	6600	3,070	12/2592	PA, TN
223289	928083105115	046677223281	CDM-T 35W/830 G12 T6 CL	G12	3300	3,000	12/2592	PA, TN
232728	928083705115	046677232726	CDM150/T6/830 12PK	G12	14000	3,000	12/2592	PA, TN
281378	928084505115	046677281373	CDM-T 70W/942 G12 T6 CL	G12	6600	4,200	12/2592	PA
373696	928084605115	046677373696	CDM150/T6/942 12PK	G12	12700	4,200	12/2592	PA
373720	928085205115	046677373726	CDM-TC 35W/830 G8.5 T4 CL	G8.5	3300	3,000	12/2592	PA, TN
373738	928086505115	046677373733	CDM-TC 70W/830 G8.5 T4 CL	G8.5	6400	3,000	12/2592	PA, TN
140400	928087905115	046677140403	CDM20/TM/830 12PK	PGJ5	1650	3,000	12/2592	PA
211391	928093905115	046677211394	CDM 35/TM/930	PGJ5	3000	3,000	12/2592	PA, TN
208835	928099905115	046677208837	CDM-TC 35W/842 G8.5.1CT/12	G8.5	3300	4,200	12/2592	PA, TN
426452	928108300615	046677426453	MC CDM-R Elite 35W/930 E26 PAR30L 10D	Medium Screw	2700	3,000	6/588	PA
426486	928108400615	046677426484	MC CDM-R Elite 35W/930 E26 PAR30L 30D	Medium Screw	2700	3,000	6/588	PA
426528	928109600615	046677426521	MC CDM-R Elite 70W/930 E26 PAR30L 10D	Medium Screw	4900	3,000	6/588	PA
426544	928109800615	046677426545	MC CDM-R Elite 70W/930 E26 PAR30L 40D	Medium Screw	4900	3,000	6/588	PA
410472	928183305115	046677410476	MC CDM-T Elite 20W/830 G12 T6 CL 1CT/12	Miniature Bipin	1800	3,000	12/2592	PA, CA, TN
410464	928183405115	046677410469	CDM20/TC/830 Elite	Miniature Bipin	1800	3,000	12/2592	PA, TN
408500	928183505115	046677408503	MC CDM-Tm Elite Mini 20W/830 GU6.5 1CT	GU6.5	18000	-	12/2592	PA, TN
409144	928185205115	046677409142	MASTERColor CDM-T Elite 35W/930 G12 1CT	G12	4000	3,000	12/2592	PA, TN
409151	928185305115	046677409159	MASTERColor CDM-T Elite 70W/930 G12 1CT	G12	7650	3,000	12/2592	PA
418798	928187405115	046677418793	MASTERC CDM-Tm Elite Mini 35W/930 GU6.5	GU6.5	3900	2,900	12/2592	PA
409169	928189105115	046677409166	MASTERColor CDM-TC Elite 35W/930 G8.5	G8.5	4000	3,000	12/2592	PA, TN
421651	928191005315	046677421656	CDM-Rm Elite Mini 20W/830 GX10 MR16 10D	GX10	1050	3,000	12/2220	PA, TN
421669	928191105315	046677421663	CDM-Rm Elite Mini 20W/830 GX10 MR16 25D	GX10	1050	3,000	12/2220	PA, CA, TN

● Stock Ready (returnable)

## HID Lamps

### High Intensity Discharge



(continued)

Catalog Number	Model Number	UPC Code	Product Description	Base	Lumens	CCT (K)	Case/Pallet Qty	Dist. Center
<b>MasterColor Ceramic Metal Halide (continued)</b>								
421677	928191205315	046677421670	CDM-Rm Elite Mini 20W/830 GX10 MR16 40D	GX10	1050	3,000	12/2220	PA
418939	928194605315	046677418939	CDM-Rm Elite Mini 35W/930 GX10 MR16 10D	GX10	2400	3,000	12/2220	PA
418947	928194705315	046677418946	CDM-Rm Elite Mini 35W/930 GX10 MR16 25D	GX10	2400	3,000	12/2220	PA
430728	928195305306	046677430726	MASTERC CDM-R111 Elite 35W/930 GX8.5 10D	GX8.5	1450	3,000	6/672	PA
430736	928195405306	046677430733	MASTERC CDM-R111 Elite 35W/930 GX8.5 24D	GX8.5	1800	3,000	6/672	PA
430769	928195705306	046677430764	MASTERC CDM-R111 Elite 70W/930 GX8.5 24D	GX8.5	3700	3,000	6/672	PA
456475	928493630901	046677456474	CDM70/PAR38/FL/3K ALTO ELITE 12PK	Medium Screw	4800	3,000	12/540	TN
456517	928494030901	046677456511	CDM100/PAR38/FL/3K ALTO ELITE 12PK	Medium Screw	6800	-	12/540	TN
456533	928494230901	046677456535	CDM100/PAR38/FL/4K ALTO ELITE 12PK	Medium Screw	5400	4,200	12/540	PA
151431	928601158601	046677151430	CDM70 PAR30L/M/FL/4K (942)	Medium Screw	4,300	4,200	6/588	PA
377200	928601170401	046677377205	MHC150/U/M/4K ALTO 12PK	Medium Screw	13,000	4,000	12/864	PA, CA, TN
134635	928601171501	046677134631	MHC150/U/MP/3K ALTO 12PK	Medium Screw	12,900	3,000	12/864	PA, TN
377242	928601171701	046677377243	MHC150/U/MP/4K ALTO 12PK	Medium Screw	12,000	4,000	12/864	TN
154948	928601172101	046677154943	CDM150/U/PS/4K ALTO 12PK	MOG	13,000	4,000	12/432	PA
419473	928601173302	046677419479	MHC70/U/M/3K ELITE	Medium Screw	7700	3,000	12/864	PA, TN
419515	928601173502	046677419516	MHC100/U/M/3K ELITE	Medium Screw	10150	3,000	12/864	PA, CA, TN
423681	928601173701	046677423681	MHC50/U/MP/3K ELITE	Medium Screw	4800	3,000	12/864	PA, TN
423707	928601173801	046677423704	MHC70/U/MP/3K ELITE	Medium Screw	6700	2,900	12/864	PA, CA, TN
423699	928601173901	046677423698	MHC70/C/U/MP/3K ELITE	Medium Screw	6100	2,900	12/864	PA
423673	928601174001	046677423674	MHC100/U/MP/3K ELITE	Medium Screw	10000	3,000	12/864	PA, CA, TN
423715	928601174101	046677423711	MHC100/C/U/MP/3K ELITE	Medium Screw	9200	3,000	12/864	PA, CA, TN
429928	928601177201	046677429928	MHC50/U/M/4K ELITE	Medium Screw	5100	4,200	12/864	PA, TN
429902	928601177401	046677429904	MHC70/U/M/4K ELITE	Medium Screw	7100	4,200	12/864	PA, CA, TN
429910	928601177501	046677429911	MHC70/C/U/M/4K ELITE	Medium Screw	6800	4,200	12/864	PA
429886	928601177601	046677429881	MHC100/U/M/4K ELITE	Medium Screw	10500	4,200	12/864	CA, TN
429894	928601177701	046677429898	MHC100/C/U/M/4K ELITE	Medium Screw	9800	4,200	12/864	PA
429944	928601177801	046677429942	MHC50/U/MP/4K ELITE	Medium Screw	5,000	4,000	12/864	TN
429950	928601177901	046677429959	MHC70/U/MP/4K ELITE	Medium Screw	6,500	4,000	12/864	TN
429976	928601178001	046677429973	MHC70/C/U/MP/4K ELITE	Medium Screw	6,200	4,000	12/864	PA
429936	928601178101	046677429935	MHC100/U/MP/4K ELITE	Medium Screw	10,000	4,000	12/864	PA, TN
429968	928601178201	046677429966	MHC100/C/U/MP/4K ELITE	Medium Screw	9,500	4,000	12/864	PA, TN
430686	928601178401	046677430689	CDM100/U/PS/4K ED23.5 - Elite	MOG	9,900	4,180	12/432	TN
443072	928601178501	046677430702	MHC100/U/HR/4K ED28 - Elite	MOG	10000	4,080	12/288	PA
<b>AllStart Energy Advantage Ceramic Metal Halide Lamps</b>								
232595	928601165903	046677232597	Allstart Energy Adv 330W ED37 CL 1SL	Ext. Eyelet Excl. Mogul base	36000	4,000	6/144	TN
232561	928601166003	046677232566	CDM205/U/O/4K/EA/ED28	Ext. Eyelet Excl. Mogul base	20500	4,100	12/288	PA, CA, TN
236935	928601166803	046677236939	330W ED37 CO Allstart 1SL	Ext. Eyelet Excl. Mogul base	31000	4,000	6/144	CA
411058	928601168202	046677411053	CDM330/U/O/4K/ED28 EA ALLSTART	Twist	33000	3,900	12/288	PA, TN
411074	928601168302	046677411077	CDM145/U/O/4K/ED28 EA ALLSTART	Twist	13775	4,050	12/288	PA, TN
<b>Ceramalux Dual Arc High Pressure Sodium Lamps</b>								
376889	928601145401	046677376888	400W C400S51/2 Dual Arc Hp Lamp	MOG	49,000	2,100	12/288	PA, CA, TN
377176	928601145501	046677377175	C250S50/2 12PK	MOG	27,500	2,100	12/288	PA, TN
265611	928601145601	046677265618	C150S55/2 12PK	Mogul	15,600	2,100	12/672	PA
265603	928601145701	046677265601	C100S54/2 12PK	MOG	9,100	2,150	12/672	PA, CA
<b>Ceramalux High Pressure Sodium Lamps</b>								
368837	928601139205	046677368838	C1000S52/ALTO	MOG	130000	2,100	6/240	PA, CA, TN
467373	928601139391	046677467371	SON 400W E39 ED58 CL SL/12	MOG	50000	2,100	12/432	PA, CA, TN
467217	928601139490	046677467210	SON 250W E39 ED58 CL SL/12	MOG	27000	2,100	12/432	PA, CA, TN
467225	928601139590	046677467227	C200S66/ALTO 12PK	MOG	21400	2,050	12/432	PA
467233	928601139790	046677467234	SON 150W E39 ED75 CL SL/12	MOG	15800	2,100	12/960	PA, CA, TN
467241	928601139890	046677467241	SON 100W E39 ED75 CL SL/12	MOG	9400	2,100	12/960	PA, CA, TN
467258	928601139990	046677467258	SON 70W E39 ED75 CL SL/12	MOG	6500	2,100	12/960	PA, CA, TN
467266	928601140090	046677467265	C50S68/ALTO 12PK	MOG	4000	2,100	12/960	PA
323865	928601140701	046677323868	C1000S52/ED37 6PK	MOG	125,000	2,100	6/144	PA, CA, TN
467274	928601143590	046677467272	C100S54/M PH 12PK	Medium Screw	9500	2,100	12/2268	PA, TN
467282	928601144190	046677467289	C70S62/M PH 12PK	Medium Screw	6500	2,100	12/2268	PA, CA, TN
467308	928601144990	046677467302	C50S68/M 12pk	Medium Screw	4000	2,100	12/2268	PA, CA, TN
467316	928601147490	046677467319	SON 150W E26 BD54 CL SL/12	Medium Screw	16000	2,100	12/2268	PA, CA, TN

● Stock Ready (returnable)

## HID Lamps

### High Intensity Discharge



(continued)

Catalog Number	Model Number	UPC Code	Product Description	Base	Lumens	CCT (K)	Case/Pallet Qty	Dist. Center
<b>Ceramalux Non-Cycling High Pressure Sodium Lamps</b>								
467324	928601155990	046677467326	C70S62/ALTO NC HPS 12PK	MOG	6300	2,100	12/960	TN
467332	928601156090	046677467333	C150S55/ALTO NC HPS 12PK	MOG	16000	2,100	12/960	PA, TN
467340	928601156190	046677467340	C250S50/ALTO NC HPS 12PK	MOG	29000	2,100	12/432	PA
467357	928601156290	046677467357	C100S54/ALTO NC HPS 12PK	MOG	10000	2,100	12/960	TN
467365	928601156390	046677467364	C400S51/ALTO NC HPS 12PK	MOG	49000	2,100	12/432	PA, CA, TN
<b>CosmoWhite Metal Halide Lamps</b>								
157313	928088505105	046677157319	CPO-TW 60W/728 White PGZ12	PGZ12	7200	2,800	12/2772	PA, TN
157321	928088805105	046677157326	CPO-TW 140W/728 White PGZ12	PGZ12	16500	2,860	12/2376	PA
406041	928093505105	046677406042	CPO-TW 90W/728 White PGZ12	PGZ12	10450	2,750	12/2376	PA
<b>Elite Medium Wattage Metal Halide Lamps</b>								
220624	928492600006	046677220624	CDM T9 ELITE 210W/930/U/E NA	2 Pin SE	24150	2,950	12/864	PA
218313	928492800006	046677218317	CDM T9 ELITE 315W/930/U/E NA	2 Pin SE	38700	3,100	12/864	PA
220640	928492900006	046677220648	CDM T9 ELITE 315W/942/U/E NA	2 Pin SE	35500	4,200	12/864	PA
238089	928493100006	046677238087	CDM T12 ELITE 210W/942/U/O NA	2 Pin SE	22800	4,200	12/864	CA
<b>Mercury Vapor Lamps</b>								
319657	928484900091	046677319656	HPL-N 175W E39/41 HG CL.SLV/12	MOG	7,900	6,800	12/480	PA
248146	928485100091	046677248147	HPL-N 250W E39/41 HG.SLV/12	MOG	13,000	3,700	12/480	PA
248427	928485300091	046677248420	HPL-N 400W E39/41 HG.SLV/6	MOG	23,000	3,700	6/216	PA, TN
337139	928485500091	046677337131	HPL-N 100W E39 HG ISL/12	MOG	4,400	3,950	12/720	PA
248054	928601011012	046677248055	H39KC-175/DX FULL CT 12PK	MOG	7,900	4,100	12/480	PA, TN
<b>Metal Halide Lamps</b>								
137513	928485900191	046677137519	MH 100W/640 E26 CL 1SL/24	Medium Screw	9000	4,000	24/1152	PA, CA, TN
313585	928601122311	046677114169	MH175/U/M 12PK	Medium Screw	14000	4,000	12/1428	PA, CA, TN
313593	928601122403	046677313593	MH175/C/U/M 12PK	Medium Screw	13300	3,700	12/1428	PA
360198	928601132003	046677360191	MS1000/BU/BT37/PS 6PK	MOG	115000	4,000	6/216	PA, TN
287334	928601150313	046677287337	MH175/U 12PK	MOG	14000	4,300	12/480	PA, CA, TN
287284	928601150403	046677287283	MH175/C/U 12PK	MOG	13300	3,900	12/480	PA
274845	928601150813	046677274849	MH250/U 12PK	MOG	21000	4,000	12/480	PA, CA, TN
291690	928601150903	046677291693	MH250/C/U 12PK	MOG	20000	3,700	12/480	PA
426023	928601151303	046677426026	MH400/U/ED28 12PK	MOG	36000	4,000	12/384	PA, CA, TN
276626	928601152103	046677276621	MS175/BU/PS 12PK	MOG	17500	3,700	12/480	PA
276618	928601152203	046677276614	MS250/BU/PS 12PK	MOG	25000	4,300	12/480	PA
383810	928601152503	046677383817	MS320/U/PS 12PK	MOG	30000	4,100	12/480	PA, CA, TN
383877	928601152703	046677383879	MS350/BU/PS 6PK	MOG	37000	4,000	6/216	PA
133322	928601157903	046677133320	MP400/BU 6 PK	Ext. Eyelet Excl. Mogul base	40000	4,000	6/216	PA, CA, TN
133348	928601158102	046677133344	MP400/BU/PS 6PK	Ext. Eyelet Excl. Mogul base	41000	3,800	6/216	PA, TN
391011	928601159402	046677391010	MP350/BU/PS 6PK	Ext. Eyelet Excl. Mogul base	35000	4,000	6/216	PA
281196	928601161803	046677281199	MP175/BU 12PK	Ext. Eyelet Excl. Mogul base	14000	4,000	12/480	PA, TN
281246	928601161903	046677281243	MP250/BU 12PK	Ext. Eyelet Excl. Mogul base	21800	3,800	12/480	PA, TN
207563	928601162202	046677207564	MP250/BU/PS 12PK	Ext. Eyelet Excl. Mogul base	23800	3,800	12/480	PA
232520	928601165501	046677232528	PS MH Std 400W/640 CW Mog ED28 1SL	MOG	44,000	4,000	12/480	PA, CA, TN
232538	928601165601	046677232535	PS MH Std 400W/640 CW Mog ED28 1WR	MOG	40,000	4,000	12/480	PA, CA, TN
232801	928601165802	046677232801	MS250/U/PS 12PK	MOG	21000	3,800	12/480	PA, CA, TN
274498	928601172301	046677274498	MH400/U 6PK	MOG	39000	3,900	6/144	PA, CA, TN
432302	928601172403	046677432300	MH400/C/U 6PK	MOGUL END PRONG	34000	3,700	6/216	PA
232835	928601179001	046677232832	MS400/U/PS 6PK	MOG	36000	4,000	6/216	PA, TN
135400	928601179101	046677135409	MS750/BU/PS 6PK	MOG	82000	4,000	6/216	PA
130674	928601179201	046677130671	MP360/BU/EW 6PK	Ext. Eyelet Excl. Mogul base	36,000	4,000	6/216	PA, TN
131623	928601179401	046677131623	MH1500/U 6PK	MOG	17,000	4,000	6/90	PA, CA, TN
281188	928601179601	046677281182	MP1000/BU 6PK	Ext. Eyelet Excl. Mogul base	107,000	3,500	6/90	PA, TN
321505	928601179701	046677321505	MH1000/U/BT37 6PK	MOG	110,000	4,000	6/216	PA, CA, TN
354621	928601179801	046677354626	MH150/U/M 12PK	Medium Screw	12500	4,000	12/1428	PA
415224	928601179901	046677415228	MH1000/U 6PK	MOG	110,000	4,000	6/90	PA, CA, TN

● Stock Ready (returnable)



### Why choose Reflector Halogen lamps?

- Halogen lamps are low cost options to help provide a warm and inviting look and feel
- Lamps are suitable in retail and residential applications
- PAR lamps fit into track and recessed lighting fixtures to provide accent lighting as well as general lighting
- Outdoor PAR38 lamps help provide security lighting in all weather conditions



### Reflector Halogen lamps

Catalog Number	Model Number	UPC Code	Product Description	Base	Lumens	CCT (K)	Case/Pallet Qty	Dist. Center
<b>Halogen Reflector Lamps</b>								
378034	924047217122	046677378035	20MR16/FL36 BAB 50PK	GU5.3	240	3,100	50/6400	PA, CA, TN
378059	924047417122	046677378059	50MR16/FL36 EXN 50PK	GU5.3	850	3,100	50/9350	PA, CA, TN
140566	924047817126	046677140564	35MR16/FL36 50PK	GU5.3	540	3,000	50/6400	PA
140525	924050517130	046677140526	FRA 35W GU5.3 12V MR16 24D CL 1CT/10X5F	GU5.3	690	3,100	50/4950	PA
133974	924065117182	8711500426550	ALU PRO 50W G53 12V 24D 1CT/6	G53	950	3,000	6/1242	TN
531939	924757104903	046677531935	45PAR16/HAL/FL27 120V 15PK	Medium Screw	420	2,900	15/3795	TN
428854	925706336302	046677428853	53PAR38/EVP/FL25 120V 12/1	Medium Screw	920	2,860	12/624	TN
428938	925706536306	046677428938	72PAR38/EVP/FL25 120V 12/1	Medium Screw	1350	2,880	12/468	PA, CA, TN
459255	925706536309	046677459253	72PAR38/EV/FL25 120V 1/6	Medium Screw	1350	2,880	1/84	PA, CA, TN
428920	925706936304	046677428921	53PAR30L/EVP/FL25 120V 15/1	Medium Screw	920	2,860	15/1080	TN
428952	925707036302	046677428952	53PAR30L/EVP/WFL40 120V 15/1	Medium Screw	920	2,860	15/1080	PA, CA, TN
428870	925707136303	046677428877	39PAR30L/EVP/FL25 120V 15/1	Medium Screw	500	2,900	15/960	PA, CA, TN
425207	925707336305	046677425203	39PAR20/EVP/FL25 120V 15/1	Medium Screw	480	2,900	15/2700	PA, CA, TN
425124	925707436302	046677425128	39PAR20/EVP/SP10 120V 15/1	Medium Screw	480	2,900	15/2700	PA
428960	925709736302	046677428969	39PAR30S/EVP/FL25 120V 15/1	Medium Screw	500	2,900	15/1215	PA, CA, TN
428904	925710036302	046677428907	53PAR30S/EVP/FL25 120V 15/1	Medium Screw	920	2,860	15/1350	TN
428986	925714136301	046677428983	53PAR30S/EVP/WFL40 120V 15/1	Medium Screw	920	2,860	15/1350	PA, TN
<b>Halogen A19 Lamp</b>								
409821	925701836301	046677409821	72A19/EV 120V 12/2	Medium Screw	1490	3,000	12/1296	PA, CA, TN
<b>Halogen Capsule Lamp</b>								
442780	924794736381	046677115074	DCBAY 100W 120V ESR 1CT/12	DCBAY	1,600	2,700	12/6888	TN
<b>Halogen Double Ended Lamp</b>								
200105	924735334593	046677100100	PLUS PRO S 500W R7s 120V 1CT/12	R7S	9,500	2,900	12/6360	PA, CA, TN

• Stock Ready (returnable)



### Why choose Incandescent lamps?

- Simple to replace and use in existing applications
- Provides soft white light that end users are familiar with
- Heat lamps will provide warmth where needed
- TuffGuard lamps to help contain glass in case of accidental breakage

### Incandescent lamps

Catalog Number	Model Number	UPC Code	Product Description	Base	Lumens	CCT (K)	Case/Pallet Qty	Dist. Center
<b>Incandescent Reflector Lamps</b>								
389130	920670036324	046677225360	65BR/FL60 120V 24/1	Medium Screw	620	2,700	24/480	PA, CA, TN
225375	920670336103	046677225377	65BR/FL60 130V CDA 24/1	Medium Screw	685	2,700	24/432	TN
143438	920673035502	046677143435	300BR/FL 120/130V 24/1	Medium Screw	2,480	2,700	24/432	PA
248849	920681036112	046677225209	65BR30/FL55 CDA 130V	Medium Screw	450	2,700	12/840	PA, CA, TN
248765	920681036369	046677225193	65BR30/FL55 120V 12/1	Medium Screw	620	2,700	12/840	PA, CA, TN
249029	920681336304	046677227395	75BR30/PK CDA 120V 8/1	Medium Screw	555	2,700	8/840	TN
374322	923834636104	046677374327	Refi 250W Med Skt 120-130V PAR38 FL 1CT	MED SKT	3,100	2,700	12/720	PA
203224	925154436103	046677203221	45R20 130V 12/1	Medium Screw	380	2,700	12/2640	PA, CA, TN
140087	925184436105	046677140083	65BR40/FL 130V 12/1 PRO	Medium Screw	425	2,700	12/432	PA
140079	925190336106	046677140076	65BR30/FL 130V 12/1 PRO	Medium Screw	450	2,700	12/840	PA, CA, TN
<b>Incandescent Exit Sign Lamp</b>								
248534	920603636301	046677248536	20T6-1/2-IF 120V 24PK	Intermediate	150	2,700	24/7200	PA, CA, TN
<b>Incandescent Heat Lamps</b>								
145508	923800836307	046677221911	100PAR38/HEAT/CL 120V 12/1	MED SKT	N/A	2,700	12/540	PA, TN
145516	923813534608	046677116262	175PAR38/HEAT/CL 120V 12/1	MED SKT	N/A	2,700	12/540	PA, CA, TN
<b>Incandescent High Lumen Lamp</b>								
133918	920140734302	046677133917	300M 120/130V 12/1PK	Medium Screw	6,280	2,700	12/1080	PA, CA, TN
<b>Incandescent Rough Service Lamps</b>								
275503	920647046205	046677275501	100A/RS 250V 60PK	Medium Screw	1,030	2,700	60/2160	PA
<b>Incandescent Sign Lamps</b>								
248351	922746134301	046677248352	6S6 120/130V SBP 48PK	Candelabra Screw	39	2,700	48/12480	TN
248153	925161758601	046677248154	15T6 140-150V 24/1	Candelabra Screw	100	2,700	24/10800	TN
<b>Incandescent Silicone Coated Lamps</b>								
149799	925242636303	046677300388	60A/TF 120V 120PK	Medium Screw	N/A	2,700	120/3600	PA, CA, TN
149716	925286736303	046677279851	100A/RS/TF 120-130V 60PK	Medium Screw	N/A	2,700	60/2160	PA, CA, TN
<b>Incandescent Traffic Sign Lamps</b>								
222042	925285536103	046677222048	69A21/TS 130V 120PK	Medium Screw	660	2,700	120/2400	TN
224857	925287036102	046677224851	116A21/TS 130V 120PK	Medium Screw	1,180	2,700	120/2400	TN
224832	925287036302	046677224837	116A21/TS 120V 120PK	Medium Screw	1,180	2,700	120/2400	TN

• Stock Ready

# Drivers & Ballasts

## Lamps

### Advance drivers

- Centium TLED Driver
- Xitanium LED Indoor Linear Driver
- Xitanium LED Indoor Point Driver
- Xitanium LED Outdoor Driver
- Xitanium LED Outdoor & Highbay Driver

### Advance ballasts

- Ambistar Ballast
- IntelliVolt Ballast
- Magnetic HID Ballast
- Mark 7 Ballast
- Mark 10 Ballast
- Optanium Ballast
- ROVR Ballast
- SignPro Ballast
- SmartMate Ballast



## Advance LED Drivers

**Advance Xitanium LED drivers set the standard for performance**

Slim profile housing enables easy design-in with excellent thermal performance.

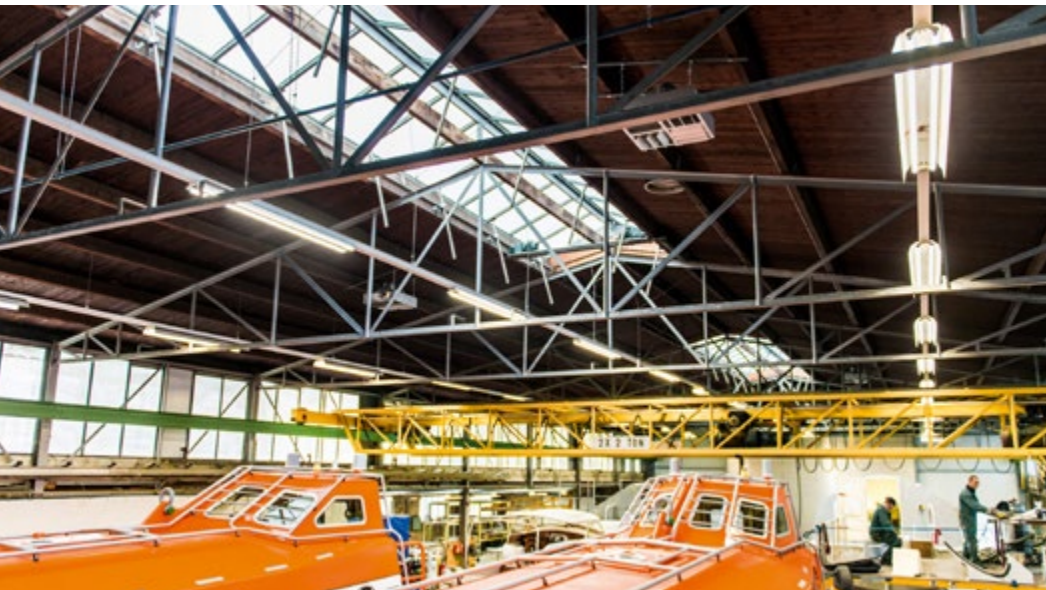

### Why choose Advance LED Drivers & Ballasts?

- Enables simple, fast, flexible application-specific configurations for both indoor and outdoor applications
- Enables fixture designs with comprehensive application coverage for various loads and lumen levels
- Wide operating windows and simple current adjustability for ease of luminaire design
- Broad selection in terms of power, input main voltage and can sizes

### Advance LED drivers

Catalog Number	Model Number	Product Description	Compliance	Dimming	Distribution Center
<b>Xitanium Indoor Point Driver</b>					
■ XI036C100V054DSM1	929000748413	XITANIUM 36W 1.0A 54V 0-10V SSET 1% BE	Title 24	1%	PA, CA, TN
<b>Xitanium Indoor Linear Driver</b>					
■ XI020C056V054BST2	929000754913	XITANIUM 20W 0.1-0.56A 54V 0-10V INT-T	Title 24	1%	PA, CA, TN
■ XI054C150V054BST1	929000752513	XITANIUM 54W 0.1-1.5A 54V 0-10V INT-T	Title 24	1%	PA, CA, TN
■ XI075C200V054BST1	929000755113	XITANIUM 75W 0.1-2.0A 54V 0-10V INT-T	Title 24	1%	PA, CA, TN
■ XI050C140V054BST1	929001723713	Xitanium 50W Linear Gen 2 non-Aux	Title 24	1%	PA, CA, TN
<b>Xitanium Outdoor Driver</b>					
■ XI055C180V054BSJ1	929000795213	XITANIUM 55W 0.1-1.8A SS 120-277V J 6KV	Title 24	10%	PA, CA, TN
<b>Xitanium Outdoor and Highbay Driver</b>					
■ XI095C275V054BSF1	929000780513	XITANIUM 95W 0.1-2.75A 54V SS INT -F 6KV	Title 24	5%	CA
■ XI180C125V200BSF1	929000749513	XITANIUM 180W 0.1-1.25A 200V SS INT -F	Title 24	10%	PA, CA, TN
<b>Centium TLED Driver</b>					
● ICN2P13TLEDN35M	913701269202	TLED Driver (2) 13W T8 120-277V	DLC, UL, CSA, RoHS	-	TN, CA, PA, TX
● ICN2P15TLEDN	913701269502	TLED Driver (2) 13W T8 120-277V	DLC, UL, CSA, RoHS	-	TN, CA, PA, TX
● ICN2P16TLEDLN35M	913701267102	TLED Driver (2) 16W T8 120-277V	DLC, UL, CSA, RoHS	-	TN, CA, PA, TX
● ICN2P16TLEDHLN35M	913701267002	TLED Driver (2) 16W T8 120-277V	DLC, UL, CSA, RoHS	-	TN, CA, PA, TX
● ICN2P16TLEDN35M	913701265702	TLED Driver (2) 16W T8 120-277V	DLC, UL, CSA, RoHS	-	TN, CA, PA, TX
● ICN2P35TLEDN35M	929001790813	TLED Driver (2) 35W T5 120-277V	DLC, UL, CSA, RoHS	-	TN, CA, PA, TX
● ICN3P13TLEDN35M	913701269302	TLED Driver (2) 13W T8 120-277V	DLC, UL, CSA, RoHS	-	TN, CA, PA, TX
● ICN3P15TLEDN35M	913701269602	TLED Driver (2) 15W T8 120-277V	DLC, UL, CSA, RoHS	-	TN, CA, PA, TX
● ICN3P16TLEDN35M	913701266402	TLED Driver (2) 16W T8 120-277V	DLC, UL, CSA, RoHS	-	TN, CA, PA, TX
● ICN4S24TLED90C2LSG35M	913701268802	TLED Driver (2) 24W T5HO 120-277V	DLC, UL, CSA, RoHS	-	TN, CA, PA, TX
● ICN4P13TLEDN35M	913701269402	TLED Driver (2) 13W T8 120-277V	DLC, UL, CSA, RoHS	-	TN, CA, PA, TX
● ICN4P16TLEDHSC	913701266902	TLED Driver (2) 16W T8 120-277V	DLC, UL, CSA, RoHS	-	TN, CA, PA, TX
● ICN4P16TLEDN	913701265802	TLED Driver (2) 16W T8 120-277V	DLC, UL, CSA, RoHS	-	TN, CA, PA, TX

● Stock Ready (returnable)

## Advance LED Ballasts



### Advance LED ballasts

Catalog Number	Model Number	Product Description	Compliance	Dimming	Distribution Center
<b>Ambistar Ballast</b>					
RELB2S40N35I	913701218101	ELE BALLAST (2) F40T12 120V	UL, CSA, RoHS	-	TN, CA, PA, TX
<b>IntelliVolt Ballast</b>					
ICN1P32N35I	913710852301	ELE BALLAST (1) F32T8 120-277V	UL, CSA, RoHS	-	TN, CA, PA, TX
ICN2P32N35I	913710842701	ELE BALLAST (2) F32T8 120-277V	UL, CSA, RoHS	-	TN, CA, PA, TX
ICN3P32N35I	913701220201	ELE BALLAST (3) F32T8 120-277V	UL, CSA, RoHS	-	TN, CA, PA, TX
ICN4P32N35I	913701220301	ELE BALLAST (4) F32T8 120-277V	UL, CSA, RoHS	-	TN, CA, PA, TX
ICN2S40N35I	913710855801	ELE BALLAST (2) F40T12 120-277V	UL, CSA, RoHS	-	TN, CA, PA, TX
ICN2P60N35I	913701261901	ELE BALLAST (2) F96T12 120-277V	UL, CSA, RoHS	-	TN, CA, PA, TX
ICN2S110SC35I	913701212601	ELE BALLAST (2) F96T12/HO 120-277V	UL, CSA, RoHS	-	TN, CA, PA, TX
ICN2S28N35I	913701262101	ELE BALLAST (2) F96T8 120-277V	UL, CSA, RoHS	-	TN, CA, PA, TX
ICN2S24N35M	913701248702	ELE BALLAST (2) F28T5 120-277V	UL, CSA, RoHS	-	TN, CA, PA, TX
ICN2S54N35M	913701235101	ELE BALLAST (2) F54T5/HO 120-277V	UL, CSA, RoHS	-	TN, CA, PA, TX
ICN2S54T35I	913701253301	ELE BALLAST (2) F54T5/HO 120-277V	UL, CSA, RoHS	-	TN, CA, PA, TX
ICN2S24T35I	913701253001	ELE BALLAST (2) F24T5/HO 120-277V	UL, CSA, RoHS	-	TN, CA, PA, TX
ICN2S39T35I	913701253201	ELE BALLAST (2) F39T5/HO 120-277V	UL, CSA, RoHS	-	TN, CA, PA, TX
ICN2S5490CN35I	913701246101	ELE BALLAST (2) F54T5/HO 120-277V	UL, CSA, RoHS	-	TN, CA, PA, TX
ICN2S5490CT35I	913701253401	ELE BALLAST (2) F54T5/HO 120-277V	UL, CSA, RoHS	-	TN, CA, PA, TX
ICN4S5490C2LSG35I	913710268501	ELE BALLAST (4) F54T5/HO 120-277V	UL, CSA, RoHS	-	TN, CA, PA, TX
ICN1S80T35M	913701252902	ELE BALLAST (1) F80T5/HO 120-277V	UL, CSA, RoHS	-	TN, CA, PA, TX
<b>Magnetic HID Ballast</b>					
71A5081001D	913701147701	MH BAL 35/39W M130 120/277V KIT	UL, CSA, RoHS	-	TN, CA, PA, TX
71A5181001D	913710635601	MH BAL 50W M110 120/277V KIT	UL, CSA, RoHS	-	TN, CA, PA, TX
71A5750001D	913700533009	MH BAL 100W M90/140 QUAD KIT	UL, CSA, RoHS	-	TN, CA, PA, TX
71A5752001D	913710606201	MH BAL 150W M102/142 QUAD KIT	UL, CSA, RoHS	-	TN, CA, PA, TX
71A5770001D	913700534109	MH BAL 175W M57 QUAD KIT	UL, CSA, RoHS	-	TN, CA, PA, TX
71A5771001D	913700503051	MH BAL 175W M137/M152 QUAD KIT	UL, CSA, RoHS	-	TN, CA, PA, TX
71A5792001D	913710413801	MH BAL 250W M58 5-TAP KIT	UL, CSA, RoHS	-	TN, CA, PA, TX
71A5892001D	913701122311	MH BAL 250W M138/M153 5-TAP KIT	UL, CSA, RoHS	-	TN, CA, PA, TX
71A6051001D	913700534809	MH BAL 250W M58 QUAD KIT	UL, CSA, RoHS	-	TN, CA, PA, TX
71A6071001D	913700534909	MH BAL 250W M58 QUAD KIT	UL, CSA, RoHS	-	TN, CA, PA, TX
71A6092001D	913710413901	MH BAL 250W M138/M153 QUAD KIT	UL, CSA, RoHS	-	TN, CA, PA, TX
71A6552001	913700535309	MH BAL 320W M132/154 QUAD KIT	UL, CSA, RoHS	-	TN, CA, PA, TX
71A6593001	913710651101	MH BAL 400W M59 5-TAP KIT	UL, CSA, RoHS	-	TN, CA, PA, TX
71A7801001D	913700537609	MH BAL 400W M59 QUAD KIT	UL, CSA, RoHS	-	TN, CA, PA, TX
71A7891001D	913700535809	MH BAL 400W M135/155 QUAD KIT	UL, CSA, RoHS	-	TN, CA, PA, TX
71A7971001D	913710401201	MH BAL 1000W M47 5-TAP KIT	UL, CSA, RoHS	-	TN, CA, PA, TX
71A8071001D	913701121502	MH BAL 1000W M141 5-TAP KIT	UL, CSA, RoHS	-	TN, CA, PA, TX
71A6593001	913710651101	MH BAL 1000W M141 QUAD KIT	UL, CSA, RoHS	-	TN, CA, PA, TX
71A7801001D	913700537609	HPS BAL 50W S68 120/277V KIT	UL, CSA, RoHS	-	TN, CA, PA, TX
71A7891001D	913701115201	HPS BAL 50W S68 QUAD KIT	UL, CSA, RoHS	-	TN, CA, PA, TX
71A7971001D	913700501309	HPS BAL 70W S62 QUAD KIT	UL, CSA, RoHS	-	TN, CA, PA, TX
71A8071001D	913700556409	HPS BAL 100W S54 QUAD KIT	UL, CSA, RoHS	-	TN, CA, PA, TX
71A8172001D	913700556509	HPS BAL 150W S55 QUAD KIT	UL, CSA, RoHS	-	TN, CA, PA, TX
71A8251001D	913710414701	HPS BAL 250W S50 5-TAP KIT	UL, CSA, RoHS	-	TN, CA, PA, TX
71A8271001D	913700556609	HPS BAL 250W S50 QUAD KIT	UL, CSA, RoHS	-	TN, CA, PA, TX
71A8453001D	913710414801	HPS BAL 400W S51 5-TAP KIT	UL, CSA, RoHS	-	TN, CA, PA, TX
71A8753001	913710405501	HPS BAL 1000W S52 5-TAP KIT	UL, CSA, RoHS	-	TN, CA, PA, TX

● Stock Ready (returnable)





## Advance LED Ballasts



### Advance LED ballasts

Catalog Number	Model Number	Product Description	Compliance	Dimming	Distribution Center
<b>Mark 10 Ballast</b>					
● REZ2S32SC35I	913710231601	ELE BALLAST (2) F32T8 120-277V	UL, CSA, RoHS	Yes	TN, CA, PA, TX
● REZ3S32SC35I	913710232101	ELE BALLAST (3) F32T8 120-277V	UL, CSA, RoHS	Yes	TN, CA, PA, TX
● VEZ2S32SC35I	913710251201	ELE BALLAST (2) F32T8 120-277V	UL, CSA, RoHS	Yes	TN, CA, PA, TX
● VEZ3S32SC35I	913710252001	ELE BALLAST (3) F32T8 120-277V	UL, CSA, RoHS	Yes	TN, CA, PA, TX
<b>Mark 7 Ballast</b>					
● IZT2PSP32SC35I	913701260901	ELE BALLAST (2) F32T8 120-277V	UL, CSA, RoHS	Yes	TN, CA, PA, TX
● IZT3PSP32SC35I	913701261701	ELE BALLAST (3) F32T8 120-277V	UL, CSA, RoHS	Yes	TN, CA, PA, TX
● IZT4PSP32G35M	913701251002	ELE BALLAST (4) F32T8 120-277V	UL, CSA, RoHS	Yes	TN, CA, PA, TX
● IZT2S26M5LD35M	913710213702	ELE BALLAST (1) or (2) 26W, (1) 32W, (1) 42W CFL 4P 120-277V	UL, CSA, RoHS	Yes	TN, CA, PA, TX
● IZT2T42M5LD35M	913710291002	ELE BALLAST (2) 26W, (3) 32W, (2) 42W CFL 4P 120-277V	UL, CSA, RoHS	Yes	TN, CA, PA, TX
<b>Optanium Ballast</b>					
● IOPA1P32N35I	913701216101	ELE BALLAST (1) F32T8 120-277V	UL, CSA, RoHS	-	TN, CA, PA, TX
● IOPA2P32N35I	913701216301	ELE BALLAST (2) F32T8 120-277V	UL, CSA, RoHS	-	TN, CA, PA, TX
● IOPA3P32N35I	913701245401	ELE BALLAST (3) F32T8 120-277V	UL, CSA, RoHS	-	TN, CA, PA, TX
● IOPA4P32N35I	913701235501	ELE BALLAST (4) F32T8 120-277V	UL, CSA, RoHS	-	TN, CA, PA, TX
● IOPA1P32LWN35I	913701216001	ELE BALLAST (1) F32T8 120-277V	UL, CSA, RoHS	-	TN, CA, PA, TX
● IOPA2P32LWN35I	913701216202	ELE BALLAST (2) F32T8 120-277V	UL, CSA, RoHS	-	TN, CA, PA, TX
● IOPA3P32LWN35M	913701245502	ELE BALLAST (3) F32T8 120-277V	UL, CSA, RoHS	-	TN, CA, PA, TX
● IOPA4P32LWN35M	913701235602	ELE BALLAST (4) F32T8 120-277V	UL, CSA, RoHS	-	TN, CA, PA, TX
● IOP2P59N35I	913710209004	ELE BALLAST (2) 26W, (3) 32W, (2) 42W CFL 4P 120-277V	UL, CSA, RoHS	-	TN, CA, PA, TX
● IOP1PSP32N35M	913701260402	ELE BALLAST (1) F32T8 120-277V	UL, CSA, RoHS	-	TN, CA, PA, TX
● IOP2PSP32N35I	913701260601	ELE BALLAST (2) F32T8 120-277V	UL, CSA, RoHS	-	TN, CA, PA, TX
● IOP3PSP32SC35I	913710894401	ELE BALLAST (3) F32T8 120-277V	UL, CSA, RoHS	-	TN, CA, PA, TX
● IOP4PSP32SC35I	913710894601	ELE BALLAST (4) F32T8 120-277V	UL, CSA, RoHS	-	TN, CA, PA, TX
● IOP1PSP32LWN35M	913701260502	ELE BALLAST (1) F32T8 120-277V	UL, CSA, RoHS	-	TN, CA, PA, TX
● IOP2PSP32LWN35M	913701260702	ELE BALLAST (2) F32T8 120-277V	UL, CSA, RoHS	-	TN, CA, PA, TX
● IOP3PSP32LWSC35I	913710894301	ELE BALLAST (3) F32T8 120-277V	UL, CSA, RoHS	-	TN, CA, PA, TX
● IOP4PSP32LWSC35I	913710894501	ELE BALLAST (4) F32T8 120-277V	UL, CSA, RoHS	-	TN, CA, PA, TX
<b>ROVR Ballast</b>					
● IDA2S32SC35I	913710265802	ELE BALLAST (2) F32T8 120-277V	UL, CSA, RoHS	Yes	TN, CA, PA, TX
<b>SignPro Ballast</b>					
● ISB021612EI	913701262201	ELE SIGN BAL (1-2) T12HO 2-16FT 120-277V	UL, CSA, RoHS	-	TN, CA, PA, TX
● ISB043214EI	913701262301	ELE SIGN BAL (1-4) T12HO 4-32FT 120-277V	UL, CSA, RoHS	-	TN, CA, PA, TX
● ISB084846EI	913701262401	ELE SIGN BAL (4-6) T12HO 8-48FT 120-277V	UL, CSA, RoHS	-	TN, CA, PA, TX
● ISB104014EI	913701262501	ELE SIGN BAL (1-4) T12HO 10-40FT 120-277V	UL, CSA, RoHS	-	TN, CA, PA, TX
<b>SmartMate Ballast</b>					
● ICF2S13H1LDK	913700500811	ELE BALLAST (1) or (2) 13W CFL 4P 120-277V	UL, CSA, RoHS	-	TN, CA, PA, TX
● ICF2S26H1LDK	913700500821	ELE BALLAST (1) or (2) 18W CFL 4P 120-277V	UL, CSA, RoHS	-	TN, CA, PA, TX
● ICF2S42M2LDK	913700500831	ELE BALLAST (1) or (2) 26W, (1) 32W, (1) 42W CFL 4P 120-277V	UL, CSA, RoHS	-	TN, CA, PA, TX

● Stock Ready (returnable)



© 2021 Signify Holding. All rights reserved. The information provided herein is subject to change, without notice. Signify does not give any representation or warranty as to the accuracy or completeness of the information included herein and shall not be liable for any action in reliance thereon. The information presented in this document is not intended as any commercial offer and does not form part of any quotation or contract, unless otherwise agreed by Signify.

Signify North America Corporation  
400 Crossing Blvd, Suite 600  
Bridgewater, NJ 08807  
Telephone: 855-486-2216

Signify Canada Ltd.  
281 Hillmount Road,  
Markham, ON, Canada L6C 2S3  
Telephone: 800-668-9008

All trademarks are owned by Signify Holding or their respective owners.